



PRODUCT CATALOG



INDEX

Figure numbers are presented for many of our items-however we are prepared to supply based upon your own descriptions or with reference numbers from any industry catalog.

GATE VALVES

	PAGE
Bronze	7-21,34,133
Cast Iron	25-26,34-35
Ductile Iron	39,44
Cast Steel	36,39,44
Forged Steel	48
Metric	123-136
Stainless	53-54,68

GLOBE, ANGLE & STOP CHECK VALVES

Bronze	9-21,133
Cast Iron	27-28,35,64,75,133
Ductile Iron	28,32,75,133
Cast Steel	40-44,75
Forged Steel	49-52,64
Metric	123-136
Stainless	55-56

CHECK VALVES

Bronze	11-14,24,67,86,133
Cast Iron	29-30,35,67
Ductile Iron	33
Cast Steel	43-47,67
Forged Steel	50
Metric	123-126
Stainless	57-58,67

BALL VALVES

65,161

BUTTERFLY VALVES

61-63

HOSE VALVES

21-22,79

METRIC VALVES

123-136

MISCELLANEOUS VALVES

Actuation	60,63
Backflow Preventors	86
Bellmouths	75,186
Blowdown Valves	51-52,84
Boiler Valves	35,41,51-52,83,156
Cocks & Plug Cocks	66,125,133
Control Valves	73,166
Cross Valves	75,86
Deck Drains & Deck Access Boxes	76,172-173
Deck Wash Valves	22
Diaphragm Valves	69
Edwards® Valves	44,51-52
Ejectors/Eductors	75
Emergency Shut-off	84
Flame Screens, Arrestors	70
Fire Valves	21-22,79
Flush Valves	87,174
Foot Valves	86,99
Gaskets & Packing	88,105
Gage Valves	82
Handwheels	60
Hi-Lift Cargo Angle Valves	75
High Pressure Valves	14,43-44,48-52
Hose Valves, Thread Chart	21-22,79
Knife Gate	68
Line Blind & Spectacle Blind	74
Liquid & Boiler Gauges	83
Manifolds	75
Marine Equipment	88
Modifications	59-60
Needle Valves	82
Operators, Options	59-60
Packing & Gaskets	88
Plug Valves	66,125,160
Pressure Vacuum Relief Valves	70
Pressure Reducing Valves	73,164,166
Pressure Seal	43-44
Public Health Valves	86-87
PVC Valves	99

Quick Open & Close Valves	84
Reducers/Regulators	72-73,165-166
Refrigeration Valves	72
Relief & Safety Valves	71,162
Rockwell Edwards® Valves	44,51-52
Safety & Relief Valves	71
Scupper Valves	85,136,175
Sight Feed & Sight Flow	83
Solenoid Valves	84,176
Steam Traps	80,170
Storm Valves	85,136,175
Strainers	81,163
Temperature Regulators	72,167
Testing & Certifications	59
Tomoe® Butterfly	62,135
Union End Valve	13,143-145,153
Vent Check Valves	77
Wafer Checks	67
Water Gauges	83
Y-Globe Valves	43-44,51-52,86

PIPE AND TUBING

109-114,191-193

Hangers, Clamps	116-118
Weld Rings	116
Insulation	116
Couplings	117-118

FITTINGS & FLANGES

89-107

Aluminum, Aluminum Brass	89-93,104
Black Iron	87-90
Brass, Bronze	89-91
Buttweld	92-93
Chrome Plated	90,101,103
Chrome-Moly	91,93
Compression & Bite Type	101,103,107,139
Copper	102
Coppernickel	90-93,180-181,189
Deck Sleeve Penetration	105,107,117-118
Diacoup Couplings	105,117
Dresser® Couplings	105,117
Expansion Joints	115
Fasteners	88
Fiberglass, FRP	100
Flanges ANSI	94,97,102,189-190
Metric	98,140
Dimension Charts	197-203
Flanged Fittings	100
Flare	101,103,139
Forged Steel	90-91
Galvanized	89-91
Grip Couplings, Normaconnect	107,118
High Pressure	90-91
Hose Fittings, Thread Chart	22,78-79
Malleable Iron	89-90
Marine Equipment	88
Metric	98,103-104,107,125
Navy Mil-Spec	177-190
Nipples	90,95
Olets, Bosses	96,184
PVC, CPVC	99
Quick Connect Fittings	106,173
Silbraz	94,177-179
Socket Weld	91,185
Spool Piece	100
Stainless	89-93
Stub Ends	93,97
Tanker Unions	104
Threaded	89-90,185
Tube Fittings	101,104
Weld, Braze, Thd Olets	96
Weld & Dimensions	91-93
Wrot Copper	102
Yorcalbro	104
METALS PROFILES PLATE	119-121
NAVY INDEX MIL-SPEC	141,143-194
DATA INFO CONVERSIONS	122,195-214

For Your Notes

For Your Notes

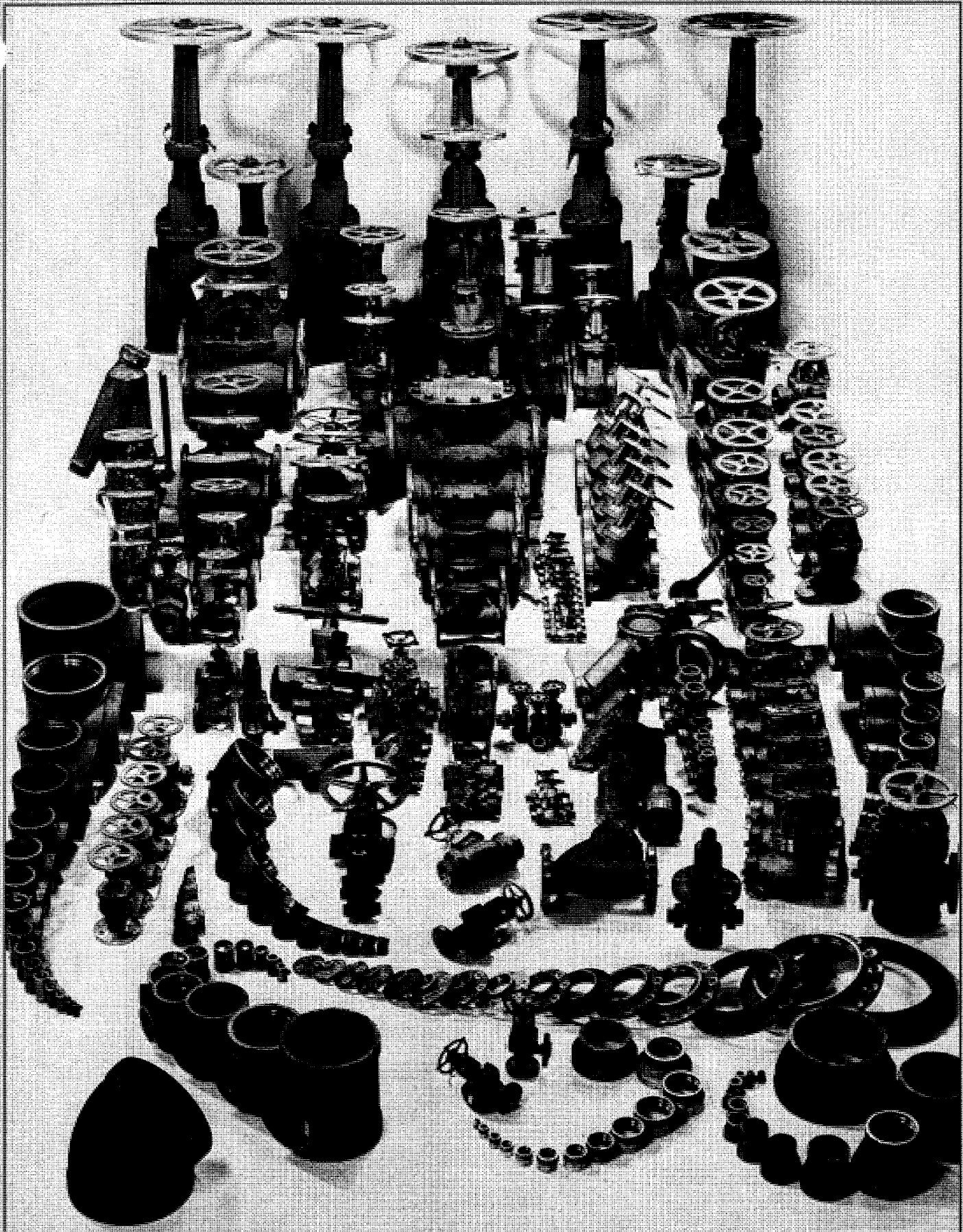

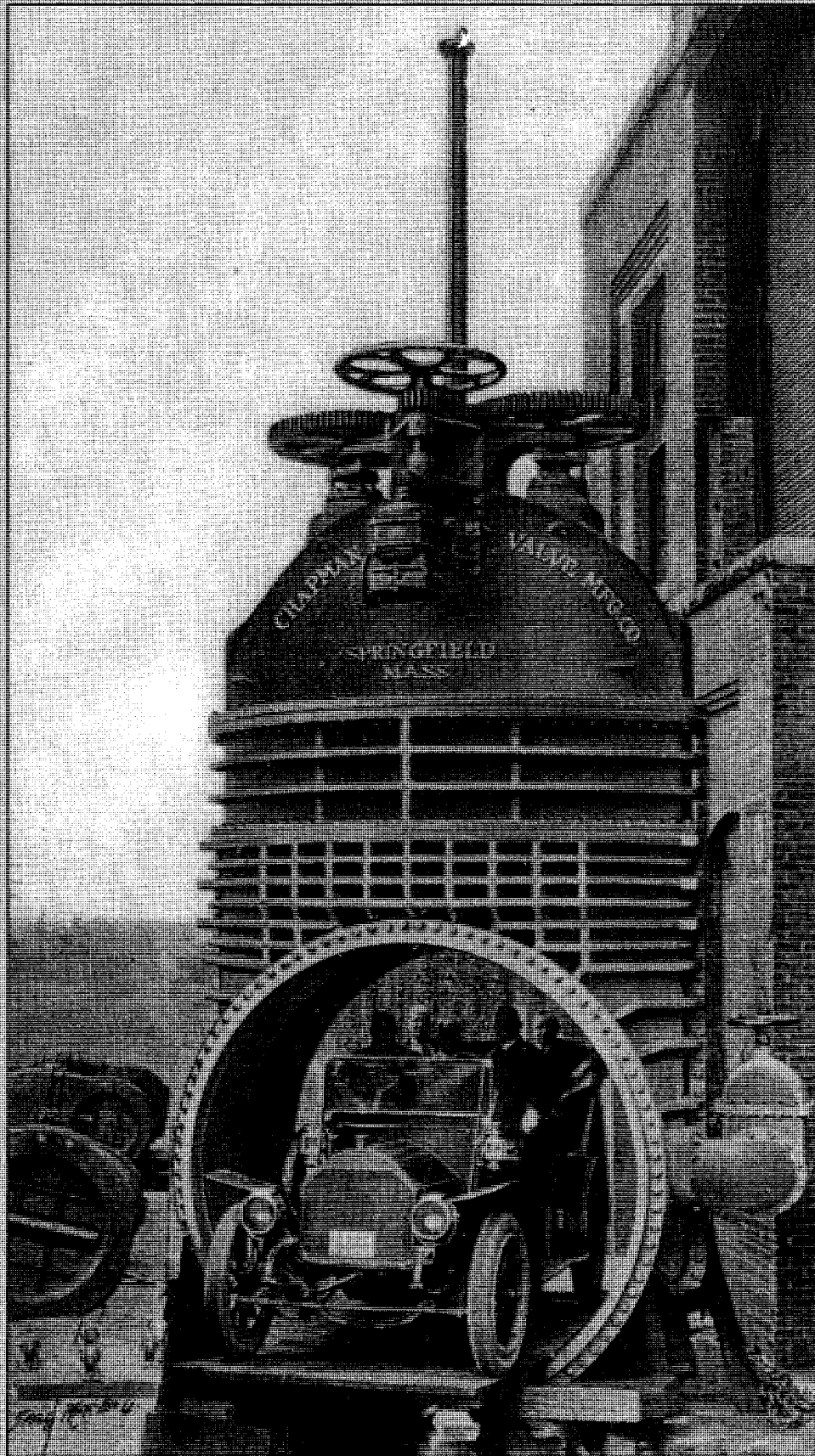

One of five 9 foot (2.73 m) gate valves produced by Chapman Valve Mfg. Co., Springfield, Massachusetts, for installation into Niagara Falls Water Power System of the Ontario Power Co. Overall height 30'3" (9.2m) with a weight of 130,000 lbs. (59,000 kg). Valve operation by 15 horsepower electric motor. 88 bolt holes in flanges. Bypass valve size 14".

BRONZE GATE

125 LB

THREADED or SOLDER JOINT ENDS

SIZES: 1/4" to 4"

DESIGN DESCRIPTION:

Threaded Bonnet
Rising or Non-Rising Stem
Integral Seat

PARTS AND MATERIAL LIST:

DESCRIPTION	MATERIAL	SPECIFICATION
body	bronze	B-62
bonnet	bronze	B-62
disc	bronze	B-62
stem	silicon bronze	B-584
stuffing box	brass	B-16
gland	brass	B-16
packing nut	brass	B-16
packing	non-asbestos	commercial

BRONZE GATE

150 LB

THREADED OR SOLDER JOINT ENDS

SIZES: 1/4" to 3"

DESIGN DESCRIPTION:

Threaded Bonnet
Rising or Non-Rising Stem
Integral Seat

PARTS AND MATERIAL LIST:

DESCRIPTION	MATERIAL	SPECIFICATION
body	bronze	B-62
bonnet	bronze	B-62
disc	bronze	B-62
stem	silicon bronze	B-584
stuffing box	brass	B-16
gland	brass	B-16
packing nut	brass	B-16
packing	non-asbestos	commercial

PRESSURE / TEMPERATURE RATINGS

125 psi wsp 400° F / 200 psi wog 150° F

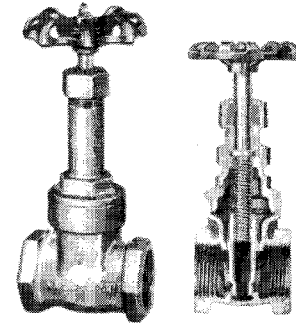

RS
Standard
Economy

NRS
111101
110101



Solder Joint End
191101

PRESSURE / TEMPERATURE RATINGS

150 psi wsp 400° F / 300 psi wog 150° F

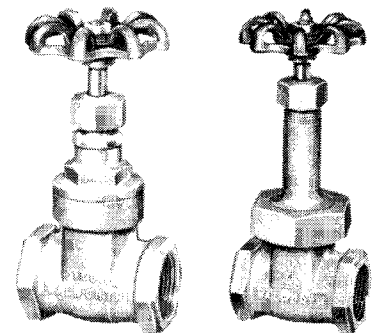

Thread Bonnet
112101

Union Bonnet
112101-UB

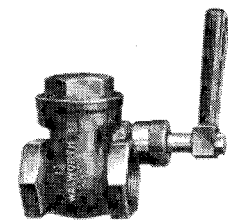

Quick Open Self Close Spring
112151

BRONZE GATE

200 / 300 LB

THREADED ENDS

SIZES: 1/8" to 3"

DESIGN DESCRIPTION:

Union Bonnet
Rising or Non-Rising Stem
Integral Seats

PARTS AND MATERIAL LIST:

DESCRIPTION	MATERIAL	SPECIFICATION
body	bronze	B-62
bonnet	bronze	B-62
disc	bronze	B-62
stem	silicon bronze	B-584
union bonnet ring	bronze	B-62
stuffing nut	brass	B-16
gland	brass	B-16
packing	non-asbestos	commercial

ALLOY TRIM

THREADED ENDS

SIZES: 1/8" to 3"

DESIGN DESCRIPTION:

Union Bonnet
Rising or Non-Rising Stem
Renewable Seats
Monel or Stainless Trim

PARTS AND MATERIAL LIST:

DESCRIPTION	MATERIAL	SPECIFICATION
body	bronze	B-62
bonnet	bronze	B-62
disc	bronze or monel	B-62 or B-164
seat ring	stainless steel or monel	A-582-416 or B-164
stem*	silicon bronze	B-584
union bonnet ring	bronze	B-62
stuffing nut	brass	B-16
gland	brass	B-16
packing	non-asbestos	commercial

*Monel Stem available

PRESSURE / TEMPERATURE RATINGS

200 psi wsp 550° F / 400 psi wog 150° F
300 psi wsp 550° F / 400 psi wog 150° F

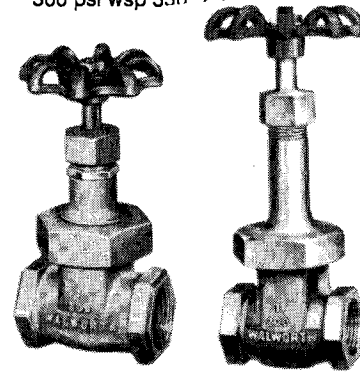

113101 - 200 lb

114101 - 300 lb

113104 - 200 lb Monel Trim
114104 - 300 lb Monel Trim

113107 - 200 lb SS Trim
114107 - 200 lb SS Trim

BRONZE GLOBE & ANGLE 125 LB

THREADED or SOLDER JOINT ENDS

SIZES: 1/8" to 3"

DESIGN DESCRIPTION

Threaded Bonnet
Rising Stem
Stop-check available - see details on page 18

PARTS AND MATERIAL LIST

DESCRIPTION	MATERIAL	SPECIFICATION
body	bronze	B-62
bonnet	bronze	B-62
disc	bronze	B-62
stem	silicon bronze	B-584
disc lock nut	bronze	B-62
packing nut	brass	B-16
gland	brass	B-16
packing	non-asbestos	commercial

BRONZE GLOBE & ANGLE 150 LB

THREADED or SOLDER JOINT ENDS

SIZES: 1/8" to 3"

DESIGN DESCRIPTION

Teflon Disc
Union Bonnet
Rising Stem
Stop-check available - see details on page 18
Needle Type Disc available

PARTS AND MATERIAL LIST:

DESCRIPTION	MATERIAL	SPECIFICATION
body	bronze	B-62
bonnet	bronze	B-62
disc	bronze or teflon	B-62
stem	silicon bronze	B-584
disc lock nut	bronze	B-62
packing nut	brass	B-16
gland	brass	B-16
packing	non-asbestos	commercial

PRESSURE / TEMPERATURE RATINGS

125 psi wsp 400° F / 200 psi wog 150° F

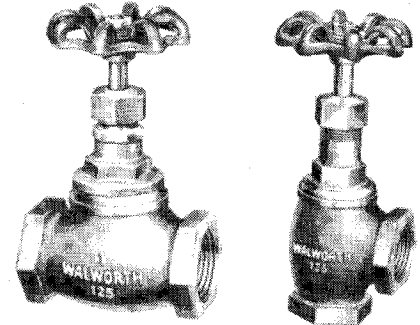

Globe
Standard 111301
Economy 110301

Angle
Standard 111401

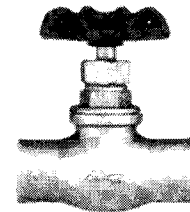

Solder Joint
191301 - Globe
191401 - Angle

PRESSURE / TEMPERATURE RATINGS

150 psi wsp 400° F / 300 psi wog 150° F

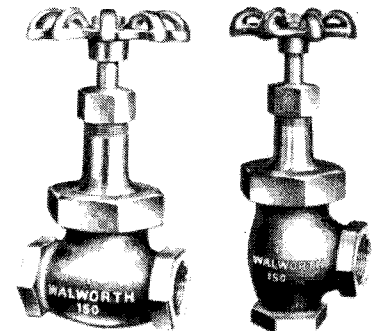

Globe
112301

Angle
112401

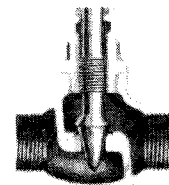

Needle Disc Design
Add "ND" suffix

ALLOY TRIM

THREADED ENDS

SIZES: 1/8" to 3"

DESIGN DESCRIPTION

Union Bonnet
 Rising Stem
 Integral Seat
 Stop-check available see page 18
 Needle Type Disc available

PARTS AND MATERIAL LIST:

DESCRIPTION	MATERIAL	SPECIFICATION
body	bronze	B-61
bonnet	bronze	B-61
bonnet ring	bronze	B-61
disc	bronze	B-61
disc locknut	bronze	B-61
seat rings	bronze	B-61
stem	silicon bronze	B-584
packing nut	brass	B-16
gland	brass	B-16
packing	non-asbestos	commercial

PRESSURE / TEMPERATURE RATINGS

200 psi wsp 550° F / 400 psi wog 150° F
 300 psi wsp 550° F / 600 psi wog 150° F

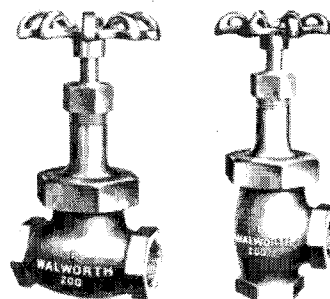

Globe	Angle
200 lb 113301	200 lb 113401
300 lb 114301	300 lb 114401

ALLOY TRIM

THREADED ENDS

SIZES: 1/8" to 3"

DESIGN DESCRIPTION

Union Bonnet
 Rising Stem
 Stainless Steel Plug Disc for Steam Service
 Stainless Steel Renewable Seats
 Monel Trim Also available
 Stop-check available - see page 18

PARTS AND MATERIAL LIST:

DESCRIPTION	MATERIAL	SPECIFICATION
body	bronze	B-61
bonnet	bronze	B-61
bonnet ring	bronze	B-61
disc	stainless steel or monel	type 416 or B-164
disc locknut	bronze	B-61
seat ring	stainless steel	type 420 or B-164
stem	silicon bronze	B-584
packing nut	brass	B-16
gland	brass	B-16
packing	non-asbestos	commercial

PRESSURE / TEMPERATURE RATINGS

200 psi wsp 550°F / 400 psi wog 150° F
 300 psi wsp 550°F / 600 psi wog 150° F

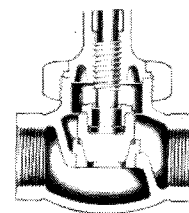

Globe SS Trim	Angle SS Trim
200 lb 113307	200 lb 113407
300 lb 114307	300 lb 114407

Globe Monel Trim	Angle Monel Trim
200 lb 113304	200 lb 113404
300 lb 114304	300 lb 114404

BRONZE SWING CHECK

125 - 150 - 200 - 300 LB

THREADED or SOLDER JOINT ENDS

SIZES: 1/8" to 4"

DESIGN DESCRIPTION

Threaded Cap
Bronze or Teflon Disc
Horizontal or Vertical Installation
Monel Trim available

PARTS AND MATERIAL LIST

DESCRIPTION	MATERIAL	SPECIFICATION
body	bronze	B62
cap	bronze	B62
disc	bronze	B61
hanger	bronze	B61
hanger pin	wrot silicon bronze	B371
disc nut	wrot silicon bronze	B371
side plug	wrot silicon bronze	B371

PRESSURE / TEMPERATURE RATINGS

See Globe Valves pg 9, 10

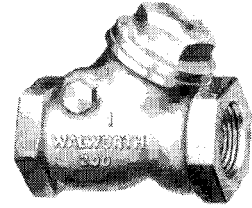

125 lb Standard 111501
125 lb Economy 110501

150 lb 112501
200 lb 113501
300 lb 114501

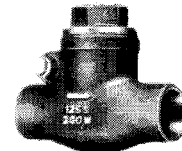

Solder Joint
191501

BRONZE LIFT CHECK

125 - 150 - 200 LB

THREADED ENDS

SIZES: 1/8" to 3"

DESIGN DESCRIPTION

Threaded Cap
Bronze or Teflon Disc
Horizontal Installation

Lift Checks are well adapted to pulsating operation and other services that would cause slamming and possible damage to the discs of swing check valves.

PARTS AND MATERIAL LIST:

DESCRIPTION	MATERIAL	SPECIFICATIONS
body	bronze	B62
cap	bronze	B62
disc	bronze	B62
nut	copper alloy	commercial

PRESSURE / TEMPERATURE RATINGS

See Globe Valves pg 9, 10

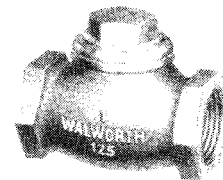

125 lb 111601
150 lb 112601
200 lb 113601

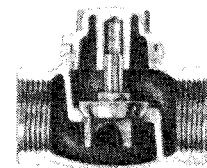

Lift Check Cutaway

BRONZE AIR COMPRESSOR CHECK

THREADED ENDS

SIZES: 1/4" to 2"

DESIGN DESCRIPTION

300 LB Air Pressure
Renewable Stainless Steel Disc

Compressor Check Valves are specially designed for severe operating conditions of air compressor service, but are equally successful in many other air and gas line applications where there is frequent and rapid reversal of flow.

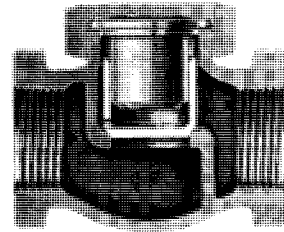

114601

BRONZE BALL CHECK VALVE

THREADED ENDS

SIZES: 1/8" to 2"

DESIGN DESCRIPTION

200 LB WSP, 400 LB WOG

The ball design check is preferred for handling higher viscosity fluids where other types of check valves tend to operate sluggishly.

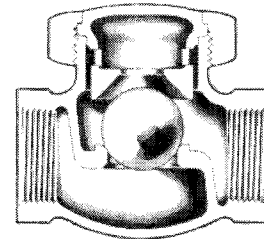

113801

BRONZE VERTICAL LIFT CHECK VALVE

THREADED ENDS

SIZES: 1/8" to 2"

DESIGN DESCRIPTION

125 LB WSP, 250 LB WOG
200 LB WSP, 400 LB WOG

Vertical lift checks are designed for inline vertical installations when swing check is not suitable for service conditions

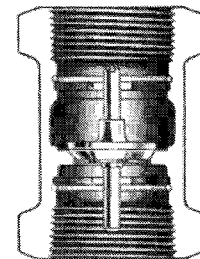

125 lb 111701
150 lb 112701
200 lb 113701

BRONZE UNION END SILBRAZE

SIZES: 1/4" to 2" IPS

DESIGN DESCRIPTION:

Union Ends	1/2" thru 2" size with monel seat rings
Monel Stem and Disc	1/4" and 3/8" sizes with integral bronze seats
Pipe Size Socket Ends	Silbraze tailpieces to MIL-F-1183

PARTS AND MATERIAL LIST:

DESCRIPTION	MATERIAL	SPECIFICATION
body	cast valve bronze	ASTM B61
bonnet	cast valve bronze	ASTM B61
seat ring	ni-cu alloy	QQ-N-288
wedge	ni-cu alloy	QQ-N-288
stem	ni-cu alloy	QQ-N-281
packing gland	phosphor bronze	QQ-B-750
retainer ring	cast valve bronze	ASTM B61
union "O" ring	buna-N rubber	MIL-P-83461
	rubber (EPR)	E515-80 or equal
packing	TFE imp. asbestos	commercial
union nut	cast valve bronze	ASTM B61
union tailpiece	valve bronze	ASTM B61
stuffing box	cast valve bronze	ASTM B61
stuffing nut	cast valve bronze	ASTM B61

OPTIONAL FEATURES:

These valves are normally furnished with bronze silbraze tailpieces. Tailpieces can also be furnished with threaded socketweld or buttweld ends in 90/10 or 70/30 coppernickel, monel, or stainless.

The "O" Rings (one each at the body and tailpiece joint) can be furnished in the following materials:

1. BUNA-N—For oil service.
2. "EPR"—For water, gas or steam service.

Available with lockshield and key.
Available with stem position indicator.

PRESSURE/TEMPERATURE RATINGS

200 psi wsp 425° F
400 psi wog 150° F

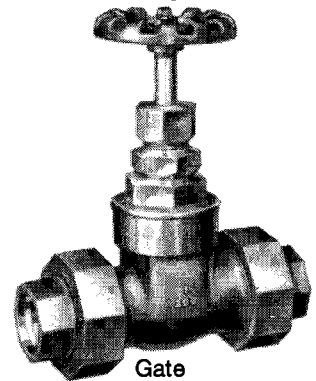

Gate
414101

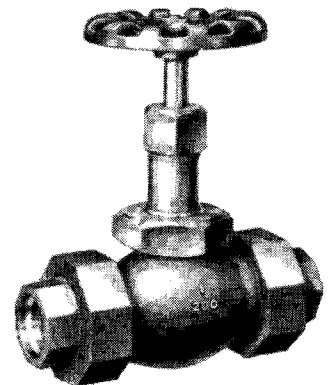

Globe
414301

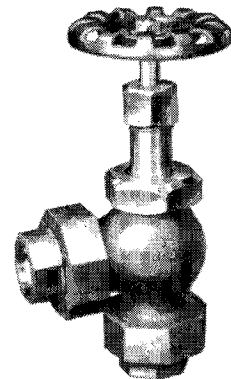

Angle
414401

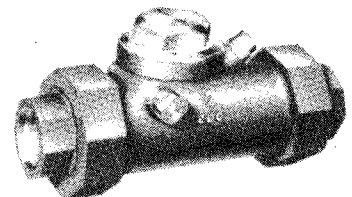

Swing Check
414501

BRONZE WALSEAL

VALVES

125-150-200-300-700 LB

SIZES: 1/4" to 3" IPS

These silbrazed valves are used with IPS sized coppernickel, brass or copper pipe. Silbrazed valves will not join with copper water tube type K, L, M (for these water tubes use solder joint valves). They have a higher pressure and temperature rating than solder joint valves.

To order specify required pressure rating: 125, 150, 200, 300 or 700 PSI

DESIGN DESCRIPTION

Bronze body, bonnet and bonnet ring
Union bonnet
Silbrazed ends for direct brazing

PRESSURE / TEMPERATURE RATINGS

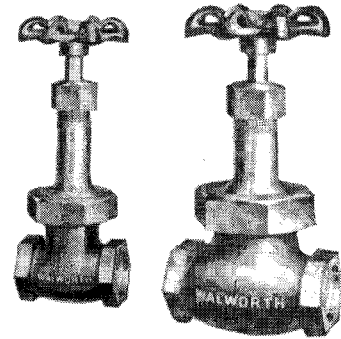

Gate 151101

Globe 151301
Angle 151401

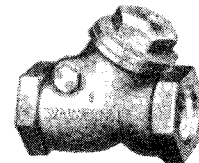

Check
151501

COPPER-NICKEL

GLOBE, ANGLE &

CHECK 700 LB

NAVSEA DWG 2177934

SIZES: 1/4" to 2"

DESIGN DESCRIPTION

Forged copper-nickel 70/30 body and bonnet
Monel trim
Union bonnet
KEL-F disc
Socketweld or silbrazed ends
Flow control device available

PRESSURE / TEMPERATURE RATINGS 700 PSI WOG 250° F

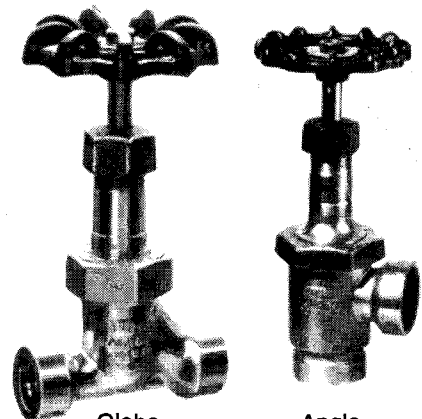

Globe
447301

Angle
447401

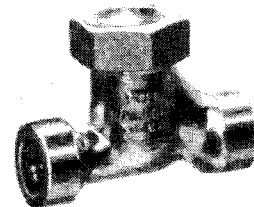

Check
447601

BRONZE GATE FLANGED 150 LB

UNION or THREADED BONNET

SIZES: 1/2" to 3"

DESIGN DESCRIPTION

Rising or Non-rising Stem
Integral Seats
Available with monel trim

PARTS AND MATERIAL LIST:

DESCRIPTION	MATERIAL	SPECIFICATION
body	bronze	B-62
bonnet	bronze	B-62
union bonnet ring	bronze	B-62
stem	silicon bronze	B-584
disc	bronze	B-62
packing nut	brass	B-16
gland	brass	B-16
packing	non-asbestos	commercial
stuffing box (NRS)	brass	B-16

DIMENSIONS (Inches)

SIZE	1/2	3/4	1	1 1/4	1 1/2	2	2 1/2	3
FF	3 3/16	3 1/2	4 1/4	4 9/16	4 3/4	5 1/2	6 1/2	7 1/2
D	3 1/2	3 7/8	4 1/4	4 5/8	5	6	7	7 1/2
BC	2 3/8	2 3/4	3 1/8	3 1/2	3 7/8	4 3/4	5 1/2	6
wt	3	4	7	9	11	18	28	44

BRONZE GATE FLANGED 300 LB

SIZES: 1/2" to 3"

DIMENSIONS (Inches)

SIZE	1/2	3/4	1	1 1/4	1 1/2	2	2 1/2	3
FF*	3 15/16	4 9/16	4 15/16	5 7/16	6 1/4	7 3/4	8 1/2	8 13/16
D	3 3/4	4 5/8	4 7/8	5 1/4	6 1/8	6 1/2	7 1/2	8 1/4
BC	2 5/8	3 1/4	3 1/2	3 7/8	4 1/2	5	5 7/8	6 5/8
wt	5	5	9	13	19	24	37	56



*Note: Face to face dimensions vary by manufacturer

PRESSURE / TEMPERATURE RATINGS
150 psi wsp 400° F / 225 psi wog 150° F

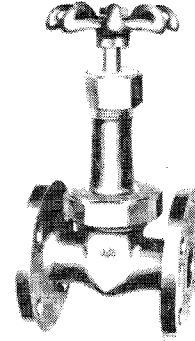

Rising Stem
052102

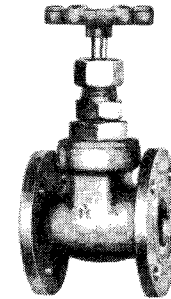

Non-Rising Stem
052102-NRS

PRESSURE / TEMPERATURE RATINGS
300 psi 550° F / 500 psi wog 150° F

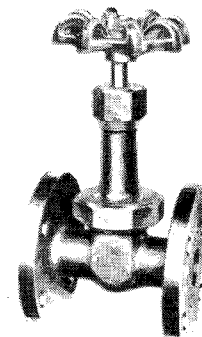

054102

METRIC BRONZE GATE

FLANGED ENDS

DIN or JIS SPECIFICATIONS

SIZES: 15 mm to 250 mm

DIMENSIONS (millimeters)

PN 10/16 DIN (European), THREADED BONNET

SIZE	15	20	25	32	40	50	65	80	100
FF	75	75	80	90	100	110	130	150	160
D	95	105	115	140	150	165	185	200	220
BC	65	75	85	100	110	125	145	160	180
wt(kg)	2	2	3	4	4	5	9	12	19

PN 10/16 DIN (European), BOLTED BONNET

SIZE	40	50	65	80	100	125	150	200	250 (10K)
FF	140	150	170	180	190	200	210	230	250
D	150	165	185	200	220	250	285	340	395
BC	110	125	145	160	180	210	240	295	350
wt(kg)	10	10	15	22	28	37	49	74	105

5K JIS (Japanese) F-7367, UNION BONNET

SIZE	15	20	25	32	40
FF	90	100	110	130	140
D	80	85	95	115	120
BC	60	65	75	90	95
wt(kg)	2	3	4	6	8

10K JIS (Japanese) F-7368, UNION BONNET

SIZE	15	20	25	32	40
FF	100	110	120	140	150
D	95	100	125	135	140
BC	70	75	90	100	105
wt(kg)	3	4	6	8	10

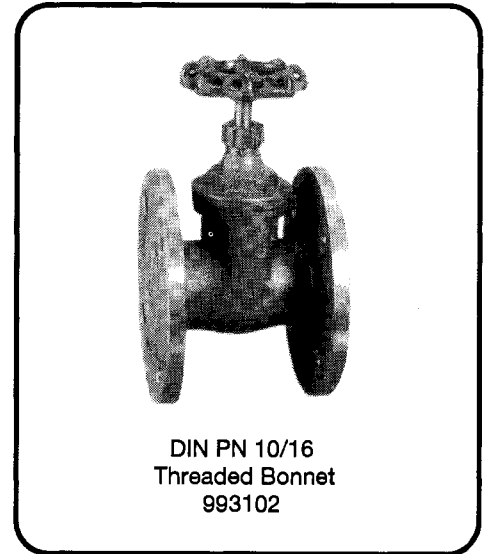
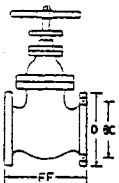

DIN PN 10/16
Threaded Bonnet
993102

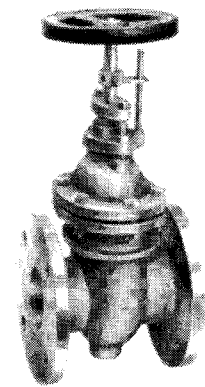

DIN PN 10/16
Bolted Bonnet
993102

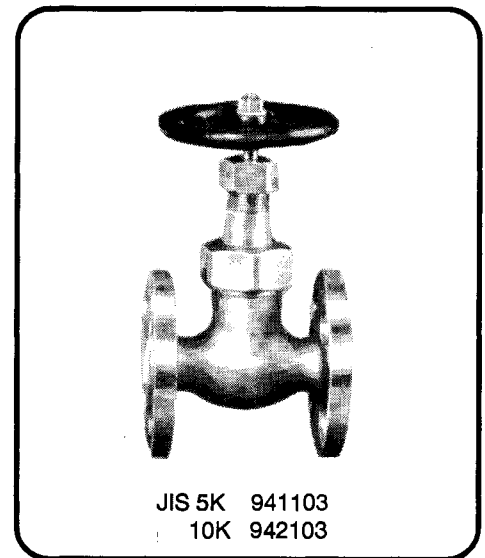

JIS 5K 941103
10K 942103

BRONZE GATE 150 LB FLANGED OSY & NRS

BOLTED BONNET

SIZES: 2" to 24"

DESIGN DESCRIPTION

OSY Rising Stem and Non-rising Stem (NRS)
Bolted Bonnet
Bronze Trim
Renewable Seat Rings
Monel Trim available
Open/closed indicators available on NRS valves

PARTS AND MATERIAL LIST:

DESCRIPTION	MATERIAL	SPECIFICATION
body	bronze	B62
bonnet	bronze	B62
bonnet gasket	non-asbestos	commercial
stem*	wrot brass	B124
disc*	bronze	B62
packing	non-asbestos	commercial
gland	bronze	B62
stuffing box (NRS)	bronze	B62
stuffing box gasket (NRS)	non-asbestos	commercial
seat ring*	bronze	B62
handwheel.	ductile iron	commercial

* available Monel

DIMENSIONS (Inches)

SIZE	2	2 1/2	3	3 1/2	4	5	6	8	10	12
FF	7	7 1/2	8	8 1/2	9	10	10 1/2	11 1/2	13	14
D	6	7	7 1/2	8 1/2	9	10	11	13 1/2	16	19
BC	4 3/4	5 1/2	6	7	7 1/2	8 1/2	9 1/2	11 3/4	14 1/4	17
wt	36	50	67	80	98	131	170	251	387	600

Also available with narrow face-to-face dimension

PRESSURE / TEMPERATURE RATINGS
150 psi wsp 400° F / 225 psi wog 150° F

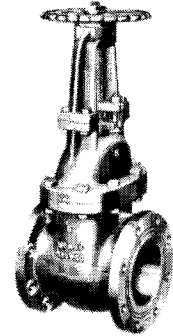

OS&Y
052103 Bronze Trim
052104 Monel Trim

Special Narrow Face to Face
052133

PRESSURE / TEMPERATURE RATINGS
150 psi wsp 400° F / 225 psi wog 150° F

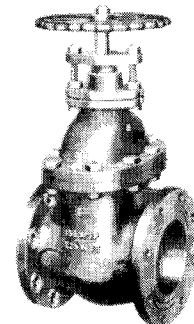

NRS
052203 Bronze Trim
052204 - Monel Trim

Special Narrow Face to Face
052233

BRONZE GLOBE & ANGLE 150 LB FLGD

UNION BONNET

SIZES: 1/2" to 3"

DESIGN DESCRIPTION

Rising stem
Integral seats
Monel Trim available

PARTS AND MATERIAL LIST:

PART	MATERIAL	SPECIFICATION
body	bronze	B-62
bonnet	bronze	B-62
bonnet ring	bronze	B-62
stem	copper-silicon alloy	B-371
disc	bronze	B-62
disc nut	bronze	B-62
packing	non-asbestos	commercial
packing gland	brass	B-16
packing nut	bronze	B-584

DIMENSIONS (Inches)

SIZE	1/2	3/4	1	1 1/4	1 1/2	2	2 1/2	3
*FF	3	3 11/16	4 3/16	4 9/16	5 5/16	6	6 3/4	7 15/16
*CF	2 3/16	2 7/16	2 5/8	2 7/8	3 3/16	3 3/4	4 5/16	4 3/4
D	3 1/2	3 7/8	4 1/4	4 5/8	5	6	7	7 1/2
BC	2 3/8	2 3/4	3 1/8	3 1/2	3 7/8	4 3/4	5 1/2	6
wt	3	5	7	9	12	19	30	40

BRONZE GLOBE & ANGLE 300 LB FLGD

Rising stem
Integral seats
Monel Trim available

DIMENSIONS (Inches)

SIZE	1/2	3/4	1	1 1/4	1 1/2	2	2 1/2	3
*FF	4 3/16	4 11/16	5 3/8	6 1/4	7 1/4	7 1/2	9	10
*CF	2 5/8	3	1/4	3 1/2	4	4 1/4	5 1/8	5 1/4
D	3 3/4	4 5/8	4 7/8	5 1/4	6 1/8	6 1/2	7 1/2	8 1/2
BC	2 5/8	3 1/4	3 1/2	3 7/8	4 1/2	5	5 7/8	6 5/8
wt	7	9	11	14	20	28	40	56

*Note: Face to face and center to face dimensions vary by manufacturer

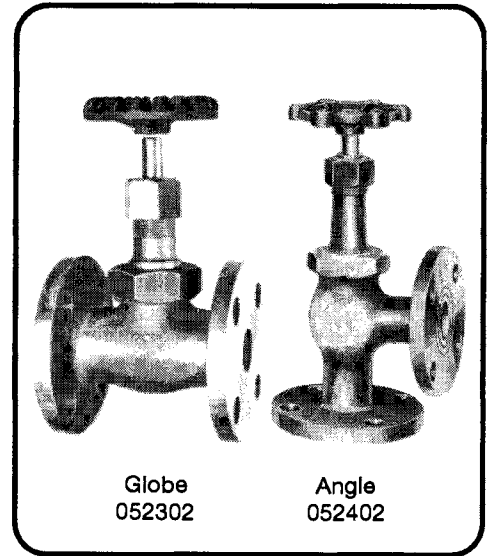

Globe
052302

Angle
052402

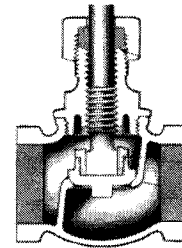

Stop-check feature available

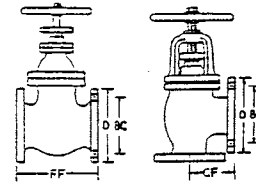

PRESSURE / TEMPERATURE RATINGS
300 psi wsp 500° F / 500 psi wog 150° F

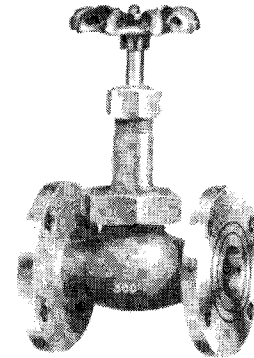

Globe
054303

Angle
054403

BRONZE GLOBE & ANGLE 150 LB FLGD

BOLTED BONNET

SIZES: 1-1/2" to 12"

DESIGN DESCRIPTION

Rising Stem
Bronze Trim
Monel Trim and Stop-check available

PARTS AND MATERIAL LIST:

PART	MATERIAL	SPECIFICATION
Body	bronze	B-62
Bonnet	bronze	B-62
Bonnet gasket	non-asbestos	commercial
Disc*	bronze	B-62
Disc nut	bronze	B-62
Stem*	bronze	B-124
Packing	non-asbestos	commercial
Packing gland	brass	B-16
Packing nut	bronze	B-62
Seat ring*	bronze	B-62

*available in Monel

DIMENSIONS (Inches)

SIZE	1 1/2	2	2 1/2	3	3 1/2	4	5	6	8	10	12
FF	55/16	6	63/4	91/8	101/2	11	123/4	14	191/2	241/2	271/2
CF	33/16	33/4	45/16	45/8	51/4	51/2	63/8	7	93/4	121/4	133/4
D	5	6	7	7 1/2	8 1/2	9	10	11	13 1/2	16	19
BC	37/8	43/4	5 1/2	6	7	7 1/2	8 1/2	9 1/2	11 3/4	14 1/4	17
wt	12	19	29	51	68	80	125	145	315	580	750

Note: Face to face dimensions vary by manufacturer

PRESSURE / TEMPERATURE RATINGS

150 psi wsp 500° F
225 psi wog 150° F

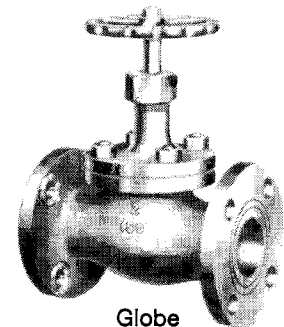

Globe
052303 Bronze Trim
052304 Monel Trim

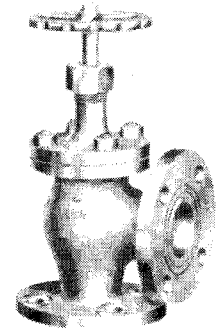

Angle
052403 Bronze Trim
052404 Monel Trim

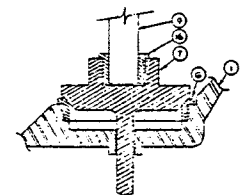
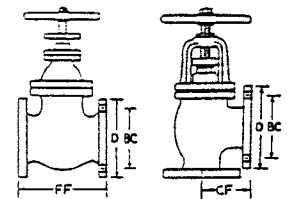

Stop Check Detail

METRIC BRONZE GLOBE & ANGLE

FLANGED ENDS

DIN or JIS SPECIFICATIONS

SIZES: 15 mm to 300 mm

DIMENSIONS (millimeters)

PN 16 DIN (European), UNION BONNET

SIZE	15	20	25	32	40	50	65	80	100
FF	70	80	90	105	120	140	180	200	230
CF	65	70	75	90	100	105	115	125	
D	95	105	115	140	150	165	185	200	220
BC	65	75	85	100	110	125	145	160	180
wt(kg)	2	3	4	6	7	10	12	16	21

PN 10/16 DIN (European), BOLTED BONNET

SIZE	50	65	80	100	125	150	200	250	300
FF	180	200	240	270	320	370	500	730	850
CF	105	115	125	145	170	200	250	325	375
D	165	185	200	220	250	285	340	395	445
BC	125	145	160	180	210	240	295	350	400
wt(kg)	13	23	32	43	65	89	136	217	323

5K JIS (Japanese) GLOBE F-7301, ANGLE F-7302
SCREW DOWN CHECK GLOBE F-7351, SCREW DOWN CHECK ANGLE F-7352

SIZE	15	20	25	32	40	50	65	80	100	125
FF	100	110	120	140	160	210	250	280	340	410
CF	55	60	65	80	85	100	115	130	150	170
D	80	85	95	115	120	130	155	180	200	235
BC	60	65	75	90	95	105	130	145	165	200
wt(kg)	2	3	4	5	6.5	12	17	25	38	52

16K JIS (Japanese) GLOBE F-7303, ANGLE F-7304
SCREW DOWN CHECK GLOBE F-7409, SCREW DOWN CHECK ANGLE F-7410

SIZE	15	20	25	32	40
FF	110	120	130	160	180
CF	70	75	85	95	100
D	95	100	125	135	140
BC	70	75	90	100	105
wt(kg)	3	4	5	7	9

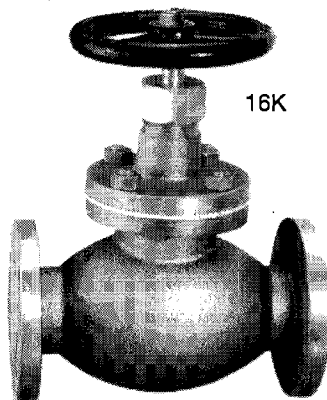

16K

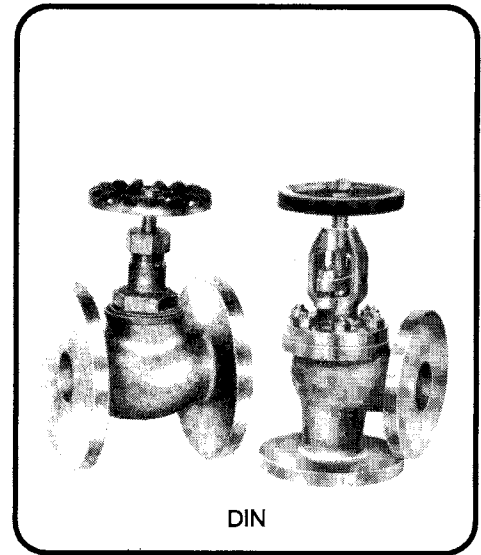

DIN

PN 16	Globe U.B.	993302
PN 16	Angle U.B.	993402
PN 10/16	Globe B.B.	993303
PN 10/16	Angle B.B.	993403

* Add "SDNR" suffix for screw down, non return stop check

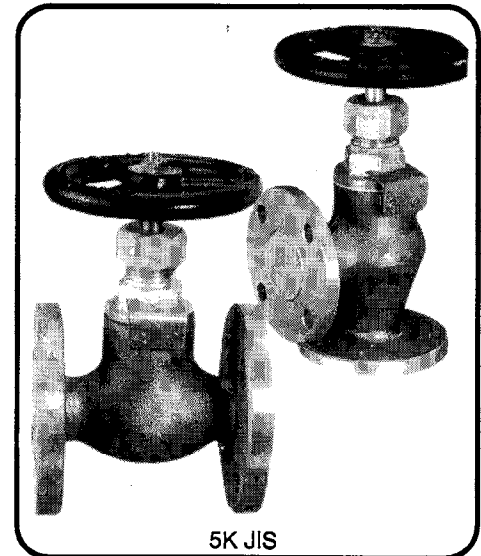
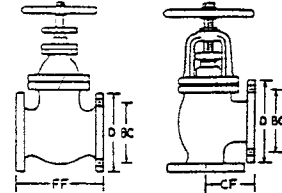

5K JIS

5K Globe	941303
5K Angle	941403
16K Globe	943303
16K Angle	943403

* Add "SDC" suffix for screw down check stop check

BRONZE HOSE GLOBE & ANGLE 150 - 300 LB

FLANGED x HOSE THREAD

UNION BONNET (1-1/2"), BOLTED BONNET (2-1/2")

SIZES: 1-1/2" & 2-1/2"

DESIGN DESCRIPTION

Bronze globe and angle hose valves are supplied with rising stem, bolted or union bonnet, and flanged ends. These valves have resilient discs. 150 LB and 300 LB flanges conform to ANSI B16.24.

Note: When ordering specify type and number of threads per inch. See hose thread dimensions below.

PARTS AND MATERIAL LIST

PART	MATERIAL	SPECIFICATION
body	bronze	B-62
bonnet	bronze	B-62
bonnet gasket	non-asbestos	commercial
stem*	bronze*	B-62
disc	bronze	B-62
disc locknut	bronze	B-62
gland	bronze	B-62
packing	non-asbestos	commercial
hose cap gasket	rubber	commercial
hose cap	bronze	B-62

*available with Monel stem

DIMENSIONS (Inches)

SIZE	1 1/2 (150)	1 1/2 (300)	2 1/2 (150)	2 1/2 (300)
D	5	6 1/8	7	7 1/2
BC	3 7/8	4 1/2	5 1/2	5 7/8
Holes	4	4	4	8
wt	15	23	37	52
Threads per inch (TPI):				
NH	9	9	7 1/2	7 1/2
NPSH	11 1/2	11 1/2	9	9

NH (National Hose) = NST (National Standard Thread)

NPSH (National Pipe Standard Hose) = SIPT (Straight Iron Pipe Thread)

FOR MORE THREAD DIMENSIONS SEE PAGE 79
FOR OTHER HOSE VALVES SEE PAGE 79

PRESSURE / TEMPERATURE RATINGS

200 psi wsp
400 psi wog

550° F
150° F

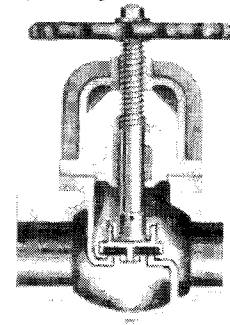

Hose Globe

150 lb x NH 055303
150 lb x NPSH 055301

300 lb x NH 056303
300 lb x NPSH 056301

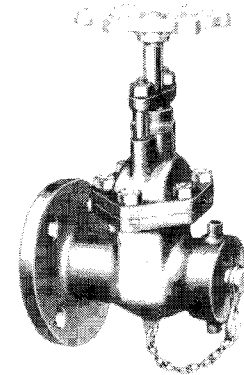

Hose Gate

150 LB x NH 055103
150 LB x NPSH 055101

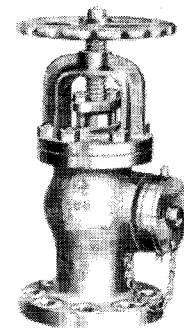

Hose Angle

150 lb x NH 055403
150 lb x NPSH 055401

300 lb x NH 056403
300 lb x NPSH 056401

METRIC HOSE VALVES

SIZES: 15mm to 65mm

Bronze Construction
JIS and DIN style
Straight and Angle

JIS STYLE

Size	KG	Fig Diam	PCD	Holes	Hose Thread	End Type
15	5	80	60	4	M42 x 2	Hose Thread Cap
	10	95	70	4	M42 x 2	Hose Thread Cap
25	5	95	75	4	M42 x 2	Hose Thread Cap
	10	125	90	4	M42 x 2	Hose Thread Cap
40	5	120	95	4	M52 x 2	Nakajima Coupling
	10	140	105	4	M52 x 2	Nakajima Coupling
50	5	130	105	4	M64 x 2	Nakajima Coupling
	10	155	120	4	M64 x 2	Nakajima Coupling
65	10	175	140	4	M80 x 2	Nakajima Coupling

DIN STYLE

Size	Fig Diam	PCD	Holes	End Type
40	150	110	4	Storz Coupling
50	165	125	4	Storz Coupling
65	185	145	4	Storz Coupling

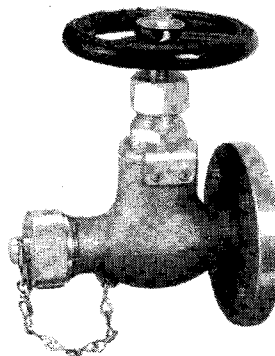

Hose Globe
5K - 941333
10K - 942333

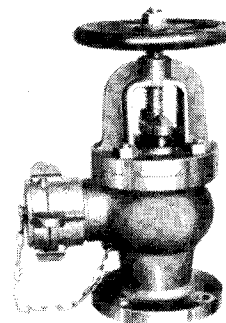

Hose Angle
5K - 941433
10K - 942433

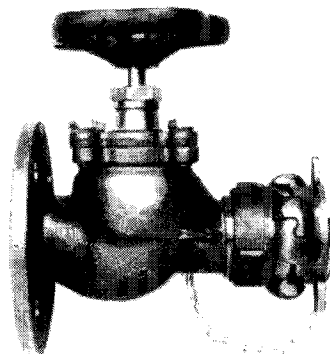

Hose Globe
PN 10/16 - 993333

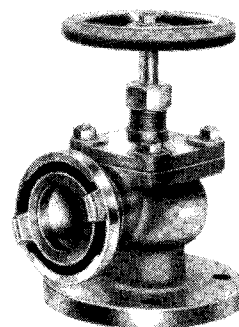

Hose Angle
PN 10/16 - 993433

HOSE FITTINGS



Nakajima
Cap



JIS Metric
Thread Cap

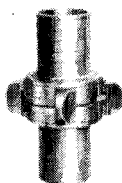

Nakajima
Coupling "F"

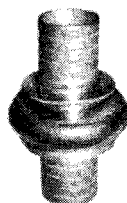

JIS B
Coupling



Storz
Coupling



Female or Male
Thread Storz
Adapter

BRONZE SWING CHECK 150 LB FLGD

SIZES: 1/2" to 14"

DESIGN DESCRIPTION

Threaded cap (1/2" to 2")
 Bolted cap (2" to 14")
 Bronze trim
 Monel trim available

PARTS AND MATERIAL LIST:

PART	MATERIAL	SPECIFICATION
Body	bronze	B-62
Cap	bronze	B-62
Disc*	bronze*	B-62
Disc nut	brass	B-16
Gasket	non-asbestos	commercial
Hinge	bronze	B-62
Hinge pin	brass	B-16
Side plug	bronze	B-62

* available in Monel

DIMENSIONS: Screwed Cap

Size	1/2	3/4	1	1 1/4	1 1/2	2
FF*	3 1/2	4 5/8	5 1/8	5 5/8	6 1/8	7 3/8
D	3 1/2	3 7/8	4 1/4	4 5/8	5	6
BC	2 3/8	2 3/4	3 1/8	3 1/2	3 7/8	4 3/4
wt	3	4	5	7	9	15

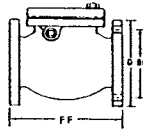

DIMENSIONS: Bolted Cap

Size	2	2 1/2	3	3 1/2	4	5	6	8	10	12	14
FF*	7 3/8	8 3/4	8 1/2	10 1/2	11 1/4	13	14	19 1/2	24 1/2	27 1/2	31
D	6	7	7 1/2	8 1/2	9	10	11	13 1/2	16	19	21
BC	4 3/4	5 1/2	6	7	7 1/2	8 1/2	9 1/2	11 3/4	14 1/4	17	18 3/4
wt	18	31	39	55	67	102	130	280	400	600	820

*Note: face to face dimensions vary by manufacturer

PRESSURE / TEMPERATURE RATINGS

150 psi wsp 550° F
 225 psi wog 150° F

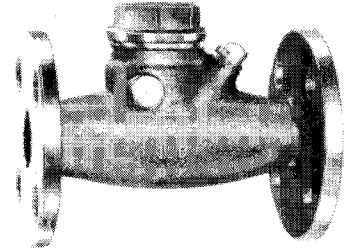

Swing Check Thd Cap
 052503 Bronze Trim
 052504 Monel Trim

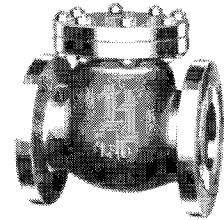

Lift Check Bolted Cap
 052603

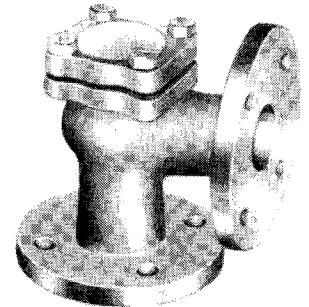

Angle Check
 052703

METRIC BRONZE CHECKS

FLANGED ENDS OR WAFER TYPE

DIN or JIS SPECIFICATIONS

SIZES: 15mm to 250mm

5K JIS (Japanese) SWING CHECK F-7371

SIZE	25	32	40
FF	110	130	140
D	95	115	120
BC	75	90	95
wt(kg)	2	3	4

5K JIS (Japanese) LIFT CK F-7356, F-7415; ANGLE CK F-7416

SIZE	15	20	25	32	40
FF	55	60	120	140	160
D	100	110	95	115	120
BC	60	65	75	90	95
wt(kg)	2	2	3	4	5

PN 10/16 DIN (European) LIFT CHECK

SIZE	15	20	25	32	40	50	65	80	100
FF	70	80	90	105	120	140	180	200	230
D	95	105	115	140	150	165	185	200	220
BC	65	75	85	100	110	125	145	160	180
wt(kg)	2	2	2	4	5	7	10	13	19

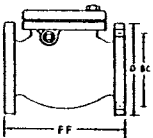

PN 10/16 DIN (European) WAFER CHECK

This thin wafer valve is designed to fit between two joining flanges. The outside diameter of the valve is dimensioned to fit inside the bolts of the joining flanges.

SIZE	40	50	65	80	100	125	150	200	250
Thickness	16	16	16	16	16	18	19	29	29
Diameter	94	109	129	144	164	195	221	276	330
Bore	19	30	38	48	73	96	116	143	190

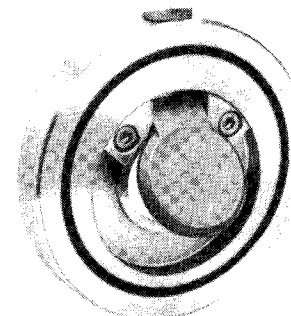
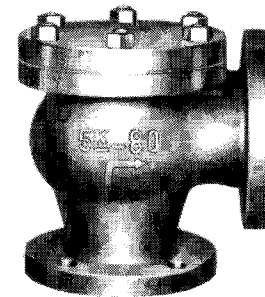
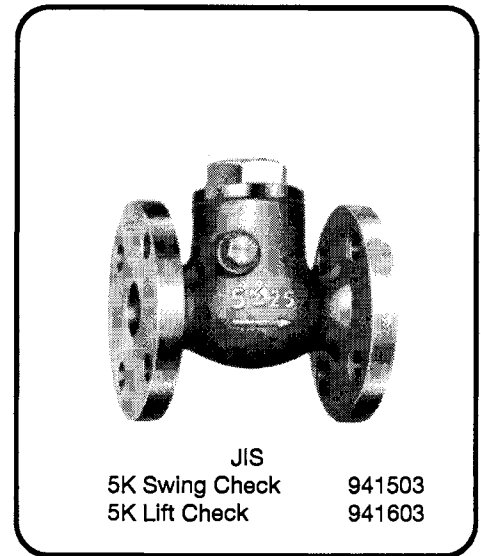

W & O SUPPLY INC

CAST IRON GATE

125 LB

FLANGED ENDS OR THREADED ENDS

SIZES: 2" to 30" FLANGED
1/4" to 6" THREADED

DESIGN DESCRIPTION

OSY Rising Stem or NRS
Bronze-mounted or All-Iron trim
Guided tapered discs

Cast Iron (also called grey iron) gate valves are designed to permit repacking under pressure when fully opened. Threaded end valves conform to ANSI B2.1. Flanged end valves conform to ANSI B16.10 face-to-face dimensions and ANSI B16.1 flange drilling. Recommended for service on steam and non-shock water, oil or gas. Non-rising stem valves available with open/shut indicator.

PRESSURE / TEMPERATURE RATINGS
125 psi wsp 450° F
200 psi wog 150° F

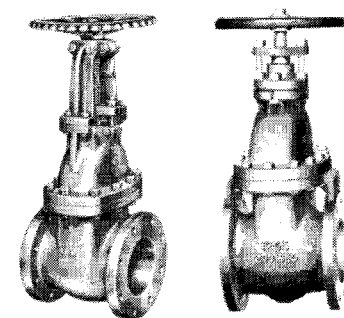

OSY
021103 IBBM
041101 All-Iron

NRS
021203 IBBM

PARTS AND MATERIAL LIST:

PART	MATERIAL	SPECIFICATION
body	cast iron	A-126
bonnet	cast iron	A-126
bonnet gasket	non-asbestos	commercial
stem	bronze	A-124
disc	bronze	B-62
gland	cast iron	A-126
follower gland	brass	B-16
packing	non-asbestos	commercial
backseat bushing	brass	B-16
stem collar	brass	B-16
seat ring	bronze	B-62
yoke bushing	bronze	B-62

"All-Iron" valves have steel stems, iron discs and integral seats.

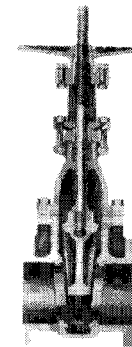

OSY
Cutaway

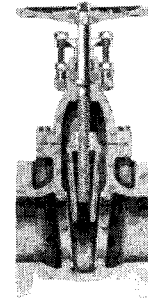

NRS
Cutaway



Clip Gate
IBBM / All Iron
041100

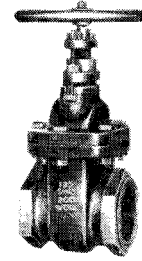

IBBM
Threaded
020103-OSY
020203-NRS

DIMENSIONS (Inches)

SIZE	2	2 1/2	3	3 1/2	4	5	6	8	10	12	14	16	18	20	24	30
FF	7	7 1/2	8	8 1/2	9	10	10 1/2	11 1/2	13	14	15	16	17	18	20	24
D	6	7	7 1/2	8 1/2	9	10	11	13 1/2	16	19	21	23 1/2	25	27 1/2	32	38 3/4
BC	4 3/4	5 1/2	6	7	7 1/2	8 1/2	9 1/2	11 3/4	14 1/4	17	18 3/4	21 1/4	22 3/4	25	29 1/2	36
wt	OSY 42	55	70	95	115	160	200	320	520	700	970	1300	1650	2200	3300	4800
	NRS 40	50	65	90	110	145	170	300	480	650	880	1250	1500	1900	2900	4200

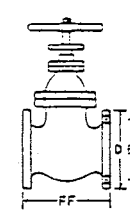

Note: Face to face dimensions vary for U-Clip Gate Valves.

METRIC CAST IRON GATE

FLANGED ENDS

DIN or JIS SPECIFICATIONS

SIZES: 40 mm to 500 mm

Cast Iron body with bronze trim
Ductile (Nodular) Iron body add "DI" to figure number



DIN
PN 6 961203
PN 10/16 962203

DIMENSIONS (millimeters) PN 6 DIN (European)

SIZE	40	50	65	80	100	125	150	200	250	300	350	400	450	500
FF	140	150	170	180	190	200	210	230	250	270	290	310	330	350
D	130	140	160	190	210	240	265	320	375	440	490	540	595	645
BC	100	110	130	150	170	200	225	280	335	395	445	495	550	600
wt(kg)	9	10	14	19	25	40	59	97	138	163	230	295	385	520

PN 10/16 DIN (European)

SIZE	40	50	65	80	100	125	150	175	200	250	300	350	400	450	500
FF	140	150	170	180	190	200	210	220	230	250	270	290	310	330	350
D 10/16	150	165	185	200	220	250	285	315	340	395/405	445/460	505/520	565/580	615/640	670/715
BC10/16	110	125	145	160	180	210	240	270	295	350/355	400/410	460/470	515/525	565/585	620/650
wt(kg)	9	10	14	19	25	40	59	80	97	138	163	230	295	385	520

5K JIS (Japanese) F-7363

SIZE	50	65	80	100	125	150	200	250	300	350	400	450	500
FF	180	190	200	230	250	270	290	330	370	410	470	500	550
D	130	155	180	200	235	265	320	385	430	480	540	605	655
BC	105	130	145	165	200	230	280	345	390	435	495	555	605
wt(kg))	14	19	24	35	48	65	103	164	236	307	405	581	725

10K JIS (Japanese) F-7364

SIZE	50	65	80	100	125	150	200	250	300	350	400	450	500
FF	200	220	230	250	270	290	320	380	440	500	590	640	710
D	155	175	185	210	250	280	330	400	445	490	560	620	675
BC	120	140	150	175	210	240	290	355	400	445	510	565	620
wt(kg)	19	28	33	46	66	86	136	230	331	433	597	704	901

16K JIS (Japanese) F-7369

SIZE	50	65	80	100	125	150	200	250	300	350	400
FF	210	240	260	290	310	330	370	430	490	540	610
D	155	175	200	225	270	305	350	430	480	540	605
BC	120	140	160	185	225	260	305	380	430	480	540
wt(kg)	20	28	36	50	71	93	150	249	403	573	782

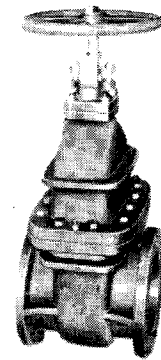
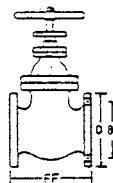

JIS
5K 921103
10K 922103
16K 923103

CAST IRON GLOBE & ANGLE 125 LB

FLANGED or THREADED ENDS

SIZES: 2" to 12" FLANGED ENDS
1/4" to 4" THREADED ENDS

DESIGN DESCRIPTION

Bolted Bonnet
Rising Stem
Renewable Seat and Disc
Bronze-mounted or All-Iron trim
Stop-check available

Cast iron globe and angle valves are designed to permit repacking under pressure when fully open. Bronze-mounted valves are recommended for steam and water service. All-Iron valves are designed for handling fluids which corrode bronze, but not iron, and are not recommended for steam, water or oil service. Flanged ends conform to ANSI B16.10 face-to-face dimensions. Flange drilling conforms to ANSI B16.1.

PARTS AND MATERIAL LIST:

PART	MATERIAL	SPECIFICATION
body	cast iron	A-126
bonnet	cast iron	A-126
bonnet gasket	non-asbestos	commercial
yoke bushing	bronze	B-62
gland follower	cast iron	A-126
packing gland	brass	B-16
packing	non-asbestos	commercial
stem	bronze	A-124
disc	bronze	B-62
seat ring	bronze	B-62

"All-Iron" valves have steel stem, iron disc, integral seat.

DIMENSIONS (Inches)

SIZE	2	2 1/2	3	3 1/2	4	5	6	8	10	12
FF	8	8 1/2	9 1/2	10 1/2	11 1/2	13	14	19 1/2	24 1/2	27 1/2
CF	4	4 1/4	4 3/4	5 1/4	5 3/4	6 1/2	7	9 3/4	12 1/4	13 3/4
D	6	7	7 1/2	8 1/2	9	10	11	13 1/2	16	19
BC	4 3/4	5 1/2	6	7	7 1/2	8 1/2	9 1/2	11 3/4	14 1/4	17
wt	33	52	65	86	103	139	187	346	624	870

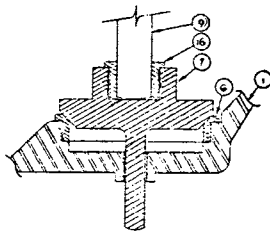
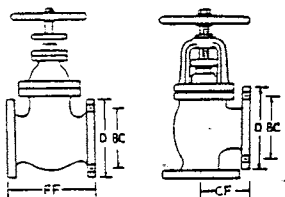

Stop Check Detail

PRESSURE / TEMPERATURE RATINGS

125 psi wsp 450° F
200 psi wog 150° F

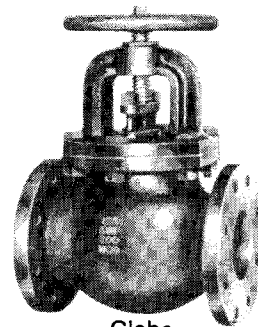

Globe
021303 IBBM
041301 All-Iron

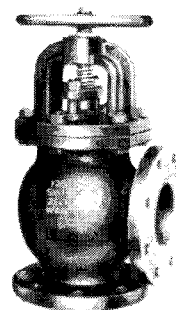

Angle
021403 IBBM

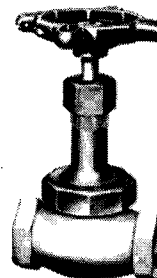

Threaded
Globe 020303
Angle 020403

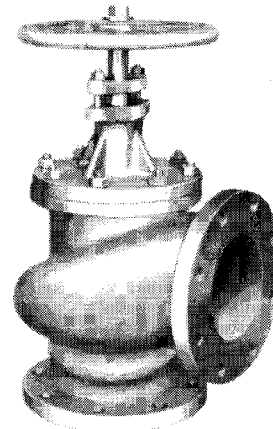

Hi-Lift Cargo Angle
021403-HL

METRIC CAST IRON GLOBE & ANGLE

FLANGED ENDS

DIN or JIS SPECIFICATIONS

SIZES: 15 mm to 550 mm

Cast Iron Body or Nodular (Ductile) Iron
Bronze Trim

PN 6 DIN (European) GLOBE, ANGLE & NON RETURN

SIZE	15	20	25	32	40	50	65	80	100	125	150	200	250	300
FF	130	150	160	180	200	230	290	310	350	400	480	600	730	850
CF	90	95	100	105	115	125	145	155	175	200	225	275	325	375
D	80	90	100	120	130	140	160	190	210	240	265	320	375	440
BC	55	65	75	90	100	110	130	150	170	200	225	280	335	395
wt(kg)	4	4	6	8	10	13	21	26	41	60	83	136	217	325

PN 10/16 DIN (European) GLOBE, ANGLE & NON RETURN

SIZE	15	20	25	32	40	50	65	80	100	125	150	200	250	300
FF	130	150	160	180	200	230	290	310	350	400	480	550	600	730
CF	90	95	100	105	115	125	145	155	175	200	225	250	275	325
D 10/16	95	105	115	140	150	165	185	200	220	250	285	340	395/405	445/460
BC 10/16	65	75	85	100	110	125	145	160	180	210	240	295	350/355	400/410
wt(kg)	4	5	6	8	11	13	21	26	41	60	83	136	217	325

5K JIS (Japanese) GLOBE F-7305, ANGLE F-7306, SCREW DOWN CHECK GLOBE F-7353, SCREW DOWN CHECK ANGLE F-7354

SIZE	50	65	80	100	125	150	200	250	300
FF Globe	210	250	280	340	410	480	570	740	840
CF Angle	100	115	130	150	170	190	220	275	310
D	130	155	180	200	235	265	320	385	430
BC	105	130	145	165	200	230	280	345	390
wt(kg)	15	21	28	41	58	80	139	216	346

10K JIS (Japanese) GLOBE F-7307, ANGLE F-7308, SCREW DOWN CHECK GLOBE F-7375, SCREW DOWN CHECK ANGLE F-7376

SIZE	50	65	80	100	125	150	200	250	300
FF	220	270	300	350	420	490	570	740	840
CF	120	130	140	160	180	205	230	290	320
D	155	175	185	210	250	280	330	400	445
BC	120	140	150	175	210	240	290	355	400
wt(kg)	20	29	32	49	73	104	462	304	458

16K JIS (Japanese) GLOBE F-7309, ANGLE F-7310 SCREW DOWN CHECK GLOBE F-7377, SCREW DOWN CHECK ANGLE F-7378

SIZE	50	65	80	100	125	150	200	250	300
FF	220	270	300	350	430	500	570	760	860
CF	120	130	150	170	200	225	250	310	340
D	155	175	200	225	270	305	350	430	480
BC	120	140	160	185	225	260	305	380	430
wt(kg)	18	25	35	49	76	103	155	257	380

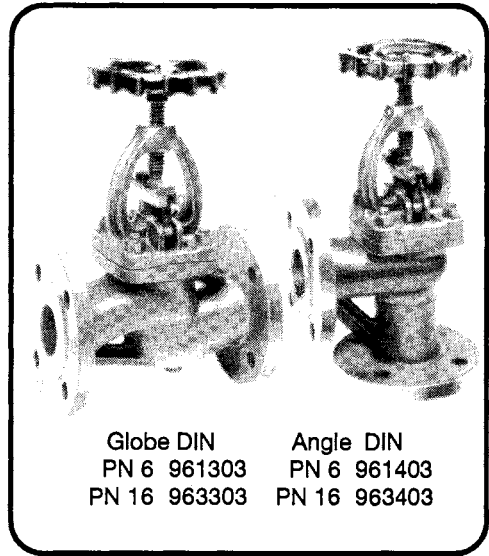

Globe DIN PN 6 961303
Angle DIN PN 6 961403
PN 16 963303 PN 16 963403

Globe Ductile Iron 973303
Angle Ductile Iron 973403

Add "SDNR" Suffix for Screw Down Non-Return Stop Check

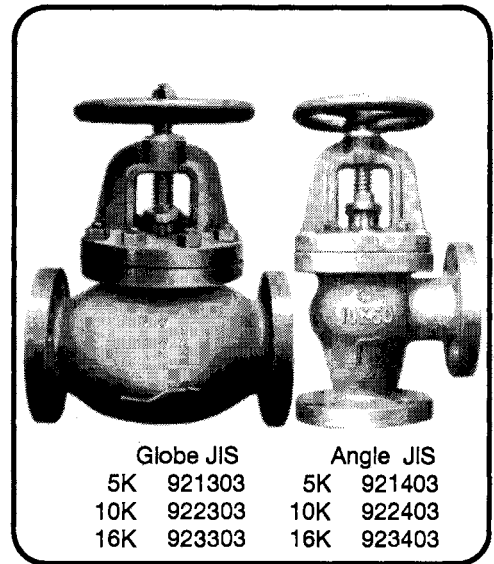
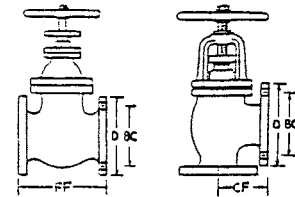

Globe JIS 5K 921303
Angle JIS 5K 921403
10K 922303 10K 922403
16K 923303 16K 923403

Add "SDC" Suffix for Screw Down Check Stop Check

CAST IRON SWING CHECK 125 LB

FLANGED or THREADED ENDS

SIZES: 2" to 24"

DESIGN DESCRIPTION

Bolted cap
Bronze-mounted or All-Iron trim
Available with lever and weight

Valve disc is hinged to swing entirely clear of the waterway when fully open and to seat with gravity. Flanged valves conform to ANSI B16.10 face-to-face dimensions. Flanges are drilled to ANSI B16.1.

PARTS AND MATERIAL LIST:

PART	MATERIAL	SPECIFICATION
body	cast iron	A-126
bonnet cap	cast iron	A-126
bonnet gasket	non-asbestos	commercial
hanger pin	brass	B-16
hanger	bronze	B-62
seat ring	cast bronze	B-62
disc	bronze	B-62
disc nut	brass	B-16

"All-Iron" valves have iron disc and integral seat.

DIMENSIONS (Inches)

SIZE	2	2 1/2	3	3 1/2	4	5	6	8	10	12	14	16	18	20
FF	8	8 1/2	9 1/2	10 1/2	11 1/2	13	14	19 1/2	24 1/2	27 1/2	31	30	33	36
D	6	7	7 1/2	8 1/2	9	10	11	13 1/2	16	19	21	23 1/2	25	27 1/2
BC	43/4	5 1/2	6	7	7 1/2	8 1/2	9 1/2	11 3/4	14 1/4	17	18 3/4	21 1/4	22 3/4	25
wt	22	37	44	57	71	104	139	258	423	649	900	1260	1580	1912

TILTING DISC CHECK 125 & 250 LB

FLANGED ENDS

SIZES: 2" to 54"

Bronze Trim

Disc resists slamming because it is partially balanced and has a short travel distance from full open to full close. When high reverse pressure head and pressure surge are anticipated, valves can be equipped with a special disc restraining dashpot to control closure.

Disc is designed with an "aerofoil" configuration, with pivots located above the center of the disc, to reduce pressure drop. See cutaway page 33.

Face to face dimensions vary by manufacturer.

PRESSURE / TEMPERATURE RATINGS

125 psi wsp
200 psi wog

450° F
150° F

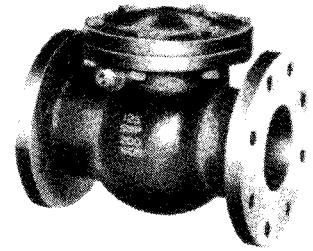

021503 IBBM
041501 All-Iron

Lever & Weight
021533

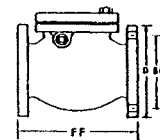

PRESSURE / TEMPERATURE RATINGS

125 psi wsp

450° F

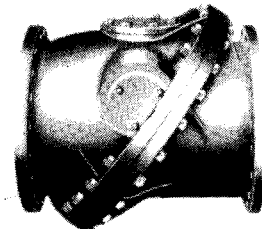

021903

METRIC CAST IRON CHECK VALVES

FLANGED ENDS

DIN or JIS SPECIFICATIONS

SIZES: 40mm to 500mm

Cast Iron body with bronze trim
Ductile (Nodular) Iron body add "DI" to figure number

PN 10/16 DIN (European) SWING CHECK

SIZE	40	50	65	80	100	125	150	200	250	300
FF	180	200	230	260	300	350	400	500	600	700
D	150	165	185	200	220	250	285	340	395	445
BC	110	125	145	160	180	210	240	295	350	400
wt(kg)	10	12	17	22	28	42	54	86	160	210

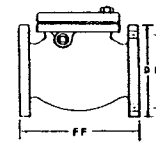

PN 10/16 DIN (European) LIFT CHECK

SIZE	15	20	25	32	40	50	65	80	100	125	150	200
FF	130	150	160	180	200	230	290	310	350	400	480	600
D	95	105	115	140	150	165	180	200	220	250	285	340
BC	65	75	85	100	110	125	145	165	180	210	240	295
wt(kg)	2	3	4	6	7	10	15	20	31	49	69	132

5K JIS (Japanese) SWING CHECK F-7372

SIZE	50	65	80	100	125	150	200	250
FF	190	220	250	280	330	380	460	550
D	130	155	180	200	235	265	320	385
BC	105	130	145	165	200	230	280	345
wt(kg)	9	14	19	27	39	54	94	150

10K JIS (Japanese) SWING CHECK F-7373

SIZE	50	65	80	100	125	150	200
FF	21	240	270	300	350	400	480
D	155	175	185	210	250	280	330
BC	120	140	150	175	210	240	290
wt(kg)	14	20	23	31	49	65	103

5K JIS (Japanese) LIFT CHECK F-7358

SIZE	50	65	80	100	125	150
FF	210	250	280	340	410	480
D	130	155	180	200	235	265
BC	105	130	145	165	200	230
wt(kg)	11	17	23	33	48	68

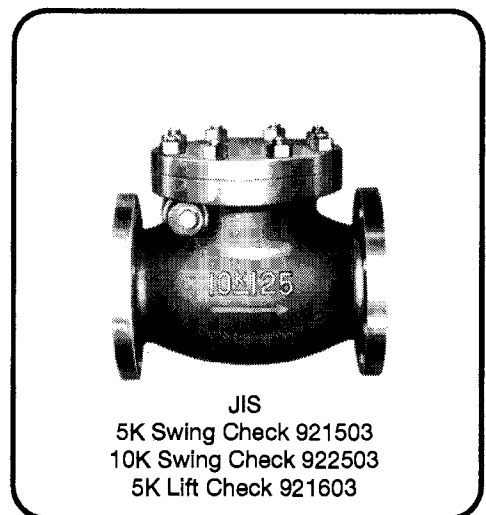
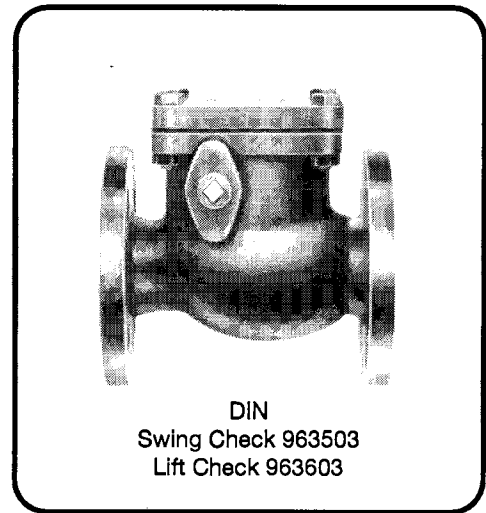

DUCTILE / NODULAR IRON GATE 150 LB

FLANGED ENDS

SIZES: 2" to 24"

DESIGN DESCRIPTION

OSY Rising Stem or NRS
Bronze Trim
Threaded Seat Rings
For Metric Sizes see page 26

Cast ductile iron, also called nodular iron or spheroidal iron, is less brittle than cast grey iron. It has malleability similar to steel and corrosion resistance like that of grey iron. Ductile iron to ASTM A-395 is often approved for installation in shipboard applications where steel valves are indicated for use. Ductile iron gate valves are designed to permit repacking under pressure when fully opened. Flange dimensions conform to ANSI B16.5. Face-to-face dimensions conform to ANSI B16.10.

PRESSURE / TEMPERATURE RATINGS

165 psi wsp
275 psi wog

450° F
100° F

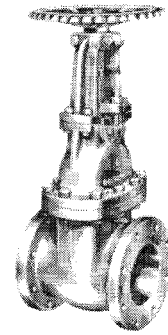

OSY
032103

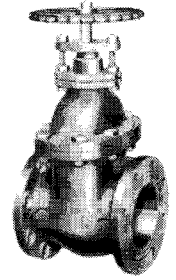

NRS
032203

PARTS AND MATERIAL LIST:

PART	MATERIAL	SPECIFICATION
body	ductile iron	A-395
bonnet	ductile iron	A-395
bonnet gasket	non-asbestos	commercial
stem	brass	B-124
disc	bronze	B-61
disc nut	brass rod	B-16
gland	malleable iron	A-197
packing	non-asbestos	commercial
stuffing box	ductile iron	A395
stuffing box gasket	non-asbestos	commercial
stem bushing (NRS)	bronze	B-61
seat ring	bronze	B-61

Also available with monel stem, disc, seat

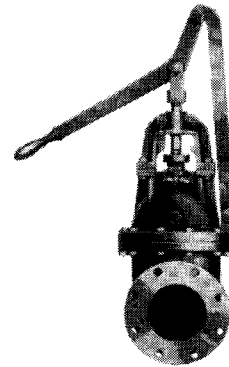

Quick Open

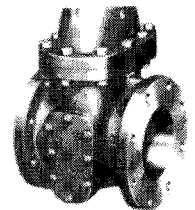

Cleanout

DIMENSIONS (Inches)

SIZE	2	2 1/2	3	3 1/2	4	5	6	8	10	12	14	16	18	20	24
FF	7	7 1/2	8	8 1/2	9	10	10 1/2	11 1/2	13	14	15	16	17	18	20
D	6	7	7 1/2	8 1/2	9	10	11	13 1/2	16	19	21	23 1/2	25	27 1/2	32
BC	4 3/4	5 1/2	6	7	7 1/2	8 1/2	9 1/2	11 3/4	14 1/4	17	18 3/4	21 1/4	22 3/4	25	39 1/2
wt OSY	42	55	70	95	115	160	200	320	520	700	970	1300	1650	2200	3300
wt NRS	40	50	65	90	110	145	170	300	480	650	880	1250	1500	1900	2900

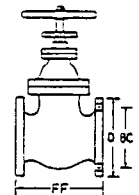

DUCTILE IRON GLOBE & ANGLE 150 LB

FLANGED ENDS

SIZES: 2" to 16"

DESIGN DESCRIPTION

Bolted Bonnet
OSY Rising Stem
Bronze Trim
Monel Trim and Stop-check available
Metric Sizes see page 28

Cast ductile iron, also called nodular iron or spheroidal iron, is less brittle than cast grey iron. It has malleability similar to steel and has corrosion resistance like that of grey iron. Ductile iron to ASTM A-395 is often approved for installation in shipboard applications where steel valves are indicated for use. Ductile iron valves are designed to permit repacking under pressure when fully open. Flange dimensions conform to ANSI B16.5. Face-to-face dimensions conform to ANSI B16.10. Recommended for throttling service.

PARTS AND MATERIAL LIST:

PART	MATERIAL	SPECIFICATION
body	ductile iron	A-395
bonnet	ductile iron	A-395
bonnet gasket	non-asbestos	commercial
bonnet bushing	bronze	B-62
stem*	brass	B-124
disc*	bronze	B-62
disc locknut	bronze	B-62
gland	malleable iron	A-197
packing	non-asbestos	commercial
seat ring	bronze	B-62

*Also available with monel stem, disc, seat

PRESSURE / TEMPERATURE RATINGS

165 psi wsp
275 psi wog

450° F
150° F

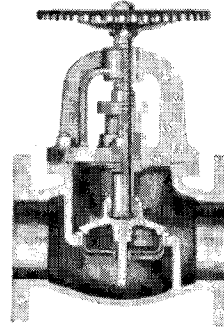

Globe
032303

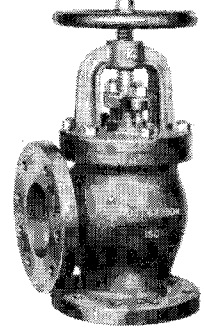

Angle
032403

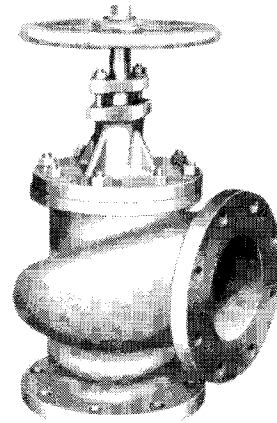

High Lift Cargo Angle

DIMENSIONS (Inches)

SIZE	2	2 1/2	3	3 1/2	4	5	6	8	10	12	14	16
FF	8	8 1/2	9 1/2	10 1/2	11 1/2	13	14	19 1/2	24 1/2	27 1/2	31	36
CF	4	4 1/4	4 3/4	5 1/4	5 3/4	6 1/2	7	9 3/4	12 1/4	13 3/4	15 1/2	18
D	6	7	7 1/2	8 1/2	9	10	11	13 1/2	16	19	21	23 1/2
BC	4 3/4	5 1/2	6	7	7 1/2	8 1/2	9 1/2	11 3/4	14 1/4	17	18 3/4	21 1/4
wt	30	40	53	65	87	119	151	379	624	830	1000	1200

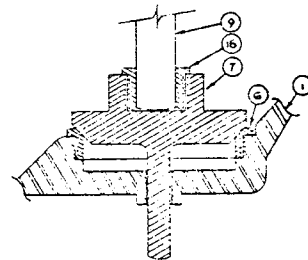

Stop Check

* Add "SC" suffix to Fig. No.

DUCTILE IRON SWING CHECK 150 LB

FLANGED ENDS

SIZES: 2" to 16"

DESIGN DESCRIPTION

Bolted Cap
Bronze Trim
Monel Trim available

Cast ductile iron, also called nodular iron or spheroidal iron is less brittle than cast grey iron. It has malleability similar to steel and corrosion resistance like that of grey iron. Ductile iron to ASTM A-395 is often approved for installation in shipboard applications where steel valves are indicated for use. Ductile iron check valve discs are hinged to swing entirely clear of the waterway when fully opened. Flange dimensions conform to ANSI B16.5. Face-to-face dimensions conform to ANSI B16.10.

PARTS AND MATERIAL LIST

PART	MATERIAL	SPECIFICATION
hanger pin	brass rod	B-16
hanger	steel	A-216
disc nut	steel	commercial
cover gasket	non-asbestos	commercial
cover	ductile iron	A-395
body	ductile iron	A-395
seat ring*	bronze	B-62
disc*	bronze	B-62
side plug	brass	B 140

*Monel disc and seat available

DIMENSIONS (Inches)

SIZE	2	2 1/2	3	3 1/2	4	5	6	8	10	12	14	16
FF	8	8 1/2	9 1/2	9 1/2	11 1/2	13	14	19 1/2	24 1/2	27 1/2	31	30
BC	4 3/4	5 1/2	6	7	7 1/2	8 1/2	9 1/2	11 3/4	14 1/4	17	18 3/4	21 1/4
D	6	7	7 1/2	8 1/2	9	10	11	13 1/2	16	19	21	23 1/2
wt	25	42	48	65	89	113	146	291	485	649	900	1260

TILTING DISC CHECK 150 LB

FLANGED ENDS

SIZES: 2" to 54"

Disc resists slamming because it is partially balanced and has a short travel distance from full open to full close. When high reverse pressure head and pressure surge are anticipated, valves can be equipped with a special disc restraining dashpot to control closure.

Disc is designed with an "aerofoil" configuration, with pivots located above the center of the disc, to reduce pressure drop.

Face to face dimensions vary by manufacturer.

W & O SUPPLY INC

PRESSURE / TEMPERATURE RATINGS

165 psi wsp 450° F
275 psi wog 150° F

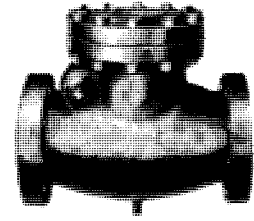

032503

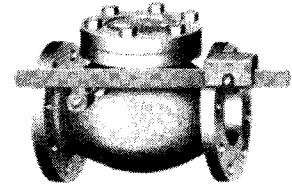

Lever Weight
032533

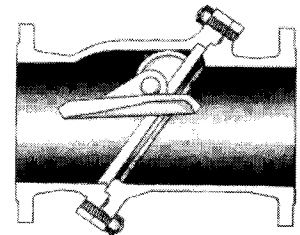
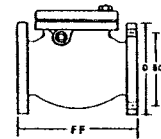

032903

LOW PRESSURE DOUBLE DISC GATE (LIST 581/2)

FLANGED ENDS

SIZES: 10" to 72"

RISING STEM (OS&Y) or NON RISING STEM (NRS)

DESIGN DESCRIPTION

List 581/2 valve bodies are available in ductile iron, cast iron, cast steel, or bronze. Valves can be supplied all iron, or with bronze or monel trim. Discs are available in double-disc, solid-disc or roller type parallel slide disc configurations. Flange dimensions conform to 25 psi American Standard B16.2-31.

These valves are suitable for service in low pressure water, steam, gas and air lines, in exhaust or condenser piping, in water works, in sewage and irrigation systems, in pumping stations, in drydock systems and aboard ship.

Available with handwheel, angle bevel gear or motor operator.

To order please specify:

- OSY or NRS
- Body and trim material
- Double disc or taper solid wedge
- Face to face, bolt circle & number of holes
- Operator type

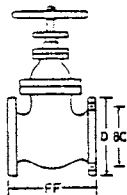

DIMENSIONS (Inches)

SIZE	10	12	14	16	18	20	22	24	26	28	30	32	34	36	38	40	42	46	48	54
FF*	10 1/2	11	11 1/2	12	12 1/2	13	13	13 1/4	13 1/2	14	15	15	15	16	16	17	17 1/2	18	19 1/2	21
D	16	19	21	23 1/2	25	27 1/2	29 1/2	32	34 1/4	36 1/2	38 3/4	41 3/4	43 3/4	46	48 3/4	50 3/4	53	57 1/4	59 1/2	66 1/4
BC	14 1/2	17	18 3/4	21 1/4	22 3/4	25	27 1/4	29 1/2	31 3/4	34	36	38 1/2	40 1/2	42 3/4	45 1/4	47 1/4	49 1/2	53 3/4	56	62 3/4
Holes	12	12	12	16	16	20	20	20	24	28	28	28	32	32	32	36	36	40	44	44
wt	280	390	540	680	880	1090	1200	1570	1800	2200	2780	3300	3700	4070	4700	5500	6500	8000	9200	12000

*Note: Face to face dimensions vary by manufacturer

PRESSURE / TEMPERATURE RATINGS

10" - 30" 25 psi wsp 50 psi wog
36" - 72" 25 psi wsp 35 psi wog

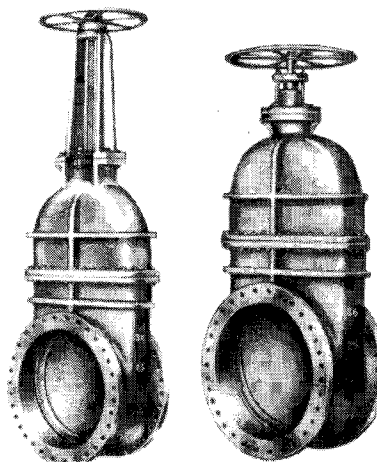

OSY

NRS

Cast Iron Bronze Trim

OSY 021143

NRS 021243

Cast Iron Monel Trim

OSY 021144

NRS 021244

Ductile Iron Bronze Trim

OSY 032143

NRS 032243

Ductile Iron Monel Trim

OSY 032144

NRS 032244

Bronze Body Bronze Trim

OSY 052143

NRS 052243

Bronze Body Monel Trim

OSY 052144

NRS 052244

IRON GATE, GLOBE, ANGLE & CHECK 250 LB

FLANGED ENDS

SIZES: 2" to 12"

DESIGN DESCRIPTION

Bolted Bonnet
OSY Rising Stem or NRS
Bronze Trim

SIZE	2	2 1/2	3	4	5	6	8	10	12
FF Gate	8 1/2	9 1/2	11 1/8	12	15	15 7/8	16 1/2	18	19 3/4
FF Globe & Check	10 1/2	11 1/2	12 1/2	14	15 3/4	17 1/2	21	24 1/2	27 1/2
CF Angle	5 1/4	5 3/4	6 1/4	7	7 7/8	8 3/4	10 1/2	12 1/4	13 3/4
D	6 1/2	7 1/2	8 1/4	10	11	12 1/2	15	17 1/2	20 1/2
BC	5	5 7/8	6 5/8	7 7/8	9 1/4	10 5/8	13	15 1/4	17 3/4

BOILER NON-RETURN GLOBE & ANGLE 250 LB

FLANGED ENDS

SIZES: 2-1/2" to 10"

DESIGN DESCRIPTION

Cast Iron Body (A-126 class B)
Bronze Trim
These valves comply with Section 1 of ASME Boiler and pressure vessel code.

Dimensions same as 250 LB iron valves above.

NI-RESIST & 3% NI-IRON GATE & CHECK

FLANGED ENDS

SIZES: 2" to 24"

DESIGN DESCRIPTION

Ni-resist body (20% nickel A-436 type 2) or
3% Nickel Body (A-126 Class B Mod)
Stainless Steel Trim
OSY Rising Stem (gate)
Bolted Bonnet

Dimensions same as IBBM valves on page 25 & 29

PRESSURE / TEMPERATURE RATINGS

250 psi wsp 450° F
500 psi wog 150° F

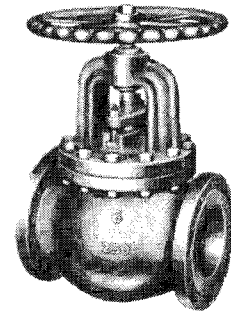

Gate OSY 023103 Globe 023303
Gate NRS 023203 Angle 023503
Check 023503

PRESSURE / TEMPERATURE RATINGS

250 psi wsp 450° F
500 psi wsp 150° F

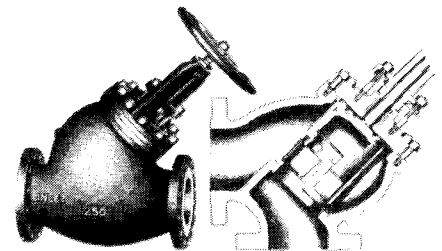

Globe Angle
023803 023903

PRESSURE / TEMPERATURE RATINGS

200 (12") 150° F
150 (20") 150° F

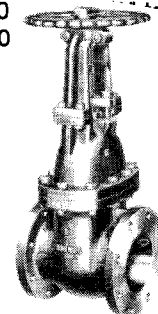

NI-RESIST 3% NICKEL IRON
Gate 044101 Gate 045101
Check 044501 Check 045501

CAST STEEL GATE

NRS 150 LB

FLANGED ENDS

SIZES: 2" to 24"

DESIGN DESCRIPTION

Non-rising Stem
 Bolted Bonnet
 Solid Disc
 Bronze Trim or CR13/HF trim
 Monel trim available
 Available with indicator

PARTS AND MATERIAL LIST:

DESCRIPTION	MATERIAL	SPECIFICATION
Body	carbon steel	A-216 WCB
Bonnet	carbon steel	A-216 WCB
*Bonnet Gasket	non-asbestos	Commercial
Stem Bushing	ductile iron	A-439 Type D2
Gland Flange	steel	A-216 WCB
*Packing	non-asbestos	Commercial
CR 13/HF Trim:		
Stem	13% Chrome stainless	Type 416
Disc	13% Chrome stainless	Type 416
Seat Rings	HF Stellite faced	A159
Gland	13% Chrome stainless	Type 416
Bronze Trim:		
Stem	brass	B124
Disc	bronze	B62
Seat Rings	bronze faced steel	B62
Gland	bronze	B62

*Available with John Crane 1065 Packing

DIMENSIONS (Inches)

SIZE	2	2 1/2	3	3 1/2	4	5	6	8	10
FF	7	7 1/2	8	8 1/2	9	10	10 1/2	11 1/2	13
D	6	7	7 1/2	8 1/2	9	10	11	13 1/2	16
BC	4 3/4	5 1/2	6	7	7 1/2	8 1/2	9 1/2	11 3/4	14 1/4
wt	38	60	73	91	110	145	189	297	462

SIZE	12	14	16	18	20	24
FF	14	15	16	17	18	20
D	19	21	23 1/2	25	27 1/2	32
BC	17	18 3/4	21 1/4	22 3/4	25	29 1/2
wt	682	869	1195	1490	1840	2200

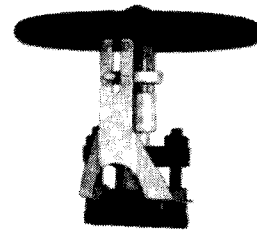
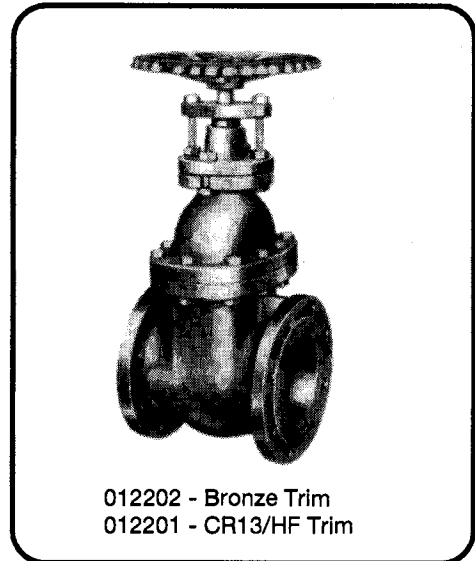
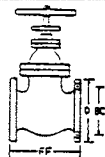

Indicator

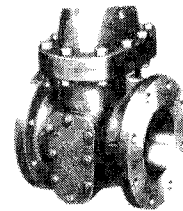

Clean out option

CAST STEEL GATE

OS & Y 150 LB

FLANGED ENDS

SIZES: 2" to 36"

DESIGN DESCRIPTION

Outside Screw & Yoke
 Rising Stem
 Bolted Bonnet
 CR13 Trim with HF Seats or Bronze Trim
 Monel, 316 SS and Full Stellite Trim available
 Butt weld Ends available
 Available in C5 material for high temperature

PARTS AND MATERIAL LIST:

DESCRIPTION	MATERIAL	SPECIFICATION
Body	carbon steel	A-216 WCB
Bonnet	carbon steel	A-216 WCB
Bonnet Gasket	non-asbestos	Commercial
Stem Bushing	ductile iron	A-439 Type D2
Gland Flange	steel	A-216 WCB
Packing	non-asbestos	Commercial
CR13/HF Trim:		
Stem	13% Chrome stainless	Type 416
Disc	13% Chrome stainless	Type 416
Seat Rings	HF Stellite faced	A159
Gland	13% Chrome stainless	Type 416
Bronze Trim:		
Stem	brass	B124
Disc	bronze	B62
Seat Rings	bronze faced steel	B62
Gland	bronze	B62

DIMENSIONS (Inches)

SIZE	2	2 1/2	3	3 1/2	4	5	6	8	10	12
FF F.E.	7	7 1/2	8	8 1/2	9	10	10 1/2	11 1/2	13	14
FF BWE	8 1/2	9 1/2	11 1/8	8 1/2	12	15	15 7/8	16 1/2	18	19 3/4
D	6	7	7 1/2	8 1/2	9	10	11	13 1/2	16	19
BC	4 3/4	5 1/2	6	7	7 1/2	8 1/2	9 1/2	11 3/4	14 1/4	17
wt	52	72	90	115	140	150	240	380	585	770

SIZE	14	16	18	20	24	30	36
FF F.E.	15	16	17	18	20	30	*
FF BWE	22 1/2	24	26	28	32	*	*
D	21	23 1/2	25	27 1/2	32	38 3/4	46
BC	18 3/4	21 1/4	22 3/4	25	29 1/2	36	42 3/4
wt	1085	1380	1810	2200	3315	5050	8100

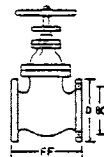

* Dimension varies by manufacturer

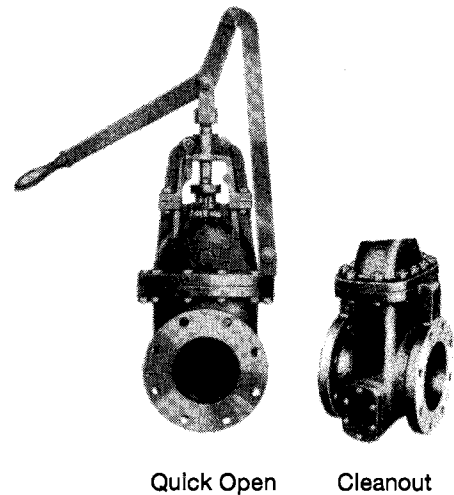
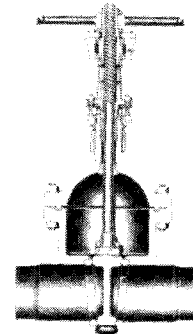
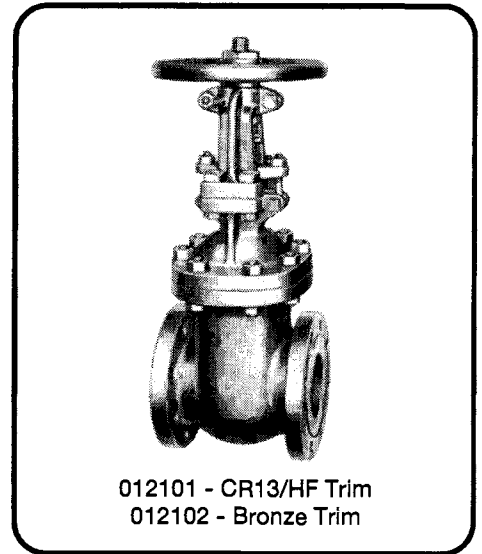

METRIC CAST STEEL GATE

FLANGED ENDS

DIN or JIS SPECIFICATIONS

SIZES: 40 mm to 500 mm

Cast Steel Body
Available With Bronze or Stainless Trim
Non-Rising or Rising Stem

DIMENSIONS (millimeters)

PN 10 DIN (European)

SIZE	40	50	65	80	100	125	150	200	250	300	350	400
FF	140	150	170	180	190	200	210	230	250	270	290	310
D	150	165	185	200	220	250	285	340	395	445	505	565
BC	110	125	145	160	180	210	240	295	350	400	460	515
wt(kg)	13	16	19	24	31	40	49	73	111	140	190	240

PN 16 DIN (European) Long Pattern

SIZE	40	50	65	80	100	125	150	200	250	300	350	400
FF	240	250	270	280	300	325	350	400	450	500	550	600
D	150	165	185	200	220	250	285	340	405	460	520	580
BC	110	125	145	160	180	210	240	295	355	410	470	525
wt(kg)	24	25	35	38	49	57	86	146	230	314	438	590

10K JIS (Japanese) F-7366

SIZE	50	65	80	100	125	150	200	250	300	350	400
FF	200	220	230	250	270	290	310	340	380	420	480
D	155	175	185	210	250	280	330	400	445	490	560
BC	120	140	150	175	210	240	290	355	400	445	510
wt(kg)	17	27	32	45	63	82	130	203	291	368	507

16K JIS (Japanese)

SIZE	50	65	80	100	125	150	200	250	300	350	400
FF	210	240	260	290	310	330	370	430	490	540	610
D	155	175	200	225	270	305	350	430	480	540	605
BC	120	140	160	185	225	260	305	380	430	480	540
wt(kg)	20	28	36	50	71	93	150	249	403	573	782

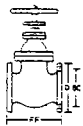

DIN PN 10 952203
PN 16 953201

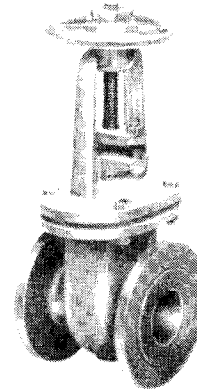

OSY
DIN PN 10 952101

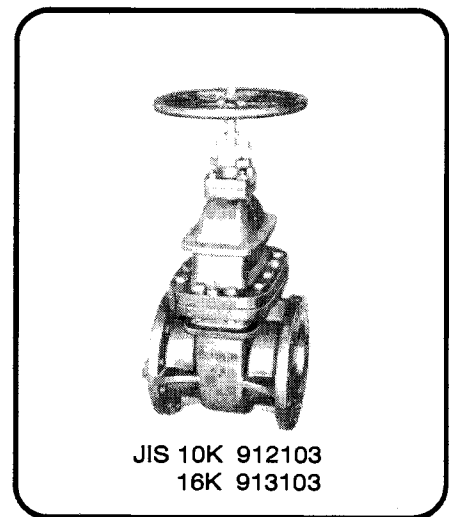

JIS 10K 912103
16K 913103

CAST STEEL GATE

300 - 600 - 900 - 1500 LB

FLANGED ENDS

SIZES: 2" to 24"

DESIGN DESCRIPTION

Carbon steel body and bonnet A216 WCB
 Bolted Bonnet
 Outside Screw & Yoke
 Rising Stem
 CR13 Trim with HF Seats
 Full Stellite Trim available
 Buttweid or RTJ Flanged Ends available
 Also available in WC6, WC9, or C5 material for high temperature

DIMENSIONS (Inches)

300 LB

SIZE	2	2 1/2	3	3 1/2	4	5	6	8	10	12	14
FF	8 1/2	9 1/2	11 1/8	11 7/8	12	15	15 7/8	16 1/2	18	19 3/4	30
D	6 1/2	7 1/2	8 1/4	9	10	11	12 1/2	15	17 1/2	20 1/2	23
BC	5	5 7/8	6 5/8	7 1/4	7 7/8	9 1/4	10 5/8	13	15 1/4	17	20 1/4
wt	66	80	112	150	171	235	340	540	790	1120	1720

400 LB

SIZE	2	2 1/2	3	3 1/2	4	5	6	8	10	12	14
FF					16	18	19 1/2	23 1/2	26 1/2	30	32 1/8
D		see 600 LB			10	11	12 1/2	15	17 1/2	20 1/2	23
BC					7 7/8	9 1/4	10 5/8	13	15 1/4	17 3/4	20 1/4
wt					295	370	520	895	1400	1830	2500

600 LB

SIZE	2	2 1/2	3	3 1/2	4	5	6	8	10	12	14
FF	11 1/2	13	14	15	17	20	22	26	31	33	35
D	6 1/2	7 1/2	8 1/4	9	10 3/4	13	14	16 1/2	20	22	23 3/4
BC	5	5 7/8	6 5/8	7 1/4	8 1/2	10 1/2	11 1/2	13 3/4	17	19 1/4	20 3/4
wt	97	132	176	250	320	520	680	1150	1715	2440	3310

900 LB

SIZE	2	2 1/2	3	3 1/2	4	5	6	8	10	12	14
FF			15	17	18	22	24	29	33	38	40 1/2
D	see 1500 LB		9 1/2	10 3/4	11 1/2	13 3/4	15	18 1/2	21 1/2	24	25 1/4
BC			7 1/2	8 1/2	9 1/4	11	12 1/2	15 1/2	18 1/2	21	22
wt			255	350	440	700	905	1610	2425	3620	5120

1500 LB

SIZE	2	2 1/2	3	4	5	6	8	10	12
FF	14 1/2	16 1/2	18 1/2	21 1/2	26 1/2	27 3/4	32 3/4	39	44 1/2
D	8 1/2	9 5/8	10 1/2	12 1/4	14 3/4	15 1/2	19	23	26 1/2
BC	6 1/2	7 1/2	8	9 1/2	11 1/2	12 1/2	15 1/2	19	22 1/2
wt	205	295	375	615	1100	1450	2670	4450	7250

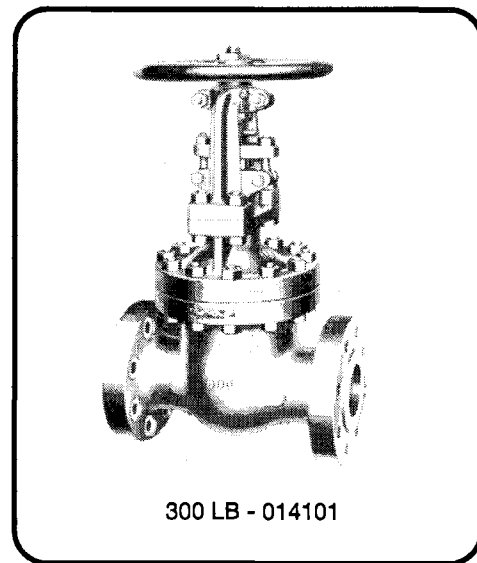

300 LB - 014101

- 400 LB - 015101
- 600 LB - 016101
- 900 LB - 017101
- 1500 LB - 019101

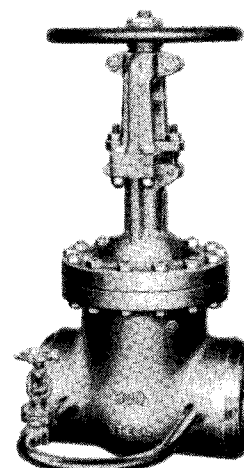

Buttweid Ends*

- 300 LB - 004101
- 600 LB - 006101
- 900 LB - 007101
- 1500 LB - 008101
- 2500 LB - 009101

*Equalizer (shown) add "EQ"

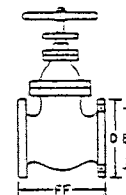

CAST STEEL GLOBE & ANGLE 150 LB

FLANGED ENDS

SIZES: 2" to 20"

DESIGN DESCRIPTION

Bolted Bonnet
 OSY Rising Stem
 CR13 Trim with HF Seats or Bronze Trim
 Monel, 316 SS and Full Stellite Trim available
 Stop-Check (Non-Return) available
 Butt-weld Ends available
 Available in C5 material for high temperature

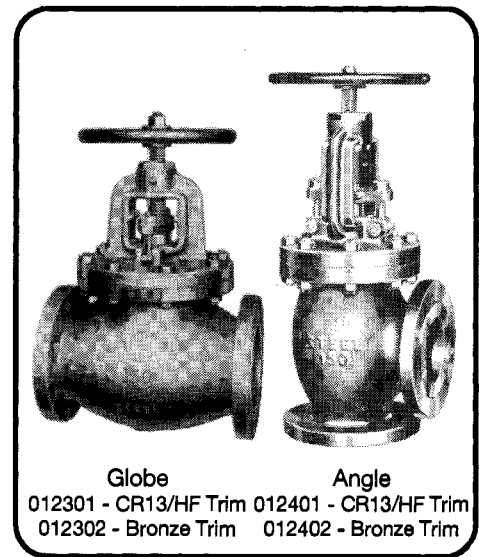

Globe Angle
 012301 - CR13/HF Trim 012401 - CR13/HF Trim
 012302 - Bronze Trim 012402 - Bronze Trim

PARTS AND MATERIAL LIST:

DESCRIPTION	MATERIAL	SPECIFICATION
Body	carbon steel	A-216
Bonnet	steel	A-216
Gland Flange	steel	A-216
Packing	non-asbestos	Commercial
Bonnet Gasket	non-asbestos	Commercial
Yoke Nut	ductile iron	A-439 type D2
CR13/HF Trim:		
Stem	13% Chrome stainless	Type 416
Disc	13% Chrome stainless	Type 416
Disc Nut	13% Chrome stainless	Type 416
Seat Rings	HF Stellite faced	A159
Gland	13% Chrome stainless	Type 416
Bronze Trim:		
Stem	brass	B124
Disc	bronze	B62
Disc Nut	bronze	B62
Seat Rings	bronze faced steel	B62
Gland	bronze	B62

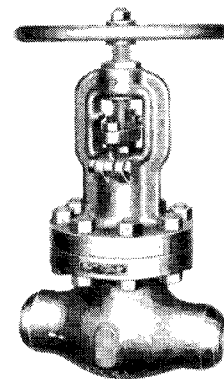

Butt-weld
 002301 - Globe
 002401 - Angle

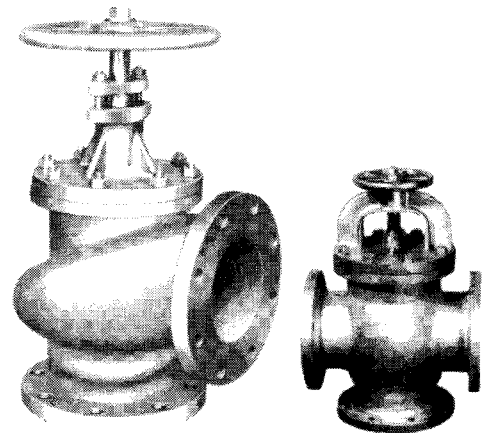

High Lift Angle

Cross Valve

DIMENSIONS (Inches)

SIZE	2	2 1/2	3	3 1/2	4	5	6	8	10	12
FF	8	8 1/2	9 1/2	10 1/2	11 1/2	14	16	19 1/2	24 1/2	27 1/2
CF	4	4 1/4	4 3/4	5 1/4	5 3/4	7	8	9 3/4	12 1/4	13 3/4
D	6	7	7 1/2	8 1/2	9	10	11	13 1/2	16	19
BC	43/4	5 1/2	6	7	7 1/2	8 1/2	9 1/2	11 3/4	14 1/4	17
wt	50	60	80	115	135	180	230	420	700	850

Note: CF Dimension may vary on large angle valves.

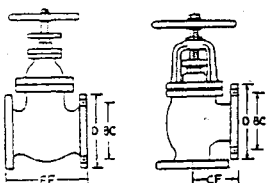

CAST STEEL

GLOBE & ANGLE

300 - 600 - 900 - 1500 LB

SIZES: 2" to 14"

DESIGN DESCRIPTION

Bolted Bonnet
 CR13 Trim with HF Seats
 Bronze, Monel, 316 SS and Full Stellite Trim available
 Stop-Check (Non-Return) available
 Flanged or Buttweild ends
 RTJ ends available
 Available in WC6, WC9 or C5 material for high temperature

300 LB

SIZE	2	2 1/2	3	3 1/2	4	5	6	8	10	12	14
FF	10 1/2	11 1/2	12 1/2	13 1/4	14	15 3/4	17 1/2	22	24 1/2	28	33
CF	5 1/4	5 3/4	6 1/4	6 5/8	7	7 7/8	8 3/4	11	12 1/4	14	16 1/2
D	6 1/2	7 1/2	8 1/4	9	10	11	12 1/2	15	17 1/2	20 1/2	23
BC	5	5 7/8	6 5/8	7 1/4	7 7/8	9 1/4	10 5/8	13	15 1/4	17 3/4	20 1/4
wt	83	110	135	180	220	280	390	740	1010	1675	2240

400 LB

SIZE	2	2 1/2	3	3 1/2	4	5	6	8
FF					16	18	19 1/2	23 1/2
CF					8	9	9 3/4	11 3/4
D		see 600 LB			10	11	12 1/2	15
BC					7 7/8	9 1/4	10 5/8	13
wt					255	340	460	860

600 LB

SIZE	2	2 1/2	3	3 1/2	4	5	6	8	10	12	14
FF	11 1/2	13	14	15	17	20	22	26	31	33	35
CF	5 3/4	6 1/2	7	7 1/2	8 1/2	10	11	13	15 1/2	16 1/2	17 1/2
D	6 1/2	7 1/2	8 1/4	10	10 3/4	13	14	16 1/2	20	22	23 3/4
BC	5	5 7/8	6 5/8	7 7/8	8 1/2	10 1/2	11 1/2	13 3/4	17	19 1/4	20 3/4
wt	91	142	176	260	315	490	700	1310	1900	2450	3080

900 LB

SIZE	2	2 1/2	3	3 1/2	4	5	6	8	10	12
FF			15	17	18	22	24	29	33	38
CF	2" and 2 1/2"		7 1/2	8 1/2	9	11	12	14 1/2	16 1/2	19
D	see 1500 LB		9 1/2	10 3/4	11 1/2	13 3/4	15	18 1/2	21 1/2	24
BC			7 1/2	8 1/2	9 1/4	11	12 1/2	15 1/2	18 1/2	21
wt			253	380	475	780	1145	1815	3080	5000

1500 LB

SIZE	2	2 1/2	3	4	5	6	8	10
FF	14 1/2	16 1/2	18 1/2	21 1/2	26 1/2	27 3/4	32 3/4	39
CF	7 1/4	8 1/4	9 1/4	10 3/4	13 1/4	13 7/8	16 3/8	19 1/2
D	8 1/2	9 5/8	10 1/2	12 1/4	14 3/4	15 1/2	19	23
BC	6 1/2	7 1/2	8	9 1/2	11 1/2	12 1/2	15 1/2	19
wt	200	255	350	685	805	1300		

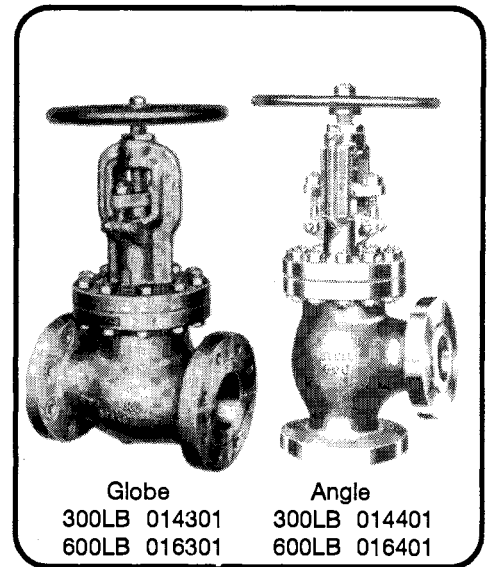

Globe
 300LB 014301
 600LB 016301

Angle
 300LB 014401
 600LB 016401

900LB 017301
 1500LB 019301

900LB 017401
 1500LB 019401

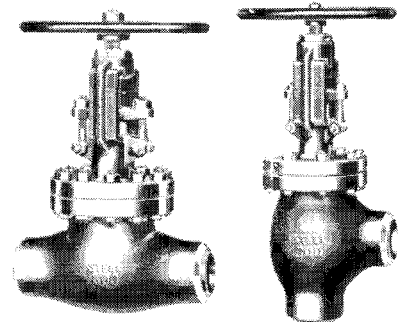

Buttweld Ends
 Globe
 300LB 014301
 600LB 016301
 900LB 017301
 1500LB 019301

Angle
 300LB 014401
 600LB 016401
 900LB 017401
 1500LB 019401

For equalizer add "EQ" see page 39

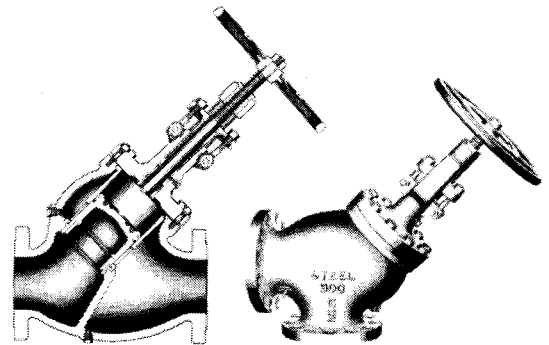

Boiler Non-Return Valves
 Globe
 300LB 014801
 600LB 016801

Angle
 300LB 014901
 600LB 016901

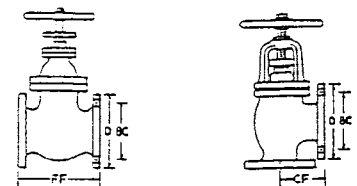

METRIC CAST STEEL GLOBE & ANGLE

FLANGED ENDS

SIZES: 15 mm to 300 mm

Cast Steel Body

Available with Bronze or Stainless Trim

DIMENSIONS (millimeters)

PN 16 DIN (European)

SIZE	15	20	25	32	40	50	65	80	100	125	150	200	250	300
FF	130	150	160	180	200	230	290	310	350	400	480	600	730	850
CF	90	95	100	105	115	125	145	155	175	200	225	275	325	375
D	95	105	115	140	150	165	185	200	220	250	285	340	405	460
BC	65	75	85	100	110	125	145	160	180	210	240	295	355	410
wt(kg)	5	6	7	11	14	19	30	34	49	69	98	180	280	360

PN 40 DIN (European)

SIZE	15	20	25	32	40	50	65	80	100	125	150	200	250	300
FF	130	150	160	180	200	230	290	310	350	400	480	600	730	850
CF	90	95	100	105	115	125	145	155	175	200	225	275	325	375
D	95	105	115	140	150	165	185	200	235	270	300	375	450	515
BC	65	75	85	100	110	125	145	160	190	220	250	320	385	450
wt(kg)	5	6	7	11	14	19	30	34	49	69	98	180	280	360

5K JIS (Japanese) GLOBE F-7311, ANGLE F-7312

SIZE	50	65	80	100	125	150	200	250	300
FF	210	250	280	340	410	480	570	740	840
CF	100	115	130	150	170	190	220	275	310
D	130	155	180	200	235	265	320	385	430
BC	105	130	145	165	200	230	280	345	390
wt(kg)	15	21	28	41	58	80	139	230	309

10K JIS (Japanese) GLOBE F-7319, ANGLE F-7320

SIZE	50	65	80	100	125	150	200	250	300
FF	220	270	300	350	420	490	570	740	840
CF	120	130	140	160	180	205	230	290	320
D	155	175	185	210	250	280	330	400	445
BC	120	140	150	175	210	240	290	335	400
wt(kg)	18	26	30	45	70	96	159	257	370

20K JIS (Japanese) GLOBE F-7421 & F-7313, ANGLE F-7422 & F-7314 SCREW DOWN CHECK GLOBE F-7473, SCREW DOWN CHECK ANGLE F-7474

SIZE	15	20	25	32	40	50	65	80	100	125	150	200
FF	140	160	180	190	200	230	270	300	350	430	500	560
CF	75	80	95	100	110	125	135	150	170	200	225	280
D	95	100	125	135	140	155	175	200	225	270	305	350
BC	70	75	90	100	105	120	140	160	185	225	260	305
wt(kg)	4	5	8	14	16	22	30	44	62	95	132	204

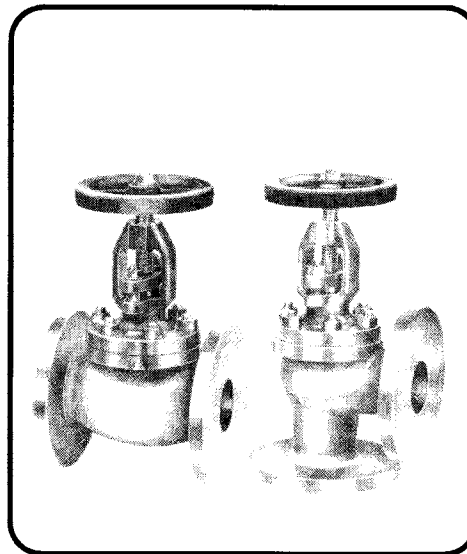

DIN PN 16 Globe 953300
 Angle 953400
DIN PN 40 Globe 953301
 Angle 953401

Add "SNDR" suffix for screw down
non return stop check

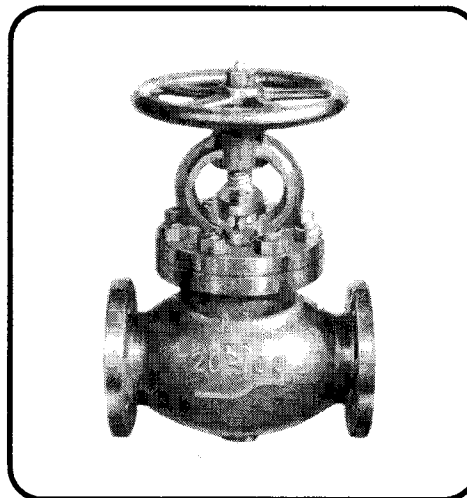
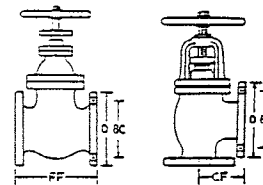

JIS 5K Globe 911303
 Angle 911403
 Check 911503
JIS 10K Globe 912303
 Angle 912403
JIS 20K Globe 914301
 Angle 914401

Add "SDC" suffix for screw down check

ROCKWELL EDWARDS CAST STEEL VALVES 300-600-900-1500 LB

SIZES: 2 1/2" to 20"

DESIGN DESCRIPTION

Cast Carbon (A216 WCB) or Chromemoly (WC6 or WC9) Body
Bolted or Pressure Seal Bonnets
Full Stellite Trim
Buttweld or Flanged Ends
Globe and Angle Valves available as Non-Return Stop Check

Face-to-Face Dimensions and Flanging same as Cast Steel ANSI valves on page 41 & 47. Most BW dims. same as flanged (pg 204).

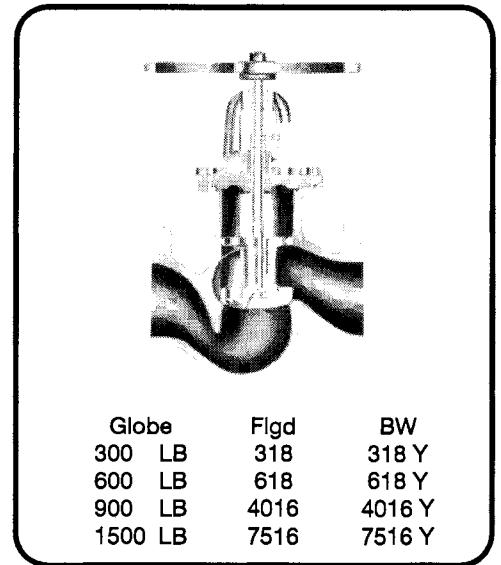

Globe	Flgd	BW
300 LB	318	318 Y
600 LB	618	618 Y
900 LB	4016	4016 Y
1500 LB	7516	7516 Y

Globe Non-Return		
300 LB	302	302 Y
600 LB	604	604 Y
900 LB	4006	4006 Y
1500 LB	7506	7506 Y

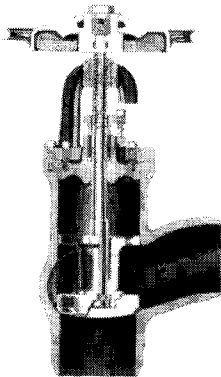

Angle	Flgd	BW
300 LB	319	319 Y
600 LB	617	617 Y
900 LB	4017	4017 Y
1500 LB	7517	7517 Y
Angle Non-Return		
300 LB	303	303 Y
600 LB	605	605 Y
900 LB	4007	4007 Y
1500 LB	7507	7507 Y

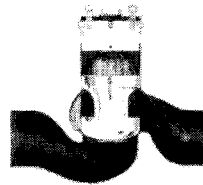

Lift Check	Flgd	BW
300 LB	392	392 Y
600 LB	690	690 Y
900 LB	4094	4094 Y
1500 LB	7594	7594 Y

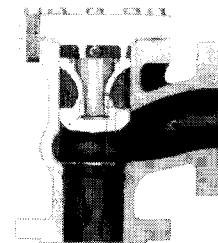

Angle Check	Flgd	BW
300 LB	393	393 Y
600 LB	691	691 Y
900 LB	4095	4095 Y
1500 LB	7595	7595 Y

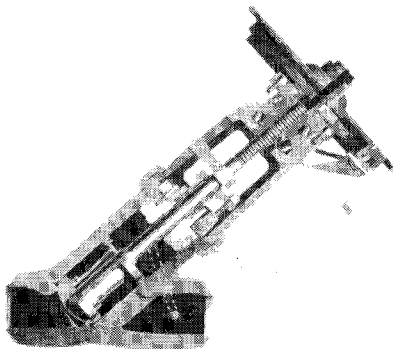

Y Globe	Flgd	BW
600 LB	614	614 Y
1500 LB	7514	7514 Y
Y Globe Non Return		
600 LB	602	602 Y
1500 LB	7502	7502 Y

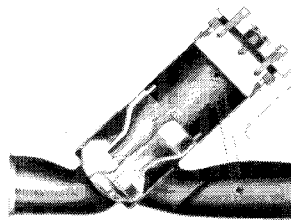

Y Check	Flgd	BW
600 LB	692	692 Y
1500 LB	7592	7592 Y

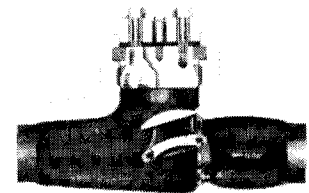

Tilt Disc Check	Flgd	BW
900 LB	970	970 Y
1500 LB	1570	1570 Y

PRESSURE SEAL VALVES

600-900-1500-2500 LB

FLANGED or BUTTWELD ENDS

DESIGN DESCRIPTION

Carbon Steel: WCB (cast), A105 (forged)
 Chromemoly: WC6 (cast), WC9 (cast), F-11 (forged), F-22 (forged)

Pressure seal body-to-bonnet connection is self-energizing and is assembled with a special seal ring. Accomodation is made for initial preload and take-up on the joint by the use of adjustable alloy bolts.

Non-Return feature available, as well as bypass or equalizer lines.
 Replacement seal ring gaskets available.

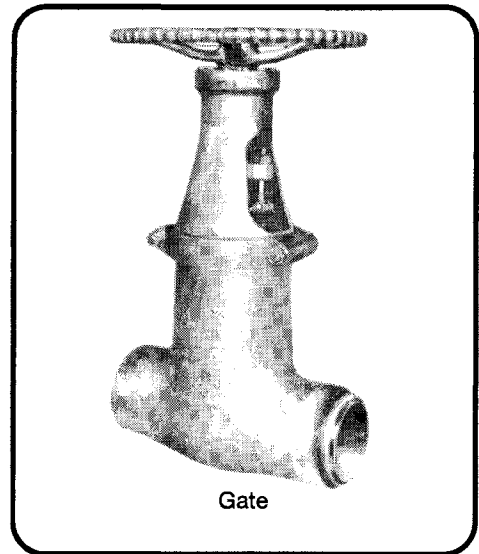

Gate

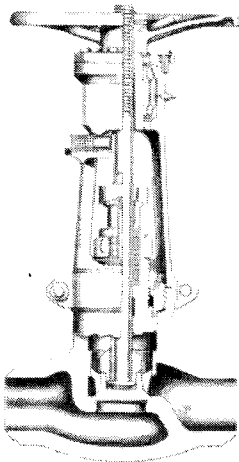

Globe

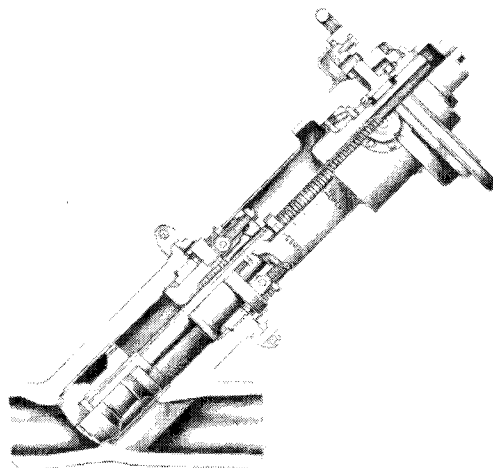

Y-Globe

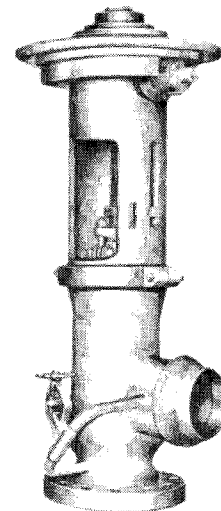

Angle

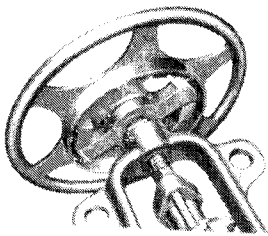

Hammer Blow Impactor Handwheel
 Gives 3-10 times closing force

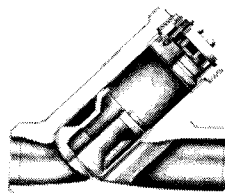

Y-Check

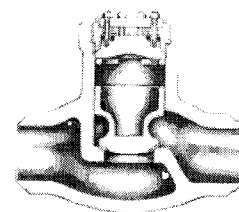

Lift Check

CAST STEEL SWING CHECK 150 LB

FLANGED ENDS

SIZES: 2" to 24"

DESIGN DESCRIPTION

Bolted Cap
CR13 Trim with HF Seats or Bronze Trim
Monel or 316 SS trim available
Buttweld Ends available
Available in C5 material for high temperature

PARTS AND MATERIAL LIST:

DESCRIPTION	MATERIAL	SPECIFICATION
Body	carbon steel	A-216 WCB
Cap	steel	A-216 WCB
Gasket	non-asbestos	commercial
Hanger Arm	steel	A-216 WCB
Plug	stainless steel	Type 416
CR13/HF Trim:		
Disc	13% Chrome stainless	Type 416
Seat Rings	HF Stellite faced	A159
Hinge Pin	13% Chrome stainless	Type 416
Bronze Trim:		
Disc	bronze	B62
Seat Rings	bronze faced steel	B62
Hinge Pin	bronze	B124

DIMENSIONS (Inches)

SIZE	2	2 1/2	3	3 1/2	4	5	6	8	10	12	14	16
FF	8	8 1/2	9 1/2	9 1/2	11 1/2	13	14	19 1/2	24 1/2	27 1/2	31	36
D	6	7	7 1/2	8 1/2	9	10	11	13 1/2	16	19	21	23 1/2
BC	4 3/4	5 1/2	6	7	7 1/2	8 1/2	9 1/2	11 3/4	14 1/4	17	18 3/4	21 1/4
wt	40	48	59	77	95	132	187	330	480	690	860	990

TILTING DISC CHECK 150 LB

SIZES: 2" to 54"

Disc resists slamming because it is partially balanced and has a short travel distance from full open to full close. When high reverse pressure head and pressure surge are anticipated, valves can be equipped with a special disc restraining dashpot to control closure.

Disc is designed with an "aerofoil" configuration, with pivots located above the center of the disc, to reduce pressure drop. See cutaway on page 33.

Face to face dimensions vary by manufacturer.



012502 - Bronze Trim
012501 - CR13/HF Trim

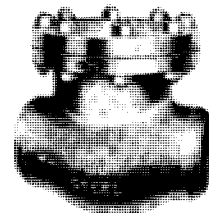

Buttweld Ends
002501

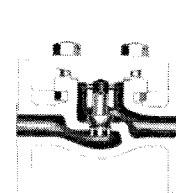

Lift Check
012601

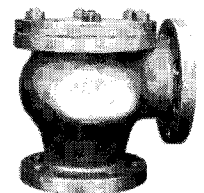

Angle Check
012701

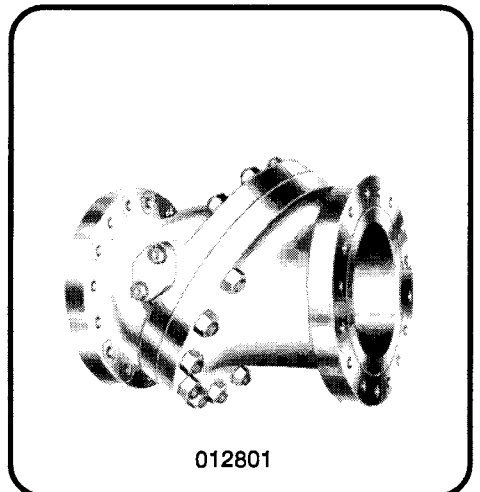

012801

METRIC CAST STEEL CHECK VALVES

FLANGED ENDS

DIN or JIS SPECIFICATIONS

SIZES: 40mm to 500mm

PN 16 DIN (European) SWING CHECK

SIZE	40	50	65	80	100	125	150	200	250
FF	180	200	240	260	300	350	400	500	600
D	150	165	185	200	250	220	285	340	405
BC	110	125	145	160	180	210	240	295	355
wt(kg)	12	16	22	29	41	57	75	120	195

PN 40 DIN (European) LIFT CHECK

SIZE	15	20	25	32	40	50	65	80	100	125	150	200	250	300
FF	130	150	160	180	200	230	290	310	350	400	480	500	730	850
D	95	105	115	140	150	165	185	200	235	270	300	375	450	515
BC	65	75	85	100	110	125	145	160	190	220	250	320	385	450
wt(kg)	4	4	5	8	11	15	25	26	42	56	82	152	230	290

10K JIS (Japanese) SWING CHECK

SIZE	50	65	80	100	125	150	200
FF	210	240	270	300	350	400	480
D	155	175	185	210	250	280	330
BC	120	140	150	175	210	240	290
wt(kg)	14	20	23	31	49	65	103

10K JIS (Japanese) LIFT CHECK

SIZE	50	65	80	100	125	150	200
FF	220	270	300	350	420	490	570
D	155	175	185	210	250	280	330
BC	120	140	150	175	210	240	290
wt(kg)	15	25	30	40	60	80	120

PN 10/16 DIN (European) WAFER SWING CHECK

SIZE	50	65	80	100	125	150	200	250
Thickness	19	19	19	19	19	19	29	29
Diameter	109	129	144	164	195	221	276	330
Bore	26	38	47	70	92	114	143	190

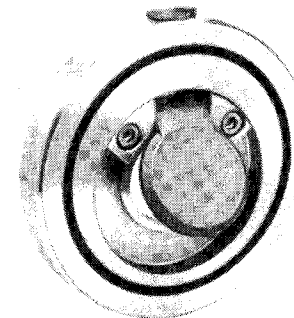
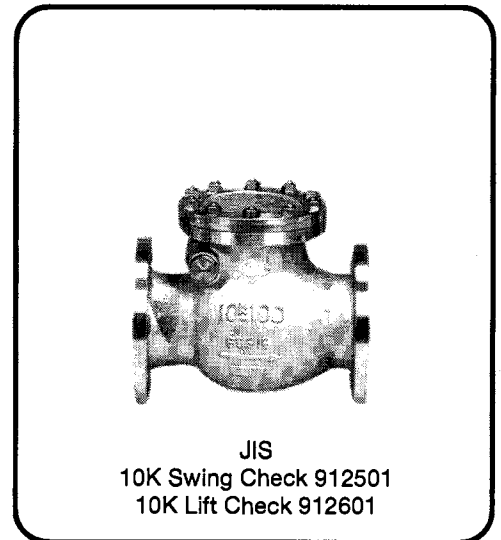
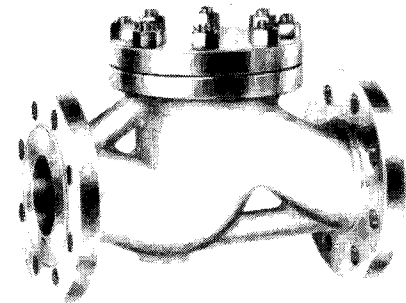
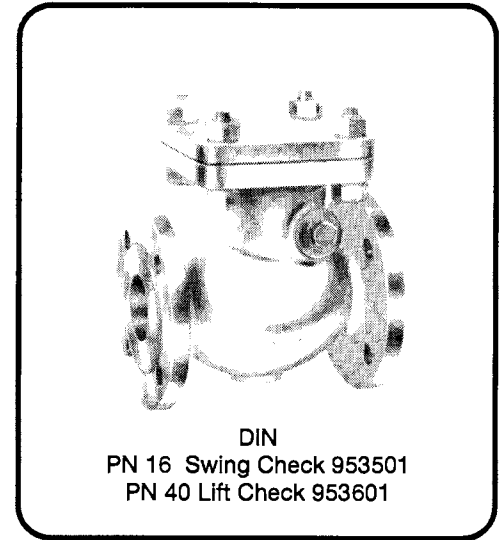
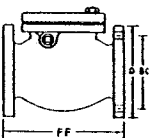

CAST STEEL SWING & LIFT/PISTON CHECK 300-600-900-1500 LB

FLANGED ENDS

SIZES: 2" to 16"

DESIGN DESCRIPTION

Bolted Cap
CR13 Trim with HF Seats
Buttweld and RTJ Flanged Ends available
Available in WC6, WC9 or C5 material for high temperature

DIMENSIONS (Inches)

300 LB

SIZE	2	2 1/2	3	3 1/2	4	5	6	8	10	12	14
FF	10 1/2	11 1/2	12 1/2	13 1/4	14	13	17 1/2	21	24 1/2	28	30
D	6 1/2	7 1/2	8 1/4	9	10	11	12 1/2	15	17 1/2	20 1/2	23
BC	5	5 7/8	6 5/8	7 1/4	7 7/8	9 1/4	10 5/8	13	15 1/4	17 3/4	20 1/4
wt	40	48	59	75	95	140	187	330	480	690	860

600 LB

SIZE	2	2 1/2	3	3 1/2	4	5	6	8	10	12	14
FF	11 1/2	13	14	15	17	20	22	26	31	33	35
D	6 1/2	7 1/2	9	8 1/4	10 3/4	13	14	16 1/2	20	22	23 3/4
BC	5	5 7/8	6 5/8	7 1/4	8 1/2	10 1/2	11 1/2	13 3/4	17	19 1/4	20 3/4
wt	77	101	141	170	235	355	460	860	1290	1730	2190

900 LB

SIZE	2	2 1/2	3	3 1/2	4	5	6	8	10	12
FF			15	17	18	22	24	29	33	38
D	See		9 1/2	10 3/4	11 1/2	13 3/4	15	18 1/2	21 1/2	24
BC	1500 LB		7 1/2	8 1/2	9 1/4	11	12 1/2	15 1/2	18 1/2	21
wt			195	290	350	500	660	1220	1910	3090

1500 LB

SIZE	2	2 1/2	3	4	5	6	8	10	12
FF	14 1/2	16 1/2	18 1/2	21 1/2	26 1/2	27 3/4	32 3/4	39	44 1/2
D	8 1/2	9 5/8	10 1/2	12 1/4	14 3/4	15 1/2	19	23	26 1/2
BC	6 1/2	7 1/2	8	9 1/2	11 1/2	12 1/2	15 1/2	19	22 1/2
wt	185	270	310	575	950	1290	2150	3710	5280

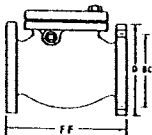

W & O SUPPLY INC

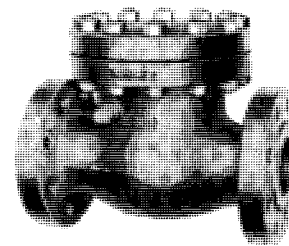

Swing Check

300 LB	014501
600 LB	016501
900 LB	017501
1500 LB	019501

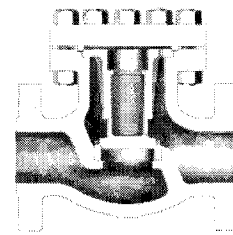

Lift Check / Piston Check

300 LB	014601
600 LB	016601
900 LB	017601
1500 LB	019601

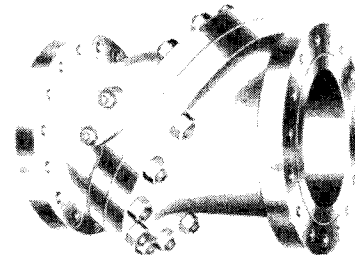

Tilt Disc Check

300 LB	014801
600 LB	016801
900 LB	017801
1500 LB	019801

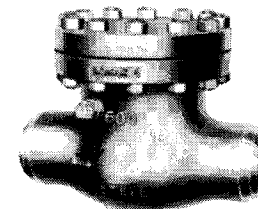

Buttweld

300 LB	Swing	004501
300 LB	Lift/Piston	004601
300 LB	Tilt Disc	004801
600 LB	Swing	006501
600 LB	Lift/Piston	006601
600 LB	Tilt Disc	006801
900 LB	Swing	007501
900 LB	Lift/Piston	007601
1500 LB	Swing	009501
1500 LB	Lift/Piston	009601

FORGED STEEL GATE

150-300-600/800-1500 LB

FLANGED, THREADED or SOCKETWELD ENDS
BOLTED or WELDED BONNET

SIZES: 1/4" to 2"

DESIGN DESCRIPTION

Multi-purpose valve suitable for steam, liquid or gas
Body and Bonnet of Carbon Steel (A-105) or Chromemoly (F11/F22)
CR13 Trim with HF Integral Seats
410 Stainless Steel Disc & Stem
316 SS, Monel or Stellite Disc & Stem available with HF Integral Seat
Available to MIL-V-18110 (page 154)
Metric flanged -please specify drilling standard and face-to-face.

DIMENSIONS (Inches)

150 LB FLANGED

SIZE	1/2	3/4	1	1 1/4	1 1/2	2
FF	4 1/4	4 5/8	5	5 1/2	6 1/2	7
D	3 1/2	3 7/8	4 1/4	4 5/8	5	6
BC	2 3/8	2 3/4	3 1/8	3 1/2	3 7/8	4 3/4
wt	7	11	13	18	22	31

300 LB FLANGED

SIZE	1/2	3/4	1	1 1/4	1 1/2	2
FF	5 1/2	6	6 1/2	7 1/2	7 1/2	8 1/2
D	3 3/4	4 5/8	4 7/8	5 1/4	6 1/8	6 1/2
BC	2 5/8	3 1/4	3 1/2	3 7/8	4 1/2	5
wt	9	12	16	25	30	43

600 LB FLANGED

SIZE	1/2	3/4	1	1 1/4	1 1/2	2
FF	6 1/2	7 1/2	8 1/2	9	9 1/2	11 1/2
D	3 3/4	4 5/8	4 7/8	5 1/4	6 1/8	6 1/2
BC	2 5/8	3 1/4	3 1/2	3 7/8	4 1/2	5
wt	10	12	19	30	38	51

900 / 1500 LB FLANGED

SIZE	1/2	3/4	1	1 1/4	1 1/2	2
FF	8 1/2	9	10	11	12	14 1/2
D	4 3/4	5 1/8	5 7/8	6 1/4	7	8 1/2
BC	3 1/4	3 1/2	4	4 3/8	4 7/8	6 1/2
wt	22	35	55	68	77	99

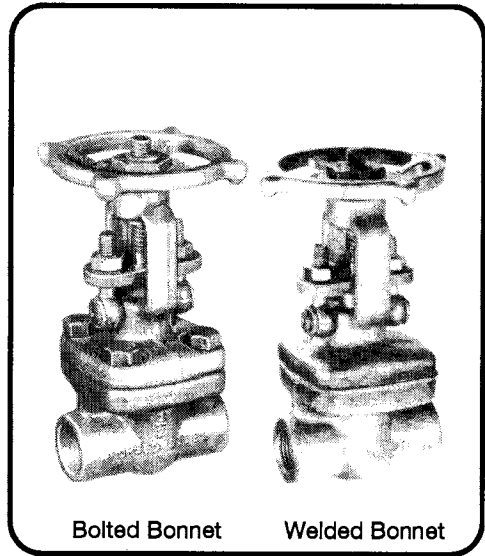
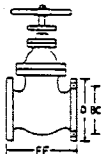

Bolted Bonnet

Welded Bonnet

214121	150-800 LB	Threaded Bolted Bonnet
214131	150-800 LB	Socketweld Bolted Bonnet
215121	150-800 LB	Threaded Weld Bonnet
215131	150-800 LB	Socketweld Weld Bonnet
216121	900/1500 LB	Threaded Bolted Bonnet
216131	900/1500 LB	Socketweld Bolted Bonnet
226131	900/1500 LB	Socketweld Bolted Bonnet

F11 Body High Temperature

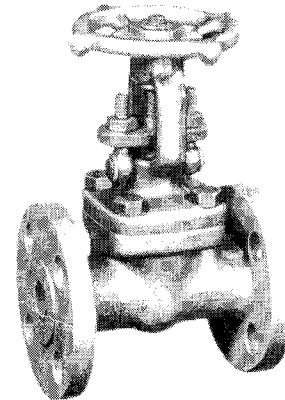

211111	150 LB	Flanged End Bolted
212111	300 LB	Flanged End Bolted
213111	600 LB	Flanged End Bolted
216111	900/1500 LB	Flanged End Bolted

FORGED STEEL

GLOBE & ANGLE

150-300-600/800-1500LB

FLANGED, THREADED or SOCKETWELD ENDS
BOLTED BONNET or WELD BONNET

SIZES: 1/4" to 2"

DESIGN DESCRIPTION

Multi-purpose valve suitable for steam, liquid or gas
Body and bonnet of Carbon Steel (A-105) or Chromemoly (F11/F22)
CR13 Trim with HF Seats
410 Stainless Steel Disc & Stem
316 SS, Monel and Full Stellite Trim available with HF Integral Seats
Available to MIL-V-22094 and Buships Dwgs 2177525, 5184193; pg 155
Metric flanged -please specify drilling standard and face-to-face.

DIMENSIONS (Inches)

150 LB FLANGED

SIZE	1/2	3/4	1	1 1/4	1 1/2	2
FF	4 1/4	4 5/8	5	5 1/2	6 1/2	8
CF	2 1/4	2 1/2	2 3/4	3	3 1/4	4
D	3 1/2	3 7/8	4 1/4	4 5/8	5	6
BC	2 3/8	2 3/4	3 1/8	3 1/2	3 7/8	4 3/4
wt	7	11	13	17	22	35

300 LB FLANGED

SIZE	1/2	3/4	1	1 1/4	1 1/2	2
FF	6	7	8	8 1/2	9	10 1/2
CF	3	3 1/2	4	4 1/4	4 1/2	5 1/4
D	3 3/4	4 5/8	4 7/8	5 1/4	6 1/8	6 1/2
BC	2 5/8	3 1/4	3 1/2	3 7/8	4 1/2	5
wt	9	13	18	28	38	50

600 LB FLANGED

SIZE	1/2	3/4	1	1 1/4	1 1/2	2
FF	6 1/2	7 1/2	8 1/2	9	9 1/2	11 1/2
CF	3 3/8	3 7/8	4 3/8	4 7/8	4 7/8	5 7/8
D	3 3/4	4 5/8	4 7/8	5 1/4	6 1/8	6 1/2
BC	2 5/8	3 1/4	3 1/2	3 7/8	4 1/2	5
wt	10	14	19	29	38	51

900 / 1500 LB FLANGED

SIZE	1/2	3/4	1	1 1/4	1 1/2	2
FF	8 1/2	9	10	11	12	14 1/2
CF	4 5/8	4 1/2	5	6	6	7 5/8
D	4 3/4	5 1/8	5 7/8	6 1/4	7	8 1/2
BC	3 1/4	3 1/2	4	4 3/8	4 7/8	6 1/2
wt	22	35	55	68	77	99

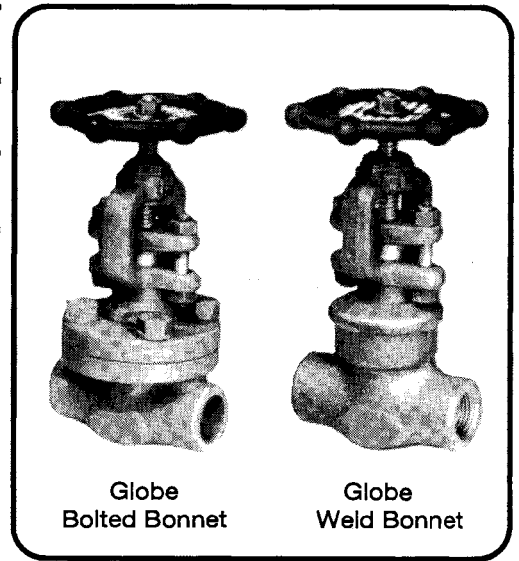

GLOBES: Class	End/Bonnet Type
214321 150-800 LB	Threaded Bolted Bonnet
214331 150-800 LB	Socketweld Bolted Bonnet
215321 150-800 LB	Threaded Weld Bonnet
215331 150-800 LB	Socketweld Weld Bonnet
216321 900-1500 LB	Threaded Bolted Bonnet
216331 900-1500 LB	Socketweld Bolted Bonnet
226331 900-1500 LB	Socketweld Bolted Bonnet

F-11 Body High Temperature

211311 150 LB	Flanged Ends
212311 300 LB	Flanged Ends
213311 600 LB	Flanged Ends
216311 900/1500 LB	Flanged Ends

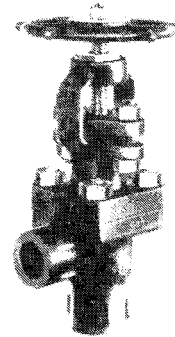
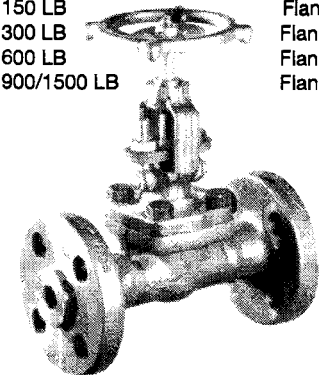

ANGLES: Class	End/Bonnet Type
214421 150-800 LB	Threaded Bolted Bonnet
214431 150-800 LB	Socketweld Bolted Bonnet
216421 900-1500 LB	Threaded Bolted Bonnet
216431 900-1500 LB	Socketweld Bolted Bonnet
226431 900-1500 LB	Socketweld Bolted Bonnet

F11 Body For High Temperature

211411 150 LB	Flanged End Bolted Bonnet
212411 300 LB	Flanged End Bolted Bonnet
213411 600 LB	Flanged End Bolted Bonnet
216411 900/1500	Flanged End Bolted Bonnet

FORGED STEEL SWING, PISTON & BALL CHECK 150-300-600/800-1500LB

FLANGED, THREADED or SOCKETWELD ENDS
BOLTED or WELDED CAP

SIZES: 1/4" to 2"

DESIGN DESCRIPTION

Multi-purpose valve suitable for steam, liquid or gas
Body and bonnet of Carbon Steel (A-105) or Chromemoly (F11/F22)
CR13 Trim with HF Seats
410 SS Disc & Stem
316 SS and Monel trim available
Available to MIL-V-18436
Metric flanged -please specify drilling standard and face-to-face.

DIMENSIONS (Inches)

150 LB FLANGED

SIZE	1/2	3/4	1	1 1/4	1 1/2	2
FF	4 1/4	4 5/8	5	5 1/2	6 1/2	8
D	3 1/2	3 7/8	4 1/4	4 5/8	5	6
BC	2 3/8	2 3/4	3 1/8	3 1/2	3 7/8	4 3/4
wt	6	7	9	14	18	24

300 LB FLANGED

SIZE	1/2	3/4	1	1 1/4	1 1/2	2
FF	6	7	8	8 1/2	9	10 1/2
D	3 3/4	4 5/8	4 7/8	5 1/4	6 1/8	6 1/2
BC	2 5/8	3 1/4	3 1/2	3 7/8	4 1/2	5
wt	7	10	15	21	26	40

600 LB FLANGED

SIZE	1/2	3/4	1	1 1/4	1 1/2	2
FF	6 1/2	7 1/2	8 1/2	9	9 1/2	11 1/2
D	3 3/4	4 5/8	4 7/8	5 1/4	6 1/8	6 1/2
BC	2 5/8	3 1/4	3 1/2	3 7/8	4 1/2	5
wt	7	11	17	23	29	44

1500 LB FLANGED

SIZE	1/2	3/4	1	1 1/4	1 1/2	2
FF	8 1/2	9	10	11	12	14 1/2
D	4 3/4	5 1/8	5 7/8	6 1/4	7	8 1/2
BC	3 1/4	3 1/2	4	4 3/8	4 7/8	6 1/2
wt	18	22	33	46	57	71

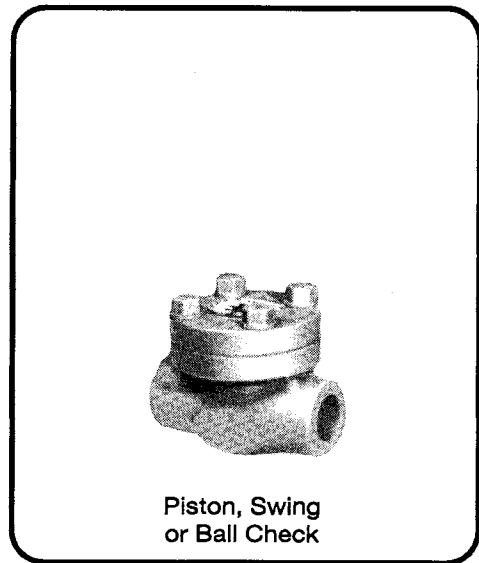
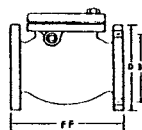

Piston, Swing
or Ball Check

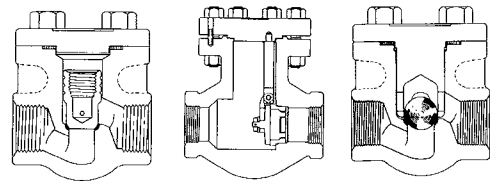

214621	150-800 Threaded	Piston
214521	150-800 Threaded	Swing
214721	150-800 Threaded	Ball
214821	150-800 Threaded	Vertical
214631	150-800 Socketweld	Piston
214531	150-800 Socketweld	Swing
214731	150-800 Socketweld	Ball
214831	150-800 Socketweld	Vertical
216621	900-1500 Threaded	Piston
216631	900-1500 Socketweld	Piston

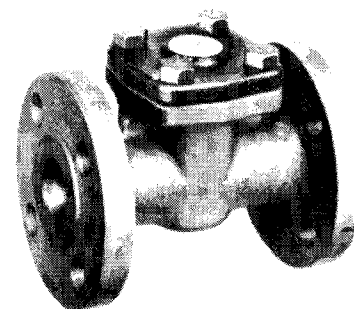

211611	150 LB Flanged	Piston
212611	300 LB Flanged	Piston
213611	600 LB Flanged	Piston
216611	900/1500 LB Flg	Piston
211511	150 LB Flanged	Swing
212511	300 LB Flanged	Swing
213511	600 LB Flanged	Swing

ROCKWELL EDWARDS VALVES 600-900/1500 LB

DESIGN DESCRIPTION

Forged A105 or F11 Body and Bonnet
Fully Guided Disc
Stellite HF Seat and Disc
Stainless Stem
Bolted Bonnet
Available with Stop Check Design

DIMENSIONS (INCHES)

600 LB FLANGED

SIZE	1/2	3/4	1	1 1/4	1 1/2	2
FF	6 1/2	7 1/2	8 1/2	9	9 1/2	11 1/2
CF	3 3/8	3 7/8	4 3/8	4 7/8	4 7/8	5 7/8
D	3 3/4	4 5/8	4 7/8	4 1/4	6 1/8	6 1/2
BC	2 5/8	3 1/4	3 1/2	3 7/8	4 1/2	5
wt	10	14	19	29	38	51

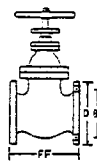

900 / 1500 LB FLANGED

SIZE	1/2	3/4	1	1 1/4	1 1/2	2
FF	8 1/2	9	10	11	12	14 1/2
CF	4 5/16	4 1/2	5	6	6	7 5/16
D	4 3/4	5 1/8	7/8	6 1/4	7	8 1/2
BC	3 1/4	3 1/2	4	4 3/8	4 7/8	6 1/2
wt	22	35	55	68	77	99

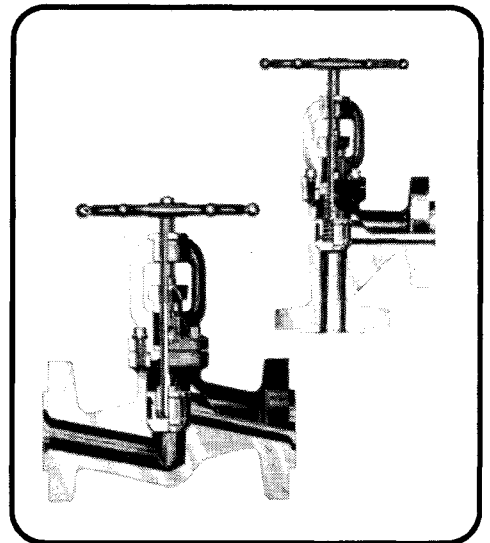
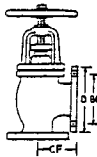

Globe:
600 LB 828 218311
900/1500 (F11) 1028 218511

Angle:
600 LB 829 218411
900/1500 (F11) 1029 218611

Globe Stop Check:
600 LB 846 218312
900/1500 (F11) 1046 218512

Angle Stop Check:
600 LB 847 218412
900/1500 (F11) 1047 218612

ROCKWELL EDWARDS BOILER BLOW-DOWN VALVES 300 - 600 LB

SIZES: 1 1/2" to 2 1/2"

DESIGN DESCRIPTION

Forged A105 Body and Bonnet
Bolted Bonnet
Fully Guided Disc
Stellite HF-Seat and Disc
Stainless Stem

DIMENSIONS (INCHES)

SIZE	300 LB			600 LB		
	1 1/2	2	2 1/2	1 1/2	2	2 1/2
FF	12	12 3/4	14	12 3/8	13 1/8	14 3/8
CF	4 1/2	5 1/4	5 3/4	4 3/4	5 3/4	6 1/2
D	6 1/8	6 1/2	7 1/2	6 1/8	6 1/2	7 1/2
BC	4 1/2	5	5 7/8	4 1/2	5	5 5/8
wt	40	55	90	44	60	95

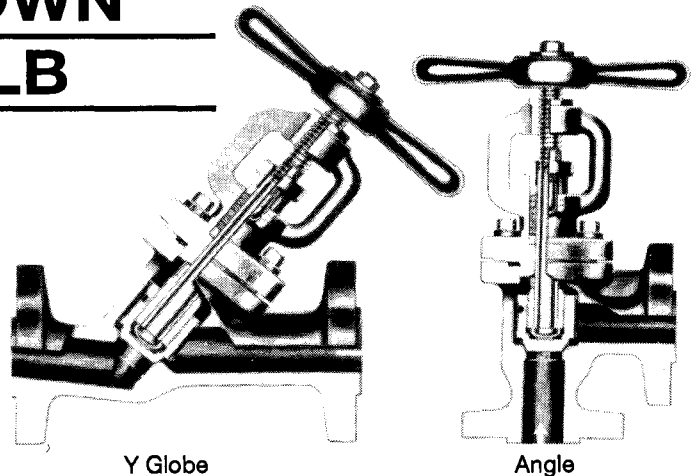

Y Globe
300 LB 1441 219803
600 LB 1641 219813

Angle
300 LB 1443 219903
600 LB 1643 219913

ROCKWELL EDWARDS Y-PATTERN GLOBES 600 - 1500 LB

SIZES; 1/4" to 2"

THREADED OR SOCKETWELD ENDS

DESIGN DESCRIPTION

Forged A105 or F11 Steel Body and Bonnet
Fully guided Disc
Stellite Disc and Seat
Bolted Bonnet

Inclined stem/disc design of Y-pattern Globe provides increased flow compared with standard T-pattern globes.

Available with spring-loaded stop check design.

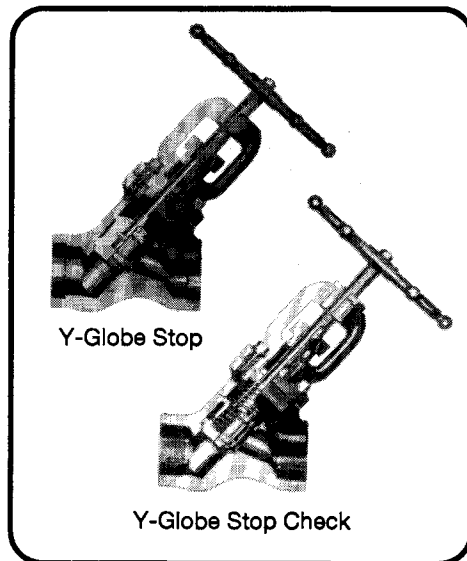

Y-Globe Stop Valve		
600 LB Threaded	848	218721
600 LB Socketweld	848Y	218731
1500 LB Threaded	1048	219721
1500 LB Socketweld	1048Y	219731
1500 Socketweld F11	1048Y F11	219733

Y-Globe Check Valve		
600 LB Threaded	846	218722
600 LB Socketweld	846Y	218732
1500 LB Threaded	1046	219722
1500 LB Socketweld	1046Y	219732
1500 Socketweld F11	1046Y F11	219734

EDWARDS UNIVALVE STOP VALVE Y-GLOBE 1690 - 2680 - 4500 CLASS

SIZES: 1/4" to 2"

SOCKETWELD ENDS

DESIGN DESCRIPTION

Forged A105, F22 or Stainless Body
Fully guided Disc
Stellite HF Disc and Seat
Stainless Stem
Welded Bonnet

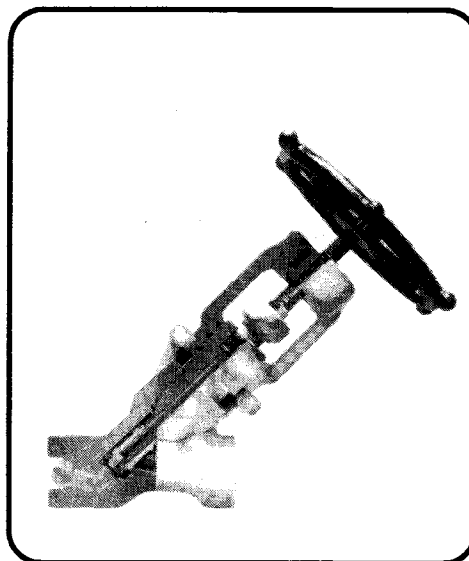

1690 LB	A105	36124	219931
1690 LB	F22	36124 F22	219933
2680 LB	A105	66124	219961
2680 LB	F22	66124 F22	219963
4500 LB	A105	96124	219991
4500 LB	F22	96124 F22	219993

STAINLESS STEEL GATE

150-200 LB

SIZES: 1/4" to 3"

DESIGN DESCRIPTION

Threaded Bonnet or Bolted Bonnet
 Integral Seats
 Threaded, Socketweld or Buttweld ends
 Alloy 20 add "A20" suffix

PARTS AND MATERIAL LIST

DESCRIPTION	MATERIAL	SPECIFICATION
Body	stainless steel	A-351, Grade CF8M
Stem	stainless steel	A-276, Type 316
Bonnet	stainless steel	A-351, Grade CF8M
Disc	stainless steel	A-351, Grade CF8M
Packing gland	stainless steel	A-276, Type 316
Packing nut	stainless steel	A-276, Type 316
Packing	teflon	commercial
Packing collar	stainless steel	A-276, Type 316

Alloy 20 available

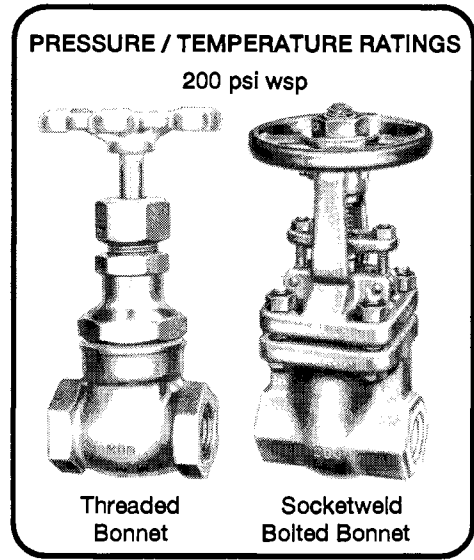

End Type	Bonnet	Number
Threaded	Threaded	173107
Threaded	Bolted	173117
Socketweld	Bolted	173137
Buttweld	Bolted	173147

STAINLESS STEEL GATE

600 LB

**BOLTED BONNET
 OUTSIDE SCREW & YOKE RISING STEM**

SIZES: 1/4" to 3"

DESIGN DESCRIPTION

Fully guided solid disc
 Integral Seats
 Threaded, Socketweld or Buttweld Ends

Alloy 20 add "A20" suffix

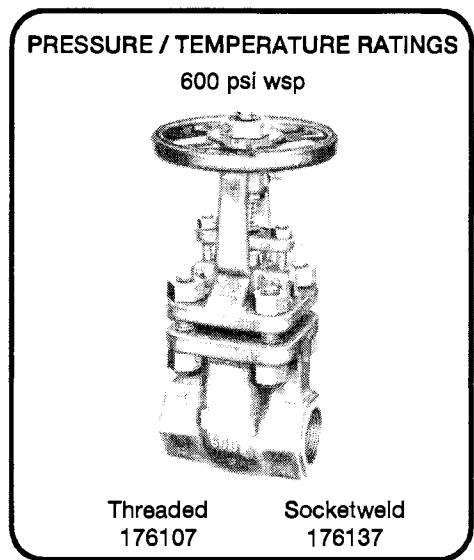

Buttweld Ends
176147

STAINLESS STEEL GATE

150 - 300 - 600 LB

**BOLTED BONNET
OUTSIDE SCREW & YOKE RISING STEM
FLANGED ENDS**

SIZES: 1/2" to 16"

DESIGN DESCRIPTION

Fully Guided Disc
Integral Seats
Also available with buttweld ends

PARTS AND MATERIAL LIST

DESCRIPTION	MATERIAL	SPECIFICATION
Body	stainless steel	A-351, grade CF8M
Bonnet	stainless steel	A-351, grade CF8M
Disc	stainless steel	A-351, grade CF8M
Stem	stainless steel	A-276, type 316
Stem bushing	bronze	B-62
Packing	teflon	commercial
Gasket	teflon	commercial
Yoke	stainless steel	A-351, grade CF8M
Yoke bushing	stainless steel	A-582, type 416
Gland	stainless steel	A-276, type 304
Gland follower	stainless steel	A-276, type 316

Available in Alloy 20

DIMENSIONS (INCHES)

150 LB	1	1 1/4	1 1/2	2	2 1/2	3	4	6	8	10	12	14	16
FF	5	5 1/2	6 1/2	7	7 1/2	8	9	10 1/2	11 1/2	13	14	15	16
D	4 1/4	4 5/8	5	6	7	7 1/2	9	11	13 1/2	16	19	21	23 1/2
BC	3 1/8	3 1/2	3 7/8	4 3/4	5 1/2	6	7 1/2	9 1/2	11 3/4	14 1/4	17	18 3/4	21 1/4
wt	12	18	22	30	42	51	88	158	275	455	675	865	1250

300 LB	1	1 1/4	1 1/2	2	2 1/2	3	4	6	8	10	12
FF	6 1/2	7	7 1/2	8 1/2	9 1/2	11 1/8	12	15 7/8	16 1/2	18	19 3/4
D	4 7/8	5 1/4	6 1/8	6 1/2	7 1/2	8 1/4	10	12 1/2	15	17 1/2	20 1/2
BC	3 1/2	3 7/8	4 1/2	5	5 7/8	6 5/8	7 7/8	10 5/8	13	15 1/4	17 3/4
wt	23	33	40	52	68	102	169	305	500	890	1250

600 LB	1	1 1/4	1 1/2	2	2 1/2	3	4	6	8	10	12
FF	8 1/2	9	9 1/2	11 1/2	13	14	17	22	26	31	33
D	4 7/8	5 1/4	6 1/8	6 1/2	7 1/2	8 1/4	10 3/4	14	16 1/2	20	22
BC	3 1/2	3 7/8	4 1/2	5	5 7/8	6 5/8	8 1/2	11 1/2	13 3/4	17	19 1/4
wt	19	31	41	58	132	171	323	600	1190	1830	2400

PRESSURE / TEMPERATURE RATINGS

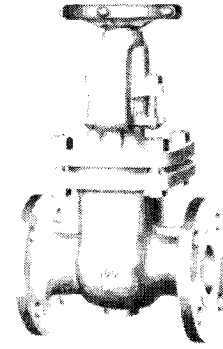

150 LB 072107 - 316SS
082108 - Alloy 20

300 LB 074107 - 316SS
084108 - Alloy 20

600 LB 076107 - 316SS

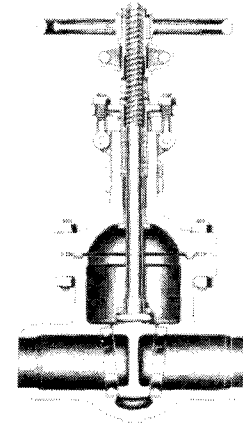

Buttweld Cutaway

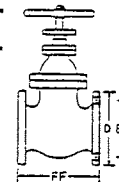

STAINLESS STEEL

GLOBE 150-200 LB

THREADED or BOLTED BONNET

SIZES: 1/4" to 2"

DESIGN DESCRIPTION

Threaded, socketweld or buttweld ends
 Integral seats
 Alloy 20 add "A20" suffix

PARTS AND MATERIAL LIST

DESCRIPTION	MATERIAL	SPECIFICATION
-------------	----------	---------------

Body	stainless steel	A-351, Grade
Bonnet	stainless steel	A-351, Grade CF8M
Disc	stainless steel	A-276, Type 316
Stem	stainless steel	A-276, Type 316
Packing Gland	stainless steel	A-276, Type 316
Packing Nut	stainless steel	A-276, Type 316
Packing	teflon	commercial
Packing Collar	stainless steel	A-276, Type 316
Bonnet Ring	stainless steel	A-351, Grade CF8M
Disc Locknut	stainless steel	A-276, Type 316

PRESSURE / TEMPERATURE RATINGS

200 psi wsp

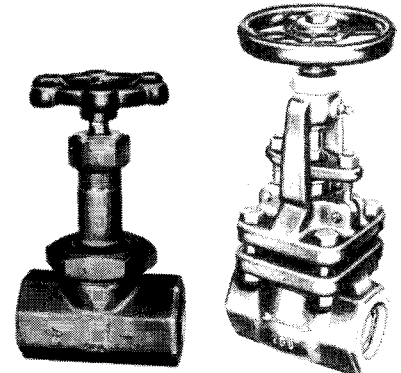

Threaded
Bonnet

Socketweld
Bolted Bonnet

End Type	Bonnet	Number
Threaded	Threaded	173307
Threaded	Bolted	173317
Socketweld	Bolted	173337
Buttweld	Bolted	173347

STAINLESS STEEL

GLOBE 600 LB

BOLTED BONNET
 OUTSIDE SCREW & YOKE RISING STEM

SIZES: 1/4" to 2"

DESIGN DESCRIPTION

Integral seats
 Threaded or socketweld
 Alloy 20 add "A20" suffix

PRESSURE / TEMPERATURE RATINGS

600 psi wsp

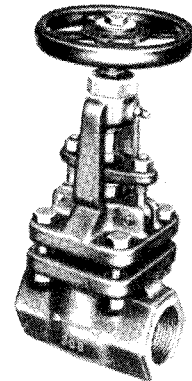

Threaded
176307

Socketweld
176337

STAINLESS STEEL

GLOBE & ANGLE

150 - 300 - 600 LB

BOLTED-BONNET
OUTSIDE SCREW & YOKE RISING STEM
FLANGED END

SIZES: 1/2" to 12"

DESIGN DESCRIPTION

Integral seats
Alloy 20 add "A20" suffix

PARTS AND MATERIAL LIST

DESCRIPTION	MATERIAL	SPECIFICATION
Body	stainless steel	A-351, grade CF8M
Bonnet	stainless steel	A-351, grade CF8M
Disc	stainless steel	A-351, grade CF8M
Stem	stainless steel	A-276, type 316
Stem bushing	bronze	B-62
Packing	teflon	commercial
Gasket	teflon	commercial
Yoke	stainless steel	A-351, grade CF8M
Yoke bushing	stainless steel	A-582, type 416
Gland	stainless steel	A-276, type 304
Gland follower	stainless steel	A-276, type 316

also available in Alloy 20

DIMENSIONS (INCHES)

	1/2	3/4	1	1 1/4	1 1/2	2	2 1/2	3	4	6	8	10	12
150													
FF	4 1/4	4 5/8	5	5 1/2	6 1/2	8	8 1/2	9 1/2	11 1/2	16	19 1/2	24 1/2	27 1/2
CF	2 1/4	2 1/2	2 3/4	3	3 1/4	4	4 1/4	4 3/4	5 3/4	8	9 3/4	12 1/4	13 3/4
D	3 1/2	3 7/8	4 1/4	4 5/8	5	6	7	7 1/2	9	11	13 1/2	16	19
BC	2 3/8	2 3/4	3 1/8	3 1/2	3 7/8	4 3/4	5 1/2	6	7 1/2	9 1/2	11 3/4	14 1/4	17
wt	6	7	11	15	20	29	35	55	115	195	340	640	915
300													
FF	6	7	8	8 1/2	9	10 1/2	11 1/2	12 1/2	14	17 1/2	22	24 1/2	28
D	3 3/4	4 5/8	4 7/8	5 1/4	6 1/8	6 1/2	7 1/2	8 1/4	10	12 1/2	15	17 1/2	20 1/2
BC	2 5/8	3 1/4	3 1/2	3 7/8	4 1/2	5	5 7/8	6 5/8	7 7/8	10 5/8	13	15 1/4	17 3/4
wt	7	11	15	17	28	36	55	76					
600													
FF	6 1/2	7 1/2	8 1/2	9	9 1/2	11 1/2	13	14	17	22			
D	3 3/4	4 5/8	4 7/8	5 1/4	6 1/8	6 1/2	7 1/2	8 1/4	10 3/4	16 1/2			
BC	2 5/8	3 1/4	3 1/2	3 7/8	4 1/2	5	5 7/8	6 5/8	8 1/2	13 3/4			
wt	8	9	11	28	37								

PRESSURE / TEMPERATURE RATINGS

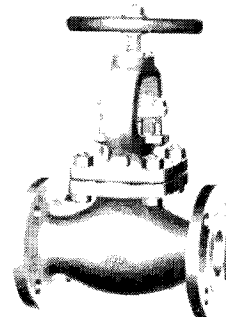

Globe
150 LB - 72307
300 LB - 074307
600 LB - 076307

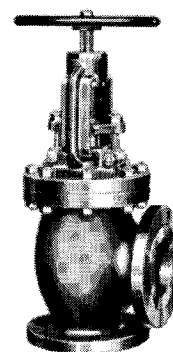

Angle
150 LB - 074107

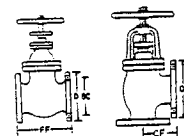

STAINLESS STEEL CHECK 150 - 200 LB

THREADED ENDS or SOCKETWELD ENDS

SIZES: 1/4" to 3"

DESIGN DESCRIPTION

Integral seats
Horizontal or vertical installation
Available with buttweld ends

PARTS AND MATERIAL LIST

DESCRIPTION	MATERIAL	SPECIFICATION
Body	stainless steel	A-351, Grade CF8M
Cap	stainless steel	A-276, Type 316
Carrier Plug	stainless steel	A-276, Type 316
Carrier	stainless steel	A-351, Grade CF8M
Carrier Disc Nut	stainless steel	A-276, Type 316
Disc	stainless steel	A-276, Type 316

Alloy 20 available

STAINLESS STEEL CHECK 600 LB

BOLTED, FLANGED CAP
THREADED or SOCKETWELD ENDS

SIZES: 1/4" to 2"

DESIGN DESCRIPTION

Integral seats
Horizontal or vertical installation
Alloy 20 available

PRESSURE / TEMPERATURE RATINGS

200 psi wsp

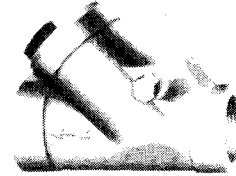

Swing Check
Threaded 173507
Socketweld 173537

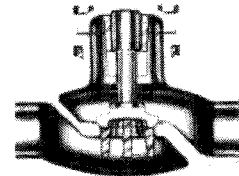

Piston Check
Threaded 173607
Socketweld 173637

PRESSURE / TEMPERATURE RATINGS

600 psi wsp

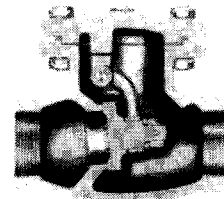

Swing Check
Threaded 176507
Socketweld 176537

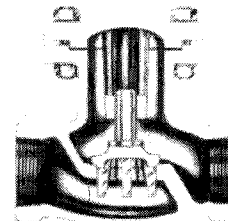

Piston Check
Threaded 176607
Socketweld 176637

STAINLESS STEEL

SWING CHECK

150 - 300 - 600 LB

BOLTED CAP
FLANGED ENDS

SIZES: 1/2" to 12"

PARTS AND MATERIAL LIST

DESCRIPTION	MATERIAL	SPECIFICATION
Body	stainless Steel	A-351, Grade CF8M
Cap	stainless Steel	A-276, Type 316
Carrier Plug	stainless Steel	A-276, Type 316
Carrier	stainless Steel	A-351, Grade CF8M
Carrier Disc Nut	stainless Steel	A-276, Type 316
Disc	stainless Steel	A-276, Type 316
Gasket	teflon	commercial

Alloy 20 available

DIMENSIONS (Inches)

150 LB

SIZE	1/2	3/4	1	1 1/2	2	2 1/2	3	4	6	8	10	12
FF	4 1/4	4 5/8	5	6 1/2	8	8 1/2	9 1/2	11 1/2	14	19 1/2	24 1/2	27 1/2
D	3 1/2	3 7/8	4 1/4	4 5/8	5	6	7	7 1/2	9	11	13 1/2	16
BC	2 3/8	2 3/4	3 1/8	3 1/2	3 7/8	4 3/4	5 1/2	6	7 1/2	9 1/2	11 3/4	14 1/4
wt	6	7	9	17	28	32	40	65	125	230	460	560

300 LB

SIZE	1/2	3/4	1	1 1/2	2	2 1/2	3	4
FF	6	7	8 1/2	9 1/2	10 1/2	11 1/2	12 1/2	14
D	3 3/4	4 5/8	4 7/8	5 1/4	6 1/8	6 1/2	7 1/2	8 1/4
BC	2 5/8	3 1/4	3 1/2	3 7/8	4 1/2	5	5 7/8	6 5/8
wt	7	12	16	28	40	60	68	90

600 LB

SIZE	1/2	3/4	1	1 1/2	2	2 1/2	3
FF	6 1/2	7 1/2	8 1/2	9 1/2	11 1/2	13	14
D	3 3/4	4 5/8	4 7/8	5 1/4	6 1/8	6 1/2	7 1/2
BC	2 5/8	3 1/4	3 1/2	3 7/8	4 1/2	5	5 7/8
wt	11	16	19	40	52	70	83

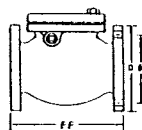

PRESSURE / TEMPERATURE RATINGS

150 psi wsp 550° F
400 psi wog -20 to 150° F

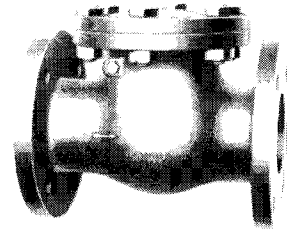

Swing Check
072507 150 LB 316SS
082508 150 LB Alloy 20

074507 300 LB 316SS
076507 600 LB 316SS

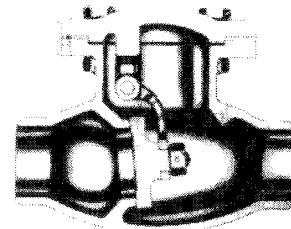

Buttweld End Cutaway

OPERATORS, OPTIONS & MODIFICATIONS

Valve modifications and options are many. Some that we perform are shown below.
*Actuation is described on next page. Not shown: Epoxy coating, extended stem.

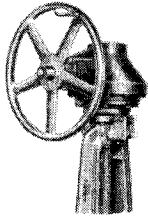

Bevel Gear
Angle Type

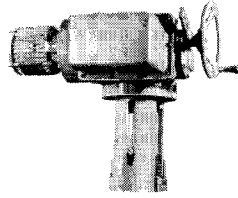

Pneumatic, Electric
Hydraulic Actuation

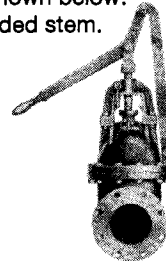

Quick Open
Gate

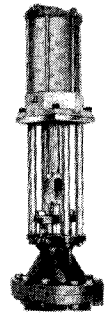

Cylinder
Operator

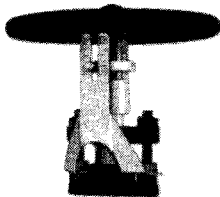

Indicator
For NRS Valves



Hammerblow
Handwheel

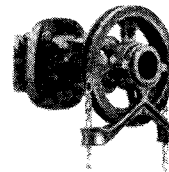

Chainwheel
Sprocket Type

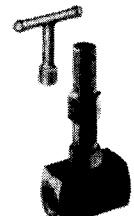

Lockshield
and Key

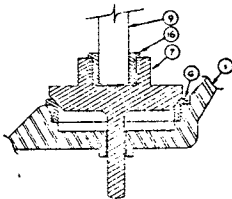

Stop Check
Non-Return



Special
Trim



Special
Gaskets, Fasteners



Custom Welding



Clean Out

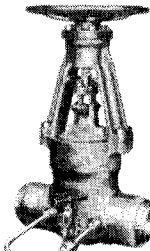

Bypass
Equalizer

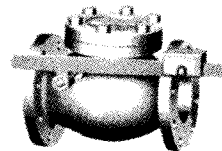

Lever &
Weight

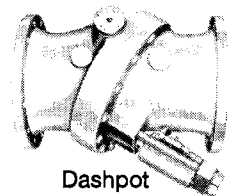

Dashpot

TESTING & APPROVALS

For critical service and some ship overboard applications, rating society witnessed and certified, tested and approved valves and materials are offered at fees set by these groups and our testing facilities. Such societies include:

- DNV
- Lloyds Registry
- American Bureau of Shipping

We can supply general compliance certification for valves, pipes and fittings at normal cost.



OPERATORS, COUPLINGS & JOINTS

These items provide means for remote mechanical operation of manually controlled valves; typically used with rigid type or flexible type reach rods.

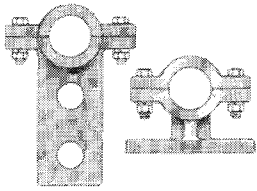

Shaft Hanger
& Mounting Bracket

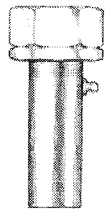

Stuffing Box

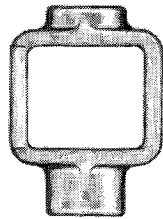

Valve Yokes

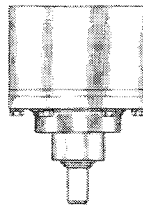

Deck Box Operator

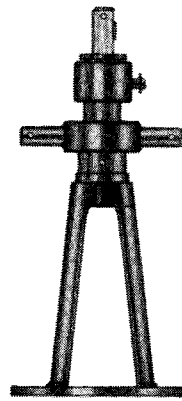

12129 Remote Operator
Rising Stem



12103
Weld Type

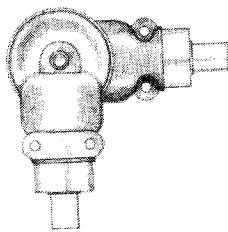

Swivel Gear Joint

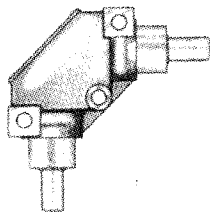

90° Gear Box

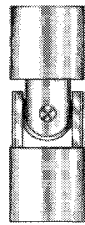

Universal Joint

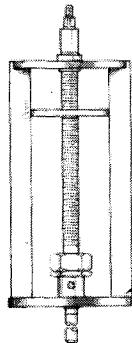

Deck/Floor Stand
Operator With Indicator

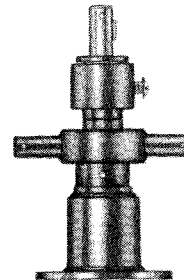

12127 Valve Couplings
Non-rising

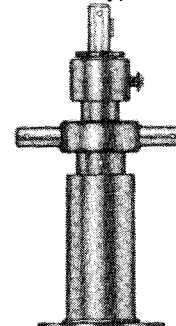

12128
Handwheel
Rising

HANDWHEELS

A variety of replacement spare handwheels are available. Dimensions below cover aluminum or malleable iron ribbed-rim handwheels (523901) for square stem valves, and, flat rim wheels in bronze (523902) or aluminum (523903) for hex or square stems: wheel diameters 3" to 24". Please specify measurement, and square or hex, across the flat sides of stem*. This type is available blank with no hole if that is preferred.

Round rim wheels in iron or steel (523904), some stainless steel (523905) with square or hex. Specify OD and hole size*, hex or square.

Name	523901 Ribbed Type								
	Size 1/2	3/4	1	1 1/4	1 1/2	2	3	4	5
O. Diameter	1 3/4	2	2 1/4	2 3/4	3 1/8	3 7/8	4 1/4	5	6
Hole Dia. in	.250	.250	.250	.355	.280	.400	.438	.500	.531
mm	6.35	6.35	6.35	9.0	7.1	10	11	12.5	13.5

Name	523902 Bronze				523903 Aluminum			
	Size 2	3	4	6	8	10	12	14
O. Diameter	3	4	5	6-7-8	9-12	14-20	24	
Hole Dia.* in	9/32	5/16	3/8	9/16	3/4	13/16	13/8	
mm	7.1	8	9.5	14.3	19	30	35	

ACTUATION

For installation of actuation devices: pneumatic, electric, hydraulic, or manual gear operator, some details should be identified:

- 1) Pipe size of valve and valve type.
- 2) Line media and its pressure and temperature range at the valve.
- 3) Power operating in both directions, opening and closing — (this is called double acting)? Or power one way and coil spring return? If this: spring-to-close ("fail safe") or spring-to-open ("fail open")?
- 4) Full-open to and from full-close? Or positioning between the two for throttling, modulating service?
- 5) As an electric solenoid may be required to implement your requirement: voltage level available for use. Double acting requires a 4-way solenoid, spring return a 3-way.
- 6) Force available to power the actuator, not at the generating point, but at the actuator location. In psi or voltage.

It may be helpful to understand: the force — in foot-pounds — required at the valve stem to operate the valve at service conditions. Valve model number and manufacturer can determine this.

Is a switch required that will signal the completion of the actuation cycle? Electrical, mechanical, or solid state "limit" switch?

Is a specific "manual override" mechanical device required to operate the valve in the event of power loss?

** or holes to your specification, or wheels blank no hole
* measurement at larger end of taper through the wheel

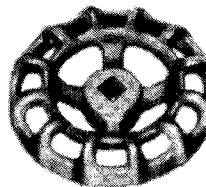

BUTTERFLY VALVES

RESILIENT SEATED

ANSI & METRIC

SIZES: 1 1/2" to 54", 40mm to 700mm

Valves are stocked to European DIN, Japanese JIS as well as US ANSI and Navy standards. Flanges to suit each also stocked.

There is a wide range of choices of types and configurations of these valves. Most common is wafer or lug style in cast iron body, with bronze, monel or stainless steel disc and buna or EPDM seat. Operation by lever or mechanical gear. Another typical choice: Wafer or lug style in ductile iron or bronze body.

By specifying line medium + service application, recommendations can be made. In the case of mechanical actuation, line pressure should be identified.

Some sizes of wafer style incorporate a 2 or 4 pattern alignment/guide hole system as shown upper right. Less common is a true double flanged body and monoflanged (DIN) style.

Further metric details in page 62.

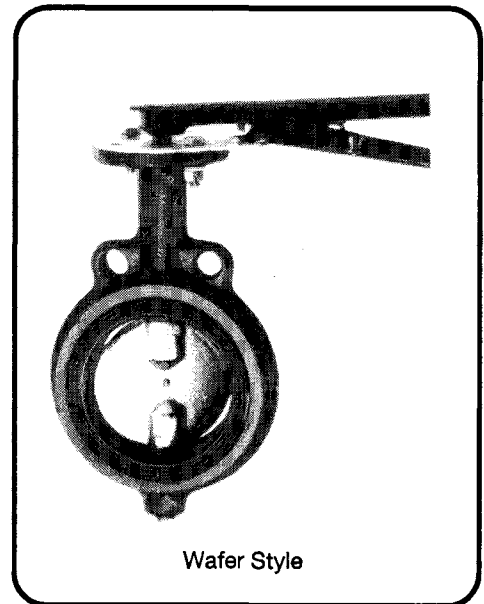

Wafer Style

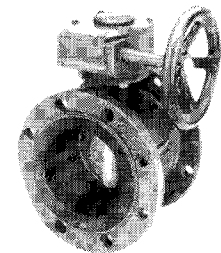
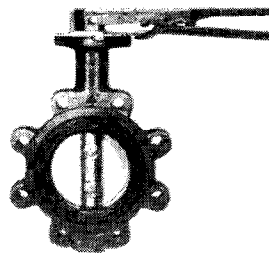
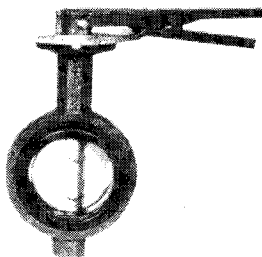

Body Material	WAFER STYLE	Body Material	LUG STYLE	Body Material	FLANGED	
Cast Iron	Bronze Disc	312102	Bronze Disc	312202	Bronze Disc	312302
	Stainless Disc	312107	Stainless Disc	312207	Stainless Disc	312307
	Monel Disc	312104	Monel Disc	312204	Monel Disc	312304
	NI Plated Disc	312101	NI Plated Disc	312201	NI Plated Disc	312101
	Teflon Lined	312108				
Ductile Iron	Bronze Disc	313102	Bronze Disc	313202	Bronze Disc	313302
	Stainless Disc	313107	Stainless Disc	313207	Stainless Disc	313307
	Monel Disc	313104	Monel Disc	313204	Monel Disc	313304
	NI Plated Disc	313101	NI Plated Disc	313201		
Steel	Bronze Disc	311102	Bronze Disc	311202		
	Stainless Disc	311107	Stainless Disc	311207		
	Monel Disc	311104	Monel Disc	311204		
Bronze	Bronze Disc	325102	Bronze Disc	325202		
	Monel Disc	325104	Monel Disc	325204		
Aluminum	Aluminum Disc	319709				
	Stainless Disc	319707				



Monoflange Style to DIN
Untapped Boltholes

All of the above valves are typically supplied with Buna liner and lever operator for ANSI standard joining flanges unless otherwise specified. See following for additional liner and joining flange standards. Additional operator information pages 60, 63. Please specify liner:

BUNA	Suitable for salt water, oil, and general purposes	Max. temp. 180° F
EPDM	Suitable for salt water and steam (not oil)	Max. temp. 250° F
VITON	Suitable for aromatics (e.g., gasoline) and steam	Max. temp. 300° F
HYPALON	Specific chemical applications	Max. temp. 180° F
TEFLON	Specific chemical applications	Max. temp. 250° F
METAL	See page 63	

Please specify mating flange standard: ANSI, DIN PN6, DIN PN10, DIN PN16, JIS 5K, JIS 10K (pages 97-98)

METRIC BUTTERFLY VALVES

SIZES: 40mm to 750mm
JIS and DIN

Wafer, Lug, Flanged styles in Iron, Ductile (Nodular) Iron Body, Rubber Seat. Refer to numbers and options below. Standard valve is wafer iron body, buna liner, lever.

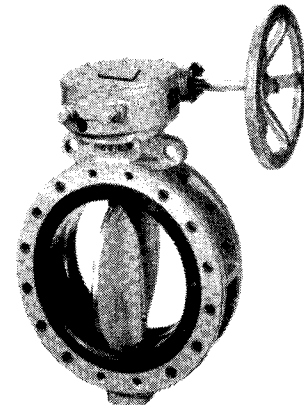
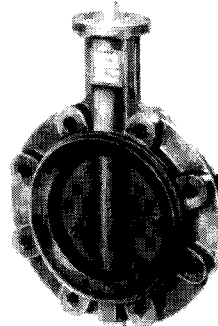
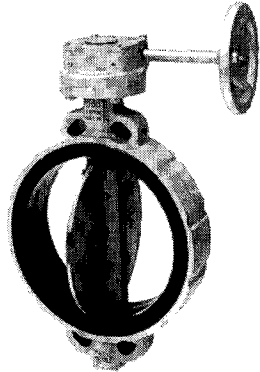
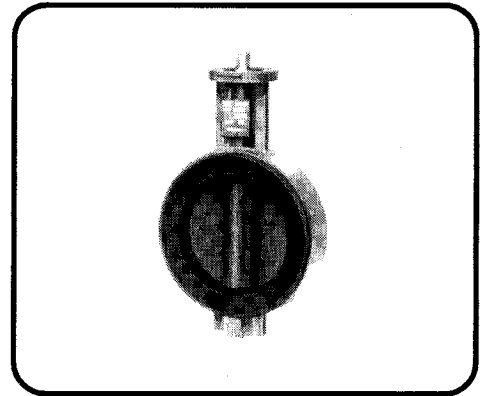

		Wafer	Lug	Flanged
5K JIS	Brz Disc	949102-5	949202-5	949302-5
	SS Disc	949107-5	949207-5	949307-5
10K JIS	Brz Disc	949102-10	949202-10	949302-10
	SS Disc	949107-10	949207-10	949307-10
PN 6 DIN	Brz Disc	949402-6	949502-6	949602-6
	SS Disc	949407-6	949507-6	949607-6
PN 10 DIN	Brz Disc	949402-10	949502-10	949602-10
	SS Disc	949407-10	949507-10	949607-10
PN 16 DIN	Brz Disc	949402-16	949502-16	949602-16
	SS Disc	949407-16	949507-16	949607-16

Options available: Ductile (Nodular) Iron body: add DI to item number
 Monel Disc add MD to item number
 Gear Operator add GO to item number
 Viton Seat/Liner add VS to item number
 EPDM Seat/Liner add EP to item number

TOMOE®

SIZES: 40mm to 750mm

Wafer, Lug (shown above), Flanged styles in Iron, Ductile (Nodular) Iron, Steel, Aluminum body, Rubber Seat. Numbers and options below. Standard valve is wafer iron body, buna liner, lever operator.

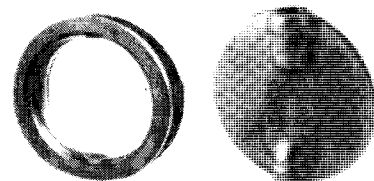

Replacement Seats

Replacement Discs

		700 S Wafer Cast Iron	700 Z Wafer Aluminum	720 F Flanged Cast Steel
5K	Brz Disc	949702-5	949708-5	949722-5
	SS Disc	949707-5	949709-5	949727-5
10K	Brz Disc	949702-10	949708-10	949722-10
	SS Disc	949707-10	949709-10	949727-10

Options available: Ductile (Nodular) Iron body: add DI to item number
 Lug Style (shown above) add LG to item number
 Gear Operator add GO to item number
 EPDM Seat/Liner add EP to item number



Lever Opt.

BUTTERFLY VALVES

HIGH PERFORMANCE

ANSI

SIZES: 2" to 24"

High Performance Butterfly Valves are used in highly specialized applications and are much more costly than traditional resilient seated type valves. A variety of designs exist most of which have wetted body in contact with the flow medium, a small primary teflon profile seal and elastomer o-ring seal in conjunction with a secondary metal seat which is stable at elevated temperature, and thus in the event of destruction of primary seat provides a controlled leakage factor.

Available wafer or lug style with bronze, stainless steel or steel body, disc in stainless steel, steel or monel, operation by lever or actuator. Typically rated ANSI class 150 with PSI to 285 LBS. Some designs mate class 300/740 PSI.

Manufactured primarily to ANSI and Navy standards, however some sizes fit metric applications, or matching flanges be supplied.

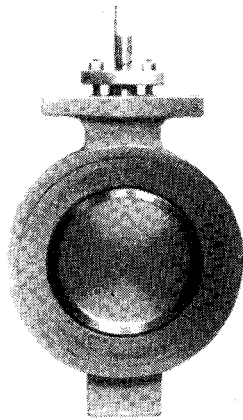
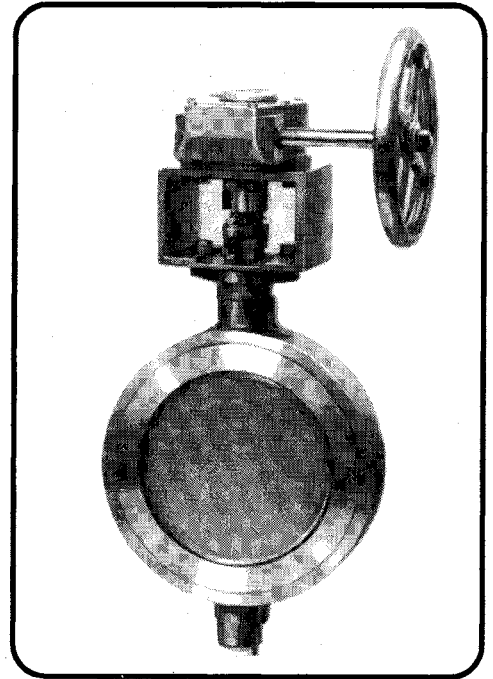

Wafer

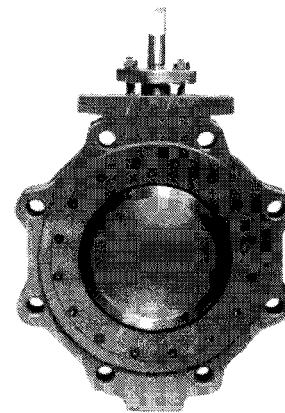
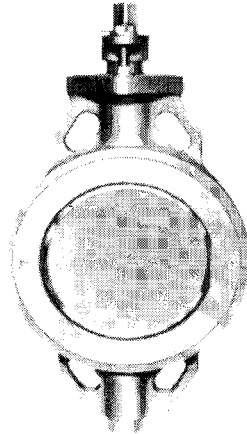

Lug

Bronze Body
Steel Body
Stainless Body

Monel Disc
Stainless Disc
Stainless Disc

325504
337507
331507

Bronze Body
Steel Body
Stainless Body

Monel Disc
Stainless Disc
Stainless Disc

325604
337607
331607

Above valve configurations are typically supplied with teflon primary seal. Metal seated high performance butterfly valves are available upon request.

Please specify operator type (see below).

OPERATOR TYPES

Specify line pressure, medium, and service requirements as identified on page 60.

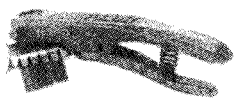

Lever
Handle

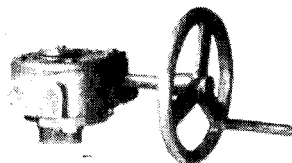

Manual
Gear

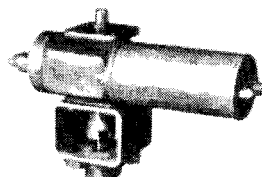

Pneumatic
Actuator

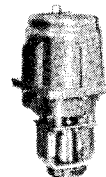

Electric
Actuator



Hydraulic
Actuator

METRIC VALVES

FORGED STEEL

SIZES: 15mm to 40mm

Flanged ends
 Forged steel body
 Stainless trim

Also available with thread or socket ends

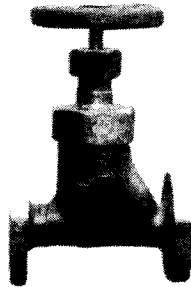
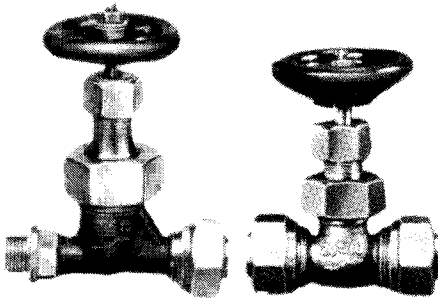
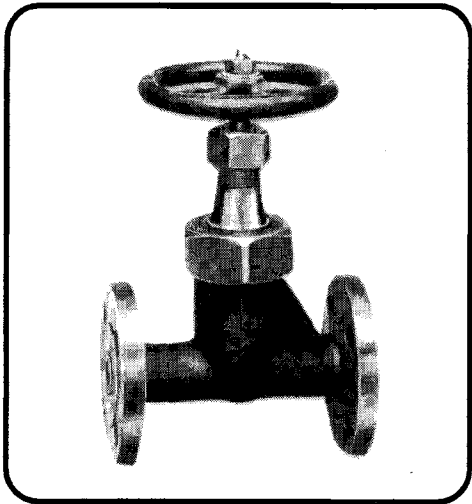

Male Thread by
 Union Socket
 6 & 10 mm

Double Union
 Socketweld
 6 & 10 mm

Globe	Angle
20K 914301	20K 914401
40K 916301	40K 916401
15 to 25 mm	15 to 25 mm

20K JIS Globe F-7421, Angle F-7422

Size	15	20	25	32	40
FF	140	160	180	See cast	
CF	75	80	95	steel	
D	95	100	125	pg 131	
BC	70	75	90		
wt (kg)	4	5	7		

40K JIS Globe F-7329, Angle F-7330

Size	15	20	25
FF	150	170	200
CF	90	95	100
D	115	120	130
BC	80	85	95
wt (kg)	6	7	10

METRIC VALVES

MALLEABLE IRON

SIZES: 15mm to 40mm

Flanged ends
 Bronze or SS trim

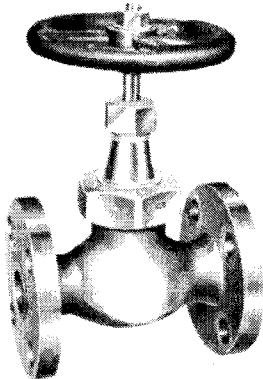

Globe
 5K 921303
 16K 923303

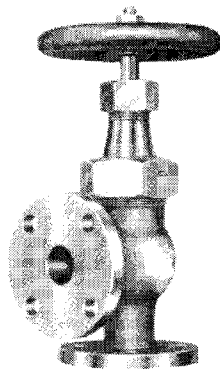

Angle
 5K 921403
 16K 923403

5K JIS Globe F-7321, Angle F-7322

Size	15	20	25	32	40
FF	100	110	120	140	160
CF	55	60	65	80	85
D	80	85	95	115	120
BC	60	65	75	90	95
wt (kg)	2	3	4	5	6.5

16K JIS Globe F-7323, Angle F-7324

Size	15	20	25	32	40
FF	110	120	130	160	180
CF	70	75	85	95	100
D	95	100	125	135	140
BC	70	75	90	100	105
wt (kg)	3	4	5	7	9

BALL VALVES

SIZES: 1/4" to 12"

DESIGN DESCRIPTION

Ball valves are available in straightway design for quarter-turn on/off applications or multiport for diverter functions. Ball valves can be supplied in a wide variety of materials, style, end connections, and pressures. Standard port (bore) is reduced, though full port design is available in most styles. Fire-safe ball valves are also available. Typical ball valves are constructed with teflon seats and as such have limited temperature service range. Metal seated ball valves are available for severe or high temperature service.

Bronze ball valves are typically rated 400/600 WOG. Steel and stainless are typically 800/2000 WOG. Special high pressure ball valves can be supplied in steel or stainless rated 3000 WOG.

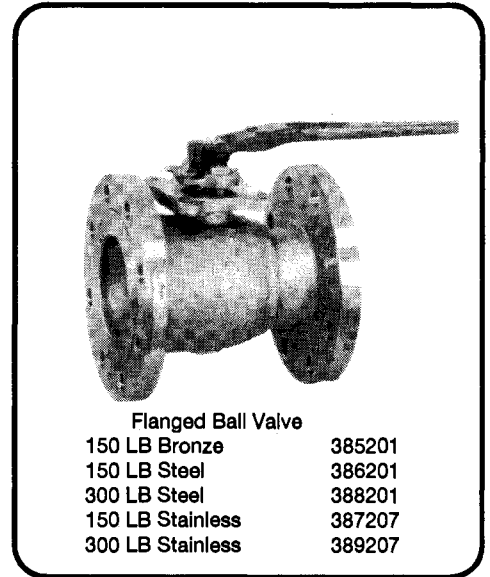

Flanged Ball Valve
 150 LB Bronze 385201
 150 LB Steel 386201
 300 LB Steel 388201
 150 LB Stainless 387207
 300 LB Stainless 389207

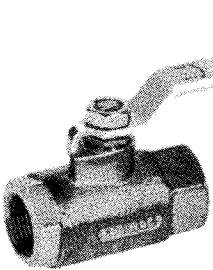

1-Piece or 2-Piece Economy Style
 Threaded or Solder Ends
 Not Suitable For Socket-welding or Silbraze
 Bronze Thrd 375202
 Bronze Solder 374202
 Steel Thrd 376201
 Stainless Thrd 377207

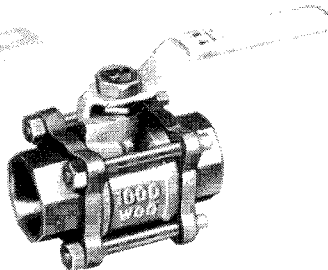

3-Piece Threaded Socketweld or Silbraze Ends
 Bronze Thrd 375302
 Bronze S/B 375332
 Steel Thrd 376301
 Steel SW 376331
 Stainless Thrd 377307
 Stainless SW 377337

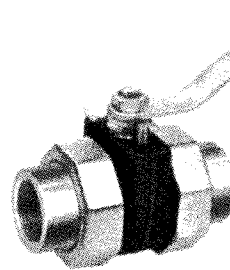

Union End Threaded, Socketweld or Silbraze
 Bronze Thrd 375502
 Bronze S/B 375532
 Steel Thrd 376501
 Steel SW 376531
 Stainless Thrd 377507
 Stainless SW 377537

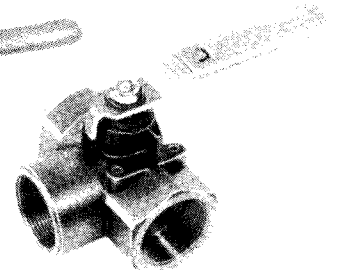

3-Way Multiport Diverter
 Bronze Thrd 375902
 Stainless Thrd 377907
 Bronze Flanged 385303
 Steel Flanged 386301
 Stainless Flngd 387307

Change last digit to:
 3 to order full port
 7 to order stainless ball
 9 full port SS ball

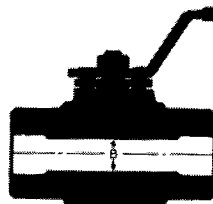

Standard Port

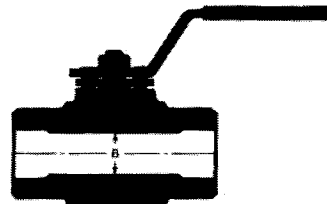

Full Port

Lever / Operator Options:

- Stainless Lever
- Round Handle for space limited applications
- Locking Lever
- Deadman Spring Return Lever
- Gear Operator
- Motor Operator - Electric, Pneumatic, or Hydraulic

OTHER BALL VALVES

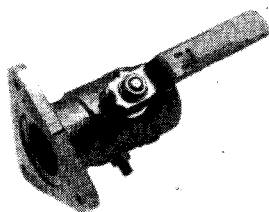

Tank Mount



Ball-o-fix
 Compression, FPT, MPT

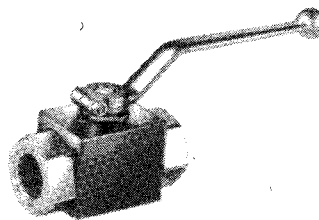

High Pressure
 3-10,000 PSI



Butterball
 Thread end

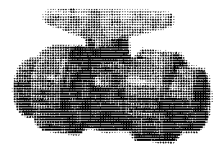

PVC
 True Union

PLUG VALVES & COCKS

SIZES: 1/8" to 12"

MATERIALS:

- Bronze
- Cast iron
- Cast steel
- Stainless steel

Plug valves are used in straightway patterns for quarter turn on/off service applications and in multiport patterns for diverter applications. The most common design is lubricated plug valve. Steam base plate (shown right) is an optional feature to keep lubricant and medium fluid. Ports (waterway or bore through plug) are standard rectangular but can be provided with round ports for improved flow. Eccentric plug valves also can be supplied to provide increased flow. Spare lever wrenches and lubricant sticks can be supplied.

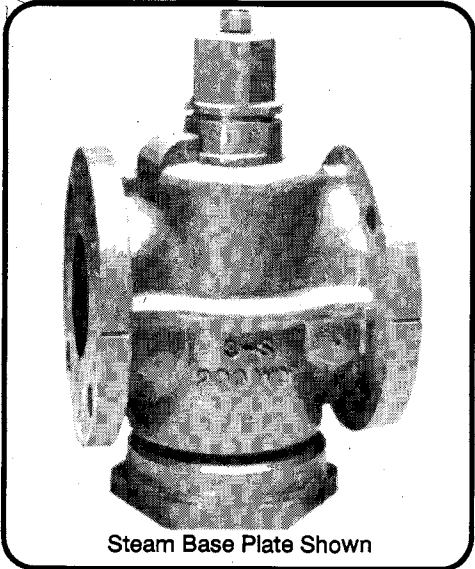

Steam Base Plate Shown

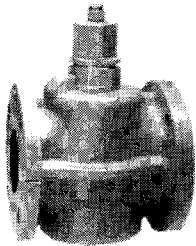

Straightway
2 way 2 port

Bronze Flanged	355202
Iron Flanged	352202
Steel Flanged	351202
Stainless Flanged	357202
Iron Threaded	352202

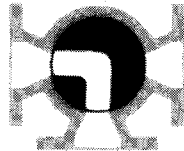

Multiport
3 way 2 port (L port)

Bronze Flanged	355302
Iron Flanged	352302
Steel Flanged	351302
Stainless Flanged	357302
Iron Threaded	352302

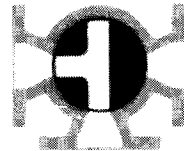

Multiport
3 way 3 port (T port)

Bronze Flanged	355303
Iron Flanged	352303
Steel Flanged	351303
Stainless Flanged	357303
Iron Threaded	352303

Plug cocks are standard rectangular port for shutoff or diverter application, ends are threaded. Valves are operated by a quarter turn of lever wrench or tee handle.

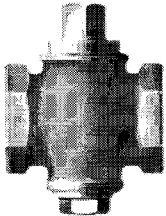

Straightway
2 way 2 port

Bronze	345202
Iron	342102
Steel	341202
Stainless	347202



MultiPort
3 way 2 port

Bronze	345302
Iron	342102
Steel	341302
Stainless	347302



MultiPort
3 way 3 port

Bronze	345303
Iron	342103
Steel	341303
Stainless	347303

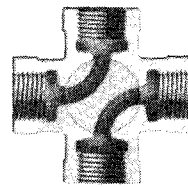

MultiPort
4 way 4 port

Bronze	345404
Iron	342104
Steel	341404
Stainless	347404

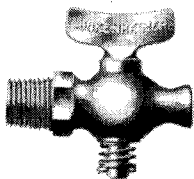

Straight Nose
Pet Cock 527102

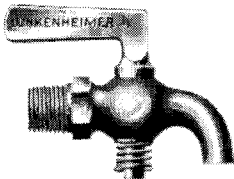

90° Bibb Nose
Drain Cock 527101

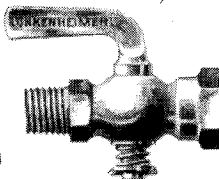

MPT x FPT
Air Cock 527301

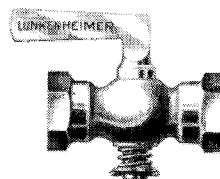

FPT x FPT
Air Cock 527104

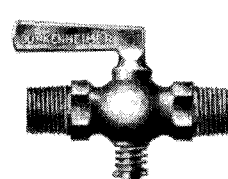

MPT x MPT
Air Cock 527105

WAFER CHECKS

SIZES: 2" to 36"

DESIGN DESCRIPTION

Wafer checks are designed to fit within the bolting circle of joining flanges and are rated to match the flange rating: 125/150, 250/300, 600 LB. Wafer checks are typically of three types: Duo-Check, Swing Check and Silent Check, and have resilient or metal-to-metal seating. Metric sizes available.

Duo-Checks are designed with two half circle discs or plates that hinge on a center hinge pin. The spring loaded plates are opened by the flow of the medium and close automatically. Duo-Checks are suitable for installation in any horizontal or vertical position.

Wafer swing checks operate similarly to standard swing checks with the single disc hinged at the top closing by gravity. Wafer swing checks can be supplied with internal or external springs or outside lever to facilitate closing.

Silent checks are designed to bolt between joining flanges in vertical installations. The flow lifts the disc which will close by gravity as pressure/flow stops. The check mechanism is typically spring loaded to protect against water hammer problems. Silent checks are typically metal seated.

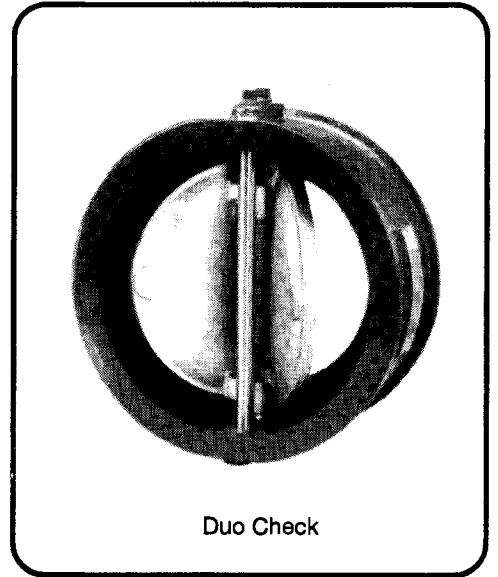

Duo Check

Iron	302202
Steel	302101
Bronze	302502
Stainless	302707

PARTS AND MATERIALS CHOICES:

Body	Disc	Resilient Seat	Metal Seat
Bronze	Stainless steel	Buna-N	Bronze
Cast Steel	Monel	EDPM	Stainless
Cast Iron	Bronze	Teflon	
Stainless steel	Cast Iron	Viton	
	Cast Steel	Neoprene	

Ordering Info:
 Seat type and material
 Matching flange rating / drilling

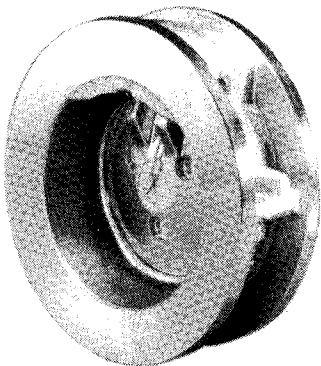

Wafer
Swing Check
 Iron 305202
 Steel 305101
 Bronze 305503
 Stainless 305707

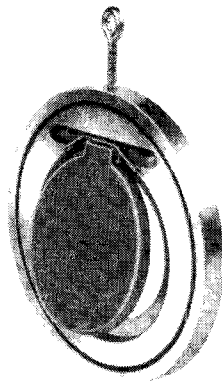

Thin Wafer Style
Swing Check
 Steel 308101
 Bronze 308502
 Stainless 308707



Silent Check
 Iron 306202
 Steel 306101
 Bronze 306502

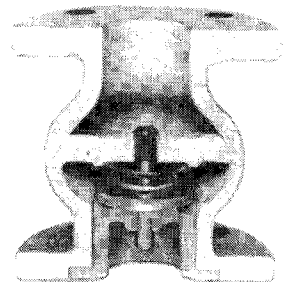

Silent Check Globe
 Iron 308202
 Steel 308101
 Bronze 308502

KNIFE GATE

150 LB

SIZES: 2" to 24"

DESIGN DESCRIPTION

Solid, one piece body cast in corrosion resistant stainless steel
 Compact wafer configuration to Tappi standard TIS 405-8
 Bonnetless, outside screw and yoke, non-rising handwheel, rising stem
 Smooth flow, non-clogging full port design
 Designed to handle dense mixtures of stock and slurries
 Shearing action of knife gate cuts through solids and cleans seat as it closes
 Gate and seat machined and fitted to provide shut off in one direction
 Flanges match ANSI B16.5-150 lb standard with tapped holes & serrated gasket faces.
 DIN standards upon request.

Also available in cast iron and cast steel body

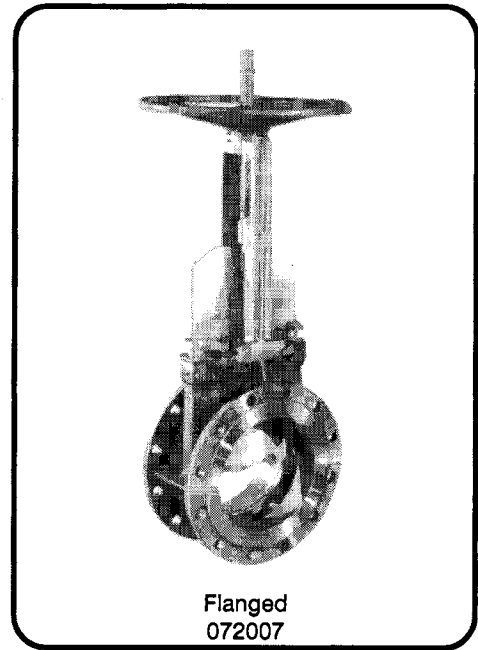

Flanged
072007

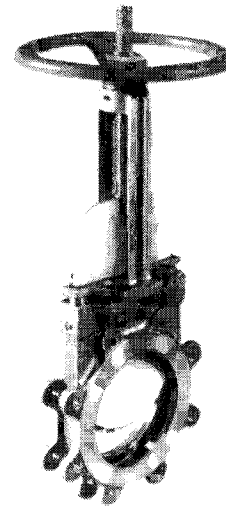

Lug
072006

PARTS AND MATERIAL LIST

DESCRIPTION	MATERIAL	SPECIFICATION
Body*	stainless steel	A-351 Grade CF8M
Gate	stainless steel	A-351 Grade CF8M
Seat*	stainless steel	A-351 Grade CF8M
Bolts	stainless steel	A-351 Grade CF8M
Packing	TFE impregnated	commercial
Gland	stainless steel	A-351 Grade CF8M
Stem	stainless steel	A-351 Grade CF8M
Yoke	stainless steel	A-351 Grade CF8M
Stem nut	brass	A-124

* also available with teflon inserted resilient seat (072007RS flanged)
 (072006RS lug)

DIMENSIONS (Inches)

SIZE	2	3	4	5	6	8	10	12	14	16	18	20	24
Face to Face	17/8	2	2	2 1/4	2 1/4	2 3/4	2 3/4	3	3	3 1/2	3 1/2	4 1/2	4 1/2
Flange Diameter	6	7 1/2	9	10	11	13 1/2	16	19	21	23 1/2	25	27 1/2	32
Bolt Circle	4 3/4	6	7 1/2	8 1/2	9 1/2	11 3/4	14 1/4	17	18 3/4	21 1/4	22 3/4	25	29 1/2
Ctr to top - closed	13 3/4	16	18 5/8	22	24 1/4	26 1/4	29 7/8	33 7/8	36 3/4	40 7/8	45 1/4	50 1/4	58 3/4
Ctr to top - open	17	19 1/4	23	27	30 5/8	34 5/8	40 1/8	46 1/8	51 1/4	57 1/4	63 5/8	71	83 3/4
weight (LB)	20	29	38	45	52	85	120	160	212	300	350	480	600

DIAPHRAGM VALVE

SIZES: 1/4" to 16"

Consists of body and top bonnet with elastomer membrane or diaphragm between the two. Body can be lined or unlined. Choices and service applications are listed below. When uncertain of best construction: specify medium, temperature and pressure when inquiring.

Valves are female threaded, socket or flanged ANSI, DIN or JIS standards. Face to face dimensions may vary by manufacturer.

Weir type or A type is the most common style - it can operate in any position and is ideal for throttling service as well as positive shut-off. Body design gives unrestricted flow with some pressure drop through valve. Generally 175 PSI at 120°F. with maximum temperature according to membrane limitation.

Straight-through or KB type has a straight full-open bore well suited for abrasive or coagulating media. Generally designed for maximum pressure of 150PSI at 120°F.

BODY MATERIALS:

Cast iron or ductile iron for general purposes. Optional hard rubber lined suited for effluent brine and water treatment services. Temperature limit at 185°F.

Butyl lined for acids and inert gases to 250°F.

Other choices include bodies of Bronze, PVC, Stainless Steel and linings to suit most applications.

DIAPHRAGM MATERIALS:

Diaphragms are specified by material or application, pipe size and valve type. Identification also possible with drawing of bolt pattern of diaphragm.



NITRILE RUBBER ("C") fuel oils, mineral oils to 212°F*
 ETHYLENE PROPYLENE ("E") general purpose; hot water to 300°F*
 BUTYL Grade 300 ("D") general purpose to 300°F*
 NEOPRENE ("HT") general purpose; compressed air to 212°F*
 NATURAL/ SYN. RUBBER ("Q") abrasives, salts to 212°F*
 TFE/BUTYL BACKED** ("P1") high chemical resistance to 350°F*

Other choices include: Butyl Rubber, Hypalon, Viton, and TFE with EP, Hypalon or Viton backing.

Note: TFE diaphragms have a bayonet fitting connection to compressing stem. Standard types use a thread-on connection mounting.

* Temperature limitations for KB type are approx 10% less.

** Bayonet post, not threaded stud.

DIMENSIONS

Size	1/2	3/4	1	1 1/4	1 1/2	2	2 1/2	3	4	6	8	10	12	in
FF	4	4 5/8	5	5 3/4	6 1/4	7 1/2	8 1/2	10	12 1/2	16	20 1/2	25	29 1/2	

Size	15	20	25	32	40	50	65	80	100	125	150	200	250	mm
FF	130	150	160	180	200	230	290	310	350	400	480	600	730	

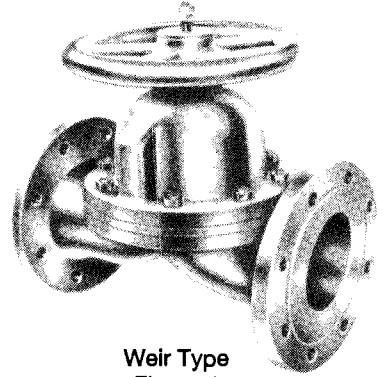

Weir Type
Flanged
536201

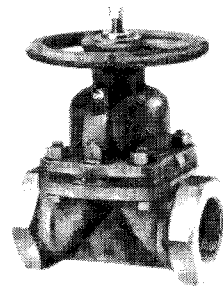

Weir Type
Threaded
536101

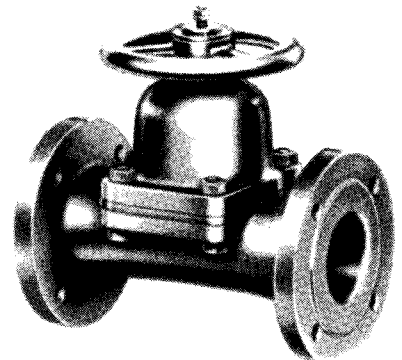

Straight/KB Type
Flanged
536301

PRESSURE VACUUM RELIEF VALVES

Type HS high velocity pressure vacuum relief vent, manufactured by Pres Vac provides active protection from fire and explosions and automatically controls the tank pressure/vacuum during loading, discharge, voyage, and ballasting without any manual operation. It provides safe operation regardless of flow volume and can be used in common and individual systems and in inert gas systems. Discharge velocity is constantly 125 m/sec. The type HS is made and tested in accordance with IMO MSC/Circ 373, Rev 0-2 and API Standard 2000 and is approved by leading classification societies.

Features include: simply a single moving part and an automatically closing checklift mechanism much preferred by users and societies. Proper sizing is based on calculation rather than line size, thus insuring system integrity. Constructed in material configurations compatible with any cargo.

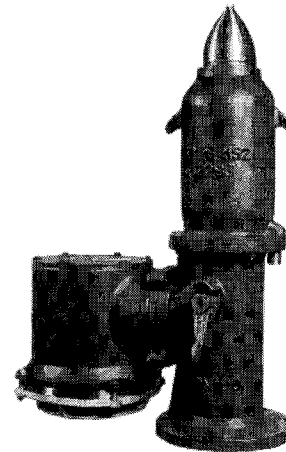

High Velocity
Type HS

Pres Vac overflow protection device Type K spill valve is designed to prevent over-pressurization of tanks due to overfilling which may occur if the high level alarm float is punctured, or warning signals ignored. The Type K provides safe operation by virtue of design with few moving parts, and highest quality standards. It is designed in accordance with ASTM F-1271 and satisfies regulation II-2/59.1.6 of the 1981 and 1983 amendments to SOLAS 1974. To limit vapor leakage it features a flexible sealing system that utilizes the tank pressure to enhance sealing contrary to the opposite effect experienced with o-rings and other traditional sealings. Because of its full-lifting operation, the device generates no additional pressure drop to the set pressure until fully open at which point pressure drop will start to increase.

It is suitable for use with any cargo, and closable for coastal voyages. Sizes 8"/200mm and 10"/250mm.

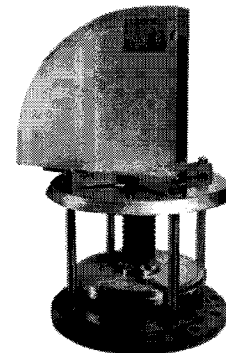

Liquid Overfill
Spill Type
Type K

Type 1500-FLS Pres Vac relief valve, or "breather valve" as it is sometimes called is a weight-loaded end-of-line valve for openings used during cargo operation, ballasting, and voyage "breathing" for pressure equalization. It is a conventional non-full-lifting type and is for use on exclusively vented vessels/common venting systems. Available in IMO certified versions; approved per API 2000 standard. Made in all applicable sizes and standards.

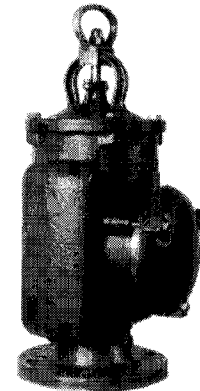

Side Vent
Type 1500-FLS

FLAME SCREENS & ARRESTERS

Designed to prevent passage of flame into cargo tanks. Available in bronze, iron or stainless steel. IMO type test approved as per IMO-MS-Circ. 373. Selection of proper size is based on calculation of pressure drop according to IMO MSC/Circ 450/1. The nominal size of pipeline is secondary to this calculation.



Low & Medium Capacity
Type EPV

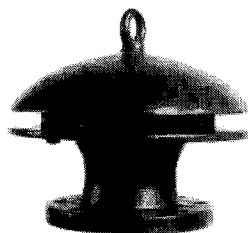

Flame Arrester
Type EP

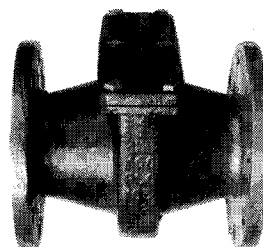

In-Line Flame Arrester
Type PL/PLC

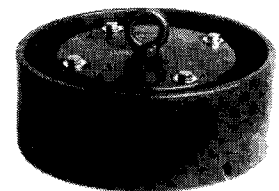

Vertical Discharge Hi Cap
Flame Arrester Type VFA

RELIEF VALVES

DESIGN DESCRIPTION

Relief valves are used for liquid service. They have a fixed lip in the disc which provides increased lift as pressure rises above set pressure. They do not have a huddling chamber. Relief valves start to open at set pressure, but require about 20% over pressure to open fully. As the pressure drops, they start to close and are fully closed as set pressure is reached.

Repairs, testing and certification performed to your requirements.

MATERIALS:

Bronze
Iron
Cast Steel
Stainless Steel

ORDERING INFORMATION:

Material and Size
End Connections (Inlet & Outlet)
Service (Liquid, Oil, other)
Set (to relieve at) Pressure
Capacity at Set Pressure
With or without Lift Lever



Bronze Relief Valves
Stainless Steel on request
Liquid Service

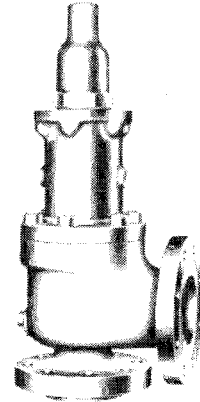

Cast Steel & Iron Relief Valves
Liquid Service



Bronze Safety Valves
Air & Steam Service

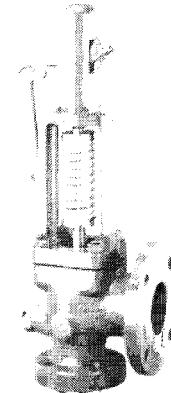

Cast Steel
Safety Valves
High Capacity
Full-Nozzle

SAFETY VALVES

DESIGN DESCRIPTION

Pop safety valves are used for air or steam service. These valves have an adjustable huddling chamber which regulates popping action and the amount of blowdown. Lifting levers and condensate drain holes on the discharge side of the valve are required by ASME Boiler Construction and Unfired Pressure Vessel Codes for all services except when release of noxious or inflammable gases may create a hazard. Pop safety valves function by "popping" wide open at set pressure and remaining in that position until the pressure in the vessel has dropped a predetermined amount (blowback or blowdown). The valves will then snap fully closed.

Repairs, testing and certification performed to your requirements.

MATERIALS:

Bronze
Iron
Cast Steel
Stainless Steel

ORDERING INFORMATION:

Material and Size
End Connections (Inlet & Outlet)
Service (Air, Steam)
Set (to relieve at) Pressure
Capacity at Set Pressure
With or without Lift Lever

TEMPERATURE REGULATORS

Temperature regulators are used to control heating or cooling applications.

Direct acting type are typically used to modulate hot water or steam heating systems. The valve is normally open and closes in response to increase of temperature which is sensed by the bulb.

Reverse acting regulators are used in cooling systems. The valve is normally closed and opens as the temperature sensed by the thermometer bulb increases. The opening valve provides cooling water to the downstream line, tank or heat exchanger.

Temperature regulators are available in two way and three way configurations. Three way are used for mixing or diverting of hot and cold water. End connections are flanged, or union type with threaded or silbrazed tailpiece ends.

For ordering please specify desired temperature range, capillary length, and bulb length.

Combination pressure/temperature regulators are available for heating systems where a maximum pressure limitation is mandatory. To order this type specify both temperature range and pressure setting.

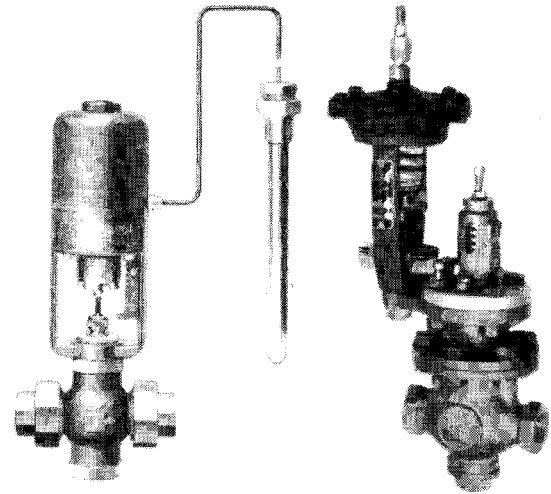

Direct Acting
or
Reverse Acting
Threaded, Union or
Flanged Ends

Combination
Pressure and
Temperature
Regulator
Threaded Ends

PRESSURE WATER VALVE

These valves are for water or salt water cooled condensers and refrigeration systems. Specify refrigerant type, required pressure range, fresh or salt water.

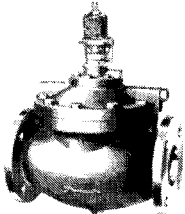

Penn, Marsh, Johnson
Series V43
Pilot Operated
2" to 4"

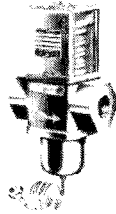

Penn, Johnson
Series V46
w/ Pressure Element
3/8" to 1 1/4"

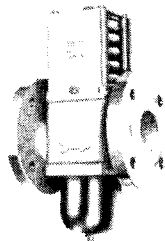

Penn, Johnson
Series V46
w/ Pressure Element
1 1/2" to 2 1/2"

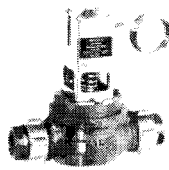

Metrex
WCM 3080
Single or Double
Union End 3/8" to 1"

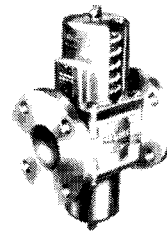

Metrex
DA 866
1/2" to 2 1/2"

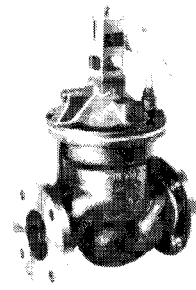

Metrex
MM
2" to 4"

REFRIGERATION VALVES

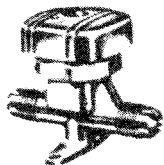

Packless Valve
Globe & Angle
& 3 Way
Solder or Flared Ends

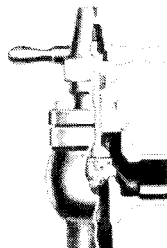

Packed Valves
Globe & Angle
Solder Ends

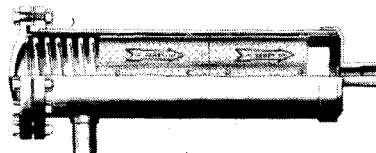

Cartridge
Refrigerant
Drier
Solder Ends

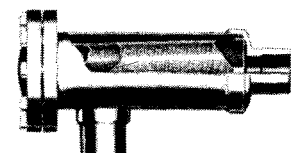

Strainer
Solder Ends

PRESSURE REDUCERS AND REGULATORS

Pressure reducing and regulating valves are available in Bronze, Iron, Steel, or Stainless for reducing downstream pressure of liquid, air, steam, or oil. To order please specify service, inlet pressure and outlet pressure, or pressure range, temperature and capacity, if known.

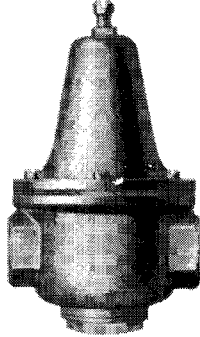

Bronze Reducer
Liquid or Air
300 PSI Max. Inlet
150 PSI Max. Outlet
Threaded Ends
SIZES: 1/2" to 2"

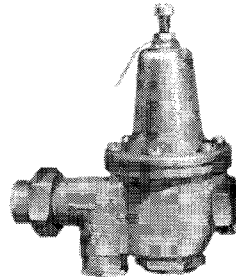

Bronze Reducer
Liquid
with Integral Strainer
300 PSI Max. Inlet
150 PSI Max. Outlet
Threaded Ends
SIZES: 1/2" to 2"

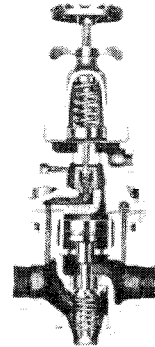

High Performance
Air or Steam
Bronze Body, Stainless Trim
600 PSI Max. Inlet Air
585 PSI Max. Outlet Air
300 PSI Max. Inlet Steam
275 PSI Max. Outlet Steam
Threaded or Flanged Ends
SIZES: 1/2" to 3"

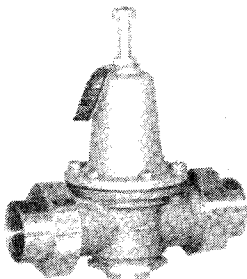

Bronze Reducer
Liquid
300 PSI Max. Inlet
125 PSI Max. Outlet
Union Threaded or Silbrazed Ends
SIZES: 3/4" to 2"

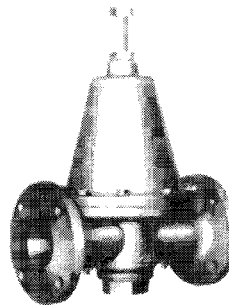

Bronze Reducer
Liquid
300 PSI Max. Inlet
125 PSI Max. Outlet
Flanged Ends
SIZES: 1" to 6"

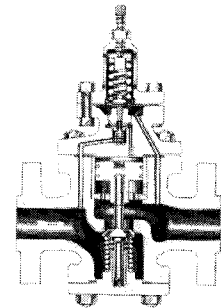

Steel Reducer
Steam
1000 PSI Max. Inlet
400 PSI Max. Outlet
Flanged or Threaded Ends
SIZES: 1/2" to 3"

CONTROL VALVES

Control valves are used to control steam, water or gas in marine and industrial applications. Available in steel, iron, bronze or stainless with flanged, threaded or weld ends. Control valves are diaphragm operated with air supplied to controlling diaphragm from external source. Standard design is straight globe type with balanced double seat. Also available in angle or 3 way pattern.

Direct acting are normally open, providing constant downstream pressure even during large pressure fluctuations.

Reverse acting are normally closed and open in response to air supply to diaphragm, reducing upstream pressure.

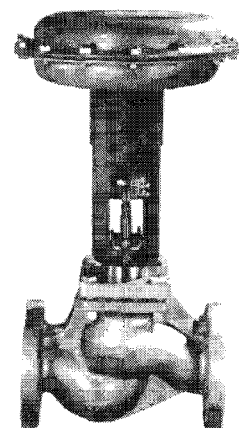

SPECTACLE TYPE

LINE BLIND VALVE

SIZES: 2" to 24"

**Cast Steel or Stainless Steel
Flanged or Buttweld Ends**

The spectacle blind provides positive, permanent shutoff. When the blind end of the spectacle plate is clamped in position, media cannot leak to the downstream side. These valves are especially useful in critical separation of incompatible tank cargos.

The uninstalled end of the spectacle plate is visible outside the valve body, providing a positive visual indication of its open/closed condition.

To operate, simply spread line with using a bar or pipe (pictured) by working cam bolts, then rotate spectacle plate on its pivot and re-tighten. No other tools required.

Replacement spectacles and spectacle O-ring gaskets available.
(Specify type of rubber or teflon).

Steel valves are supplied standard with steel spectacles though stainless spectacle plates are available on request.

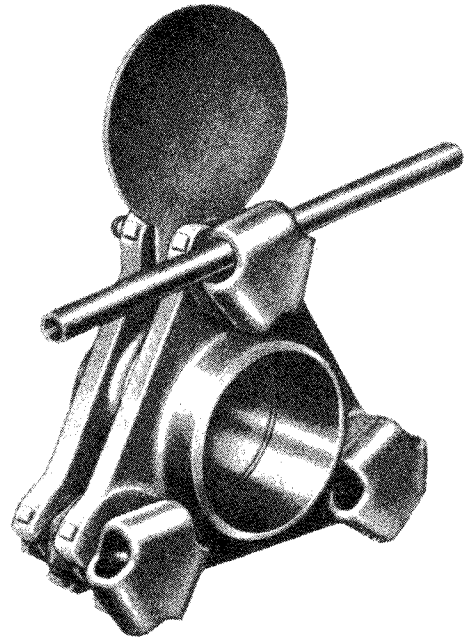

Steel Flanged	506101
Steel Buttweld	506401
Steel Flanged SS Trim	506107
Steel Buttweld SS Trim	506407
Stainless Flanged SS Trim	507107
Stainless Buttweld SS Trim	507407

RIGID TYPE

LINE BLIND VALVE

SIZES 2" to 24"

**Cast Steel or Stainless Steel
Flanged Ends**

The rigid blind also provides positive shutoff for separation of different media or blanking off part of a piping system. Tankers, liquid barges and tank farms are ideal applications.

Double discs, faced with compressed gaskets are expanded against stainless steel seats, ensure leakproof operation and avoid the wear and tear associated with metal to metal seats. Discs are joined by a hexagon-shaped spreader threaded left and right. As the spreader is turned, discs spread against seats. When line is open, discs are stored outside the body, usually in a cradle attached to the piping, visibly indicating open.

Wetted steel parts can be treated with an anti-corrosive epoxy coating for use with oil or seawater. Specific coatings for chemical or other service available on request.

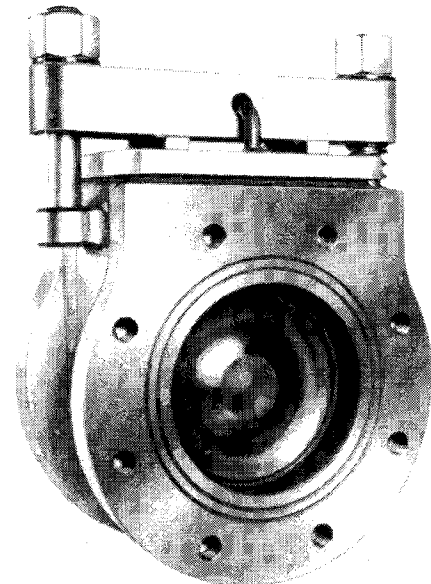

Steel Flanged	506601
Steel Flanged SS Trim	506607
Stainless Flanged SS Trim	507707

CARGO ANGLE VALVES

HIGH LIFT

Unique design features include:

	PIPE SIZE	NO. TURNS TO OPEN	CENTER TO FACE	OVERALL HT OPEN
"High lift" requires fewer turns to raise disc to full open position	4	13	6	20
In open position valve disc is raised out of liquid flow, eliminating vibration	6	14	8 1/4	27
Unobstructed flow	8	21	10 1/2	32
Body shape provides less turbulence and lower hydraulic loss	10	25	13 1/4	39
Faster, more efficient loading and discharge of liquid cargos	12	30	14 1/4	42

Standard construction is cast iron (A-126 Class B) with bronze trim, flanged ends. Also available cast steel or ductile iron.

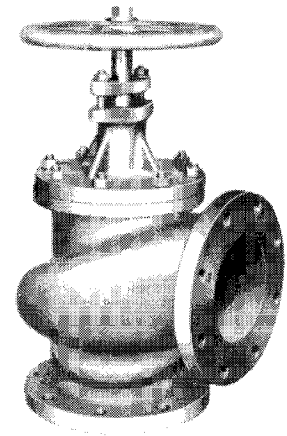

Cargo Angle

CROSS / MANIFOLD

SIZES: 2" to 10"

Cast steel construction
 Bronze or CR13 trim
 Cross valve available in steel or bronze
 Multi-valve simplex manifold available as well as duplex
 In cast steel valve units manifold assembly can be flanged or welded (shown) together

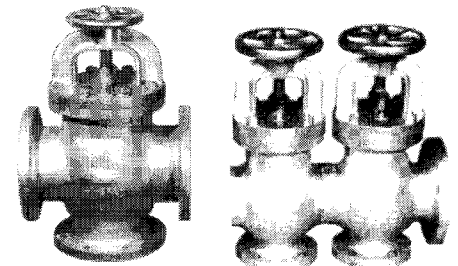

Cross Valve

Simplex Manifold

EDUCTORS

Eductors are used to pump tanks, cargo holds, bilges, or lockers dry. Pressure through inlet creates pumping suction from one side and discharge out the other side. Suction/discharge can be straight through or angle arrangement. Available in bronze with flanged or threaded ends. Specify style, size and end connections of inlet(a), suction(b) and discharge(c).

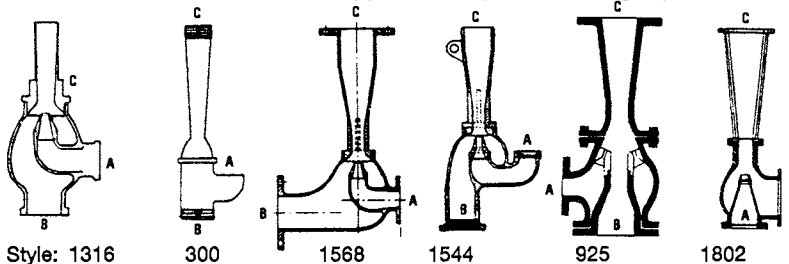

Style: 1316

300

1568

1544

925

1802

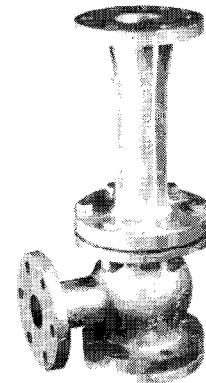

Eductor

SUCTION BELLMOUTH

SIZES: 3" to 20"

Efficient design minimizes hydraulic loss, prevents vortex and gas formation

Permits close "stripping" of liquid cargos

Standard construction is cast steel

Standard design has beveled end for welding connection

PIPE SIZE	HEIGHT	LENGTH	WIDTH
3	5	11 3/4	5 1/2
4	6 3/4	15 1/4	6 3/4
5	8 3/8	19 1/4	8 1/4
6	10	23 1/4	10
8	13 3/8	30 3/4	13 3/4
10	16 3/4	39	16 3/4
12	20	45 3/8	21 3/8

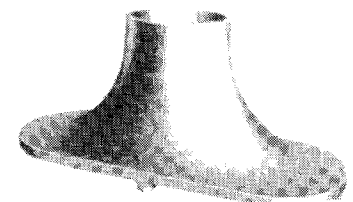

Bellmouth

DECK DRAINS & ACCESS BOXES & COVERS

SIZES: 1/2" to 4"

ECONOMY DECK DRAINS

Steel body for direct welding to steel deck. Strainer plates are furnished in bronze. Buttweld, socketweld, or threaded ends are available. Spare bronze strainer plates available. (Specify diameter).

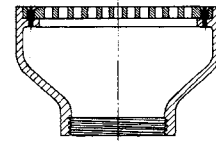
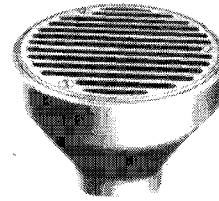

511201 Threaded
511301 Socketweld
511401 Buttweld

HEAVY WALL DECK DRAINS

This series of deck drains has a heavy wall for direct welding to steel deck. Bodies are furnished in steel, galvanized with bronze strainer plates.

Available with or without trap and baffle in straight or angle configurations.

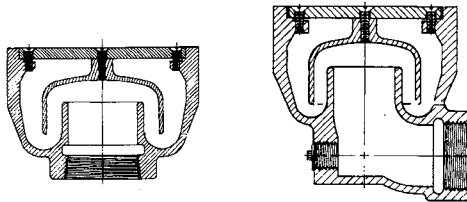
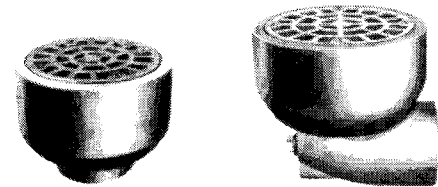

With Trap & Baffle
Angle Type
511502 511602

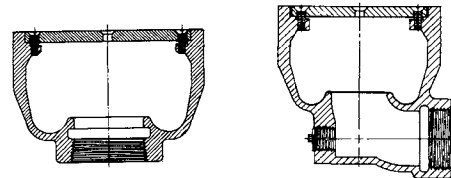

Without Trap & Baffle
Angle Type
511501 511601

DECK ACCESS BOXES

For direct welding to steel deck.

Fig 522101 furnished with heavy wall stainless body and bronze countersunk plug, in sizes 1 1/2" and 2" in either socketweld or buttweld connections.

Fig 522201 has a steel body with bronze plug, available in 1 1/2", 2" and 2 1/2" socketweld or buttweld end connections.

Fig 522301 Steel body access box for reach rod operation.

Fig 522401 Rapid action deck cover in bronze fits standard 12 1/2" deck opening, deck thickness up to 3". Flat, safe top.

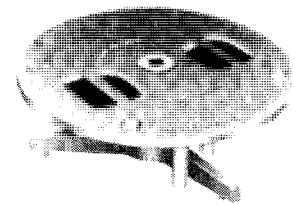

Rapid Action Deck Cover
522401

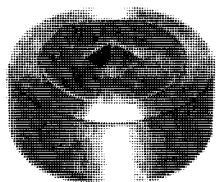

Stainless Body
Square Hole
Brz Plug Diam 2 5/16"
522101

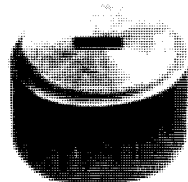

Steel Body
Slotted Hole
Brz Plug Diam 4"
522201

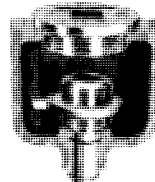

Steel Body
For Remote
Operation
522301



Deck Plug Bronze Countersunk
Square or Slotted
Specify plug diam
and thread diam

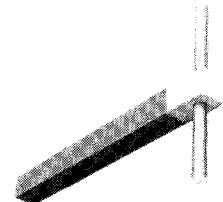

T-Wrench
Steel
Specify Square
or Rectangle
Dimension

INVERTED VENT CHECK VALVE

SIZES: 1" to 12"

Cast Iron, Cast Steel or Bronze Body
Copper, Monel or PVC Float Ball
Threaded, Flanged, Buttweld or Silbrazed Ends

Inverted vent check valves protect tanks and bulkheads from vacuum and pressure build-up during loading and unloading of liquid or dry cargo, and assure maximum efficiency during pumping operations. The ball float prevents contamination of tank cargos by saltwater during heavy seas. The fine monel flame screen isolates flammable fluids and dry cargo dust from deck fires. A protective mesh covers this flame screen and protects it from damage.

Replacement balls are available in copper, monel or PVC. Specify valve size or ball diameter.

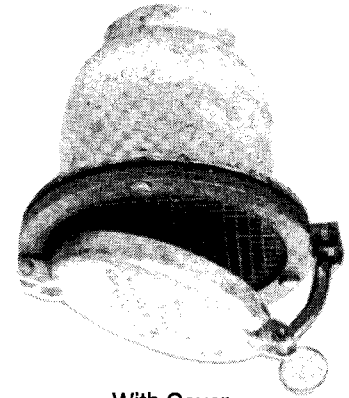

With Cover

	WITHOUT COVER	WITH COVER
Thread	521104	521101
Silbrazed	521105	—
Buttweld	—	521102
Flanged	521106	521103

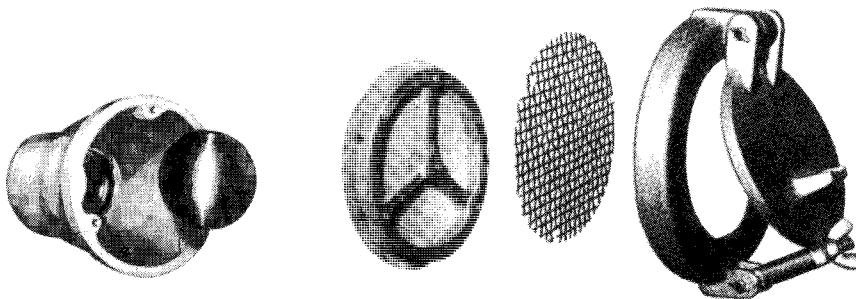

Body Ball Flame Screen Float Support Protective Mesh Cover

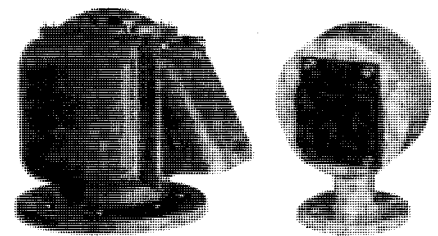

Vertical Type M4
521902 Steel
521803 Bronze

Vertical Type W
521901 Steel
521802 Bronze

TANK AIR ESCAPE VALVES VENT TERMINALS

SIZES: 1" to 12"

Cast Iron, Cast Steel or Bronze Body
Threaded, Flanged, Buttweld or Sil-Braze Ends

Tank air escape valves permit the free passage of air into tanks, dry cargo holds, or storage spaces, and prevent vacuum or pressure build-up during pumping operations. These valves have no automatic means of closing and should not be used in locations accessible to seawater. The fine monel flame screen isolates flammable fluids and dry cargo dust from deck fires. It also prevents the entrance of insects into cargo areas. Although similar in design to inverted vent checks, vent terminals are not equipped with a ball float.

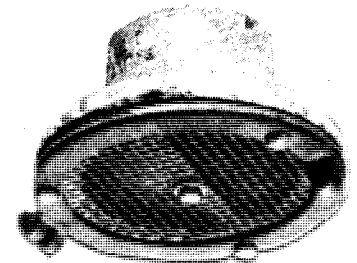

Without Cover

	WITHOUT COVER	WITH COVER
	Bronze	Steel, Iron
Thread	521204	521201
Silbrazed	521205	—
Buttweld	—	521202
Flanged	521206	521203

HOSE CAPS, FITTINGS AND ADAPTERS

To order specify type of hose thread - see thread dimension chart on the following page.



Hose Cap
Pin Lug



Hose Cap
Rocker Lug



Hose Cap
Hex



Hose Cap
Slotted



Hose Plug



Hose Adapter
Male x Male



Hose Adapter
Male x Female



Hose Adapter
Female x Female



Hose Adapter
F. Silbrazex Hose

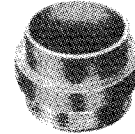

Hose Adapter
M. Silbrazex Hose



Swivel Adapter
Male x Female



Swivel Adapter
Female x Female



Storz Coupling
MPT, FPT, Shank

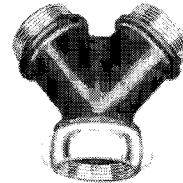

Siamese
Wye



Siamese Wye
Plug Valve



Hose Flange
Female



Hose Flange
Male

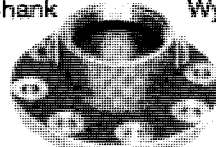

Hose Flange
Swivel



International
Shore Connection
Flange

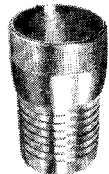

Combination
King
Nipple

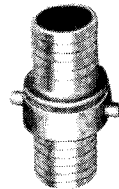

Hose
Shank
Coupling

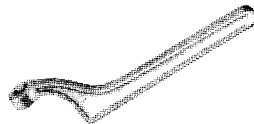

Spanner
Wrench
Pin or Rocker Lug

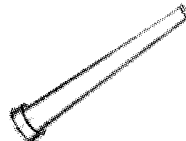

Nozzle

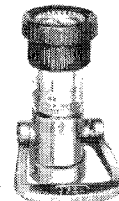

Fog Foam
Nozzle

CAMLOCK FITTINGS

SIZES: 1/2" to 12"

MATERIAL: Brass, Aluminum, Stainless



Part A
Male Adapter
Female Thread

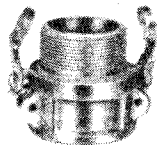

Part B
Female Coupler
Male Thread

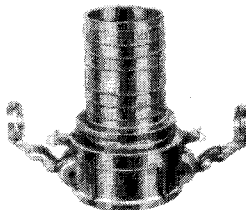

Part C
Female Coupler
Hose Shank

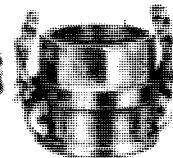

Part D
Female Coupler
Female Thread



Part E
Male Adapter
Hose Shank



Part F
Male Adapter
Male Thread



Dust
Plug
Adapter

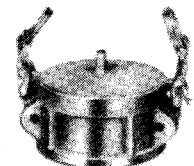

Dust
Cap
Coupler

HOSE VALVES

SIZES: 1/2" to 2 1/2" and 15mm to 65mm

Bronze body and trim (Monel trim available)
 Rubber disc washer on globes and angles
 Available with NH or NPSH outlet (chart below) cap supplied separately
 Inlet IPS female threaded (FPT) or flanged to
 ANSI 150 or 300, JIS 5K or 10K or DIN PN10.

See page 22 for JIS and DIN metric hose valves.

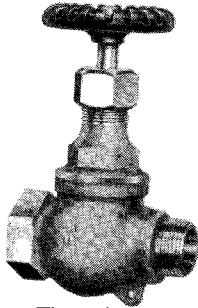

Threaded
Hose Globe
NH 122382
NPSH122392

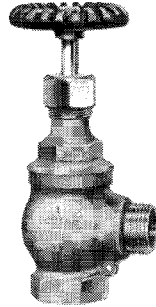

Threaded
Hose Angle
NH 122482
NPSH 122492

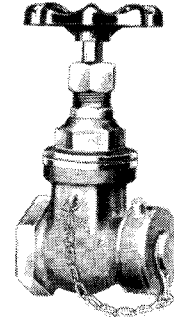

Threaded
Hose Gate
NH 122182
NPSH 122192

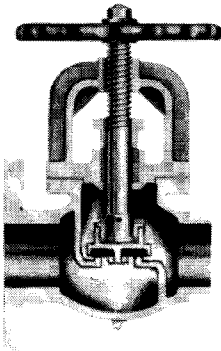

Flanged
Hose Globe
150 LB NH 055303
150 LB NPSH 055301
300 LB NH 055333
300 LB NPSH 055331
5K JIS see
10K JIS page
PN10 DIN 22

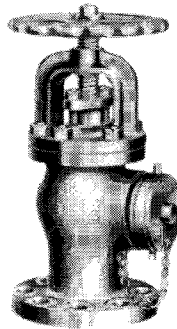

Flanged
Hose Angle
150 LB NH 055403
150 LB NPSH 055401
300 LB NH 055433
300 LB NPSH 055431
5K JIS see
10K JIS page
PN10 DIN 22

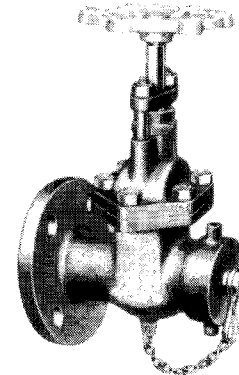

Flanged
Hose Gate
150 LB NH 055103
150 LB NPSH 055101

THREAD DIMENSION CHART

	Outside Diameter			
	NH (NST)	NPSH (SIPT)	GHT	NAVY
1/2	-	.825	-	-
3/4	-	1.035	1.063	1.035
1	1.375	1.295	-	1.295
1 1/4	1.672	1.640	-	1.640
1 1/2	1.990	1.875	-	1.875
2	2.516	2.345	-	2.345
2 1/2	3.069	2.841	-	3.069

	Threads per inch			
	NH (NST)	NPSH (SIPT)	GHT	NAVY
1/2	-	14	-	-
3/4	-	14	11 1/2	14
1	8	11 1/2	-	11 1/2
1 1/4	9	11 1/2	-	11 1/2
1 1/2	9	11 1/2	-	11 1/2
2	8	11 1/2	-	11 1/2
2 1/2	7 1/2	8	-	7 1/2

NH = National Hose
 NST = National Standard Hose
 NPSH = National Pipe Standard Hose
 SIPT = Straight Iron Pipe Thread
 GHT = Garden Hose Thread
 NAVY = U.S. Navy Hose

STEAM TRAPS

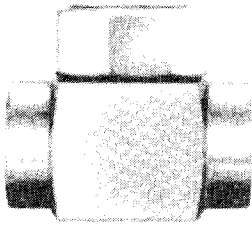

Thermodynamic TD-52
 Stainless Construction
 Max. pressure 600 PSI / 800° F
 Threaded or Socketweld
 Sizes 3/8" to 1"
 Fig. 531101 - Threaded
 Fig. 531103 - Socketweld

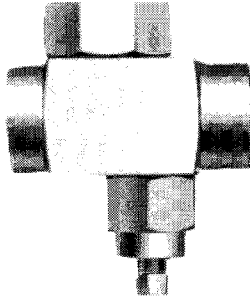

Thermodynamic TD-S-52
 with Integral Strainer
 Max. Pressure 600 PSI / 800° F
 Threaded Ends
 Sizes 1/2" to 1"
 Fig. 531102 - Threaded

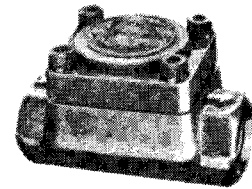

Impulse 40 Series
 Heavy Condensate Load
 Max. Pressure 600 PSI / 750°
 Threaded or Socketweld
 Sizes 1/2" to 3"
 Fig. 531108 - Threaded
 Fig. 531109 - Socketweld

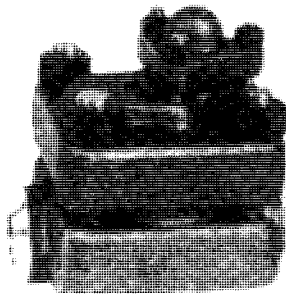

Thermodynamic High Pressure
 High Temperature
 Chromemoly Body
 Max Pressure 1500 PSI
 Max. Temperature 1000° F
 Socketweld Ends
 Sizes 1/2" to 1 1/2"
 Fig. 531104 - 600 LB
 Fig. 531105 - 1500 LB

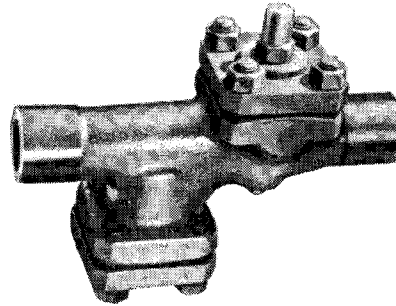

Thermodynamic High Pressure
 High Temperature
 Chromemoly Body
 Max. Pressure 1500 PSI
 Max. Temperature 1000° F
 Socketweld Ends
 Sizes 1/2" to 1 1/2"
 Fig. 531101 - 600 LB
 Fig. 531107 - 1500 LB

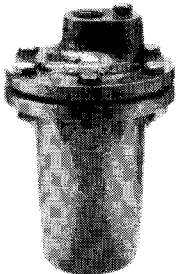

Inverted Bucket Trap
 Iron Threaded (Stainless available)
 Max. Pressure 250 PSI / 450° F
 Inexpensive, high capacity traps. Non-continuous condensate discharge durable design is water hammer resistant. Limited air venting capacity
 Sizes 1/2" to 2"
 531201-Side in & out Add SS for SS
 531202-Top in, Bottom out

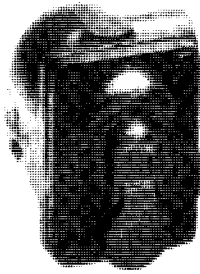

Float/Thermostatic
 Iron Threaded
 Max Pressure 125 PSI / 350° F
 Fast acting with continuous discharge of condensate, high air venting capacity
 Sizes 1/2" to 2"
 531301

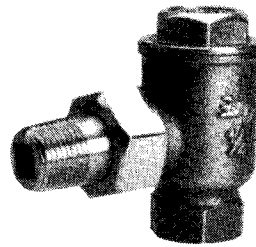

Thermostatic
 Bronze Threaded
 Max. Pressure 125 PSI
 Bellows Operated
 Used on Radiators and Heating Units.
 Straight or Angle
 Sizes 1/2" to 3/4"
 Angle-531502
 Straight-531501

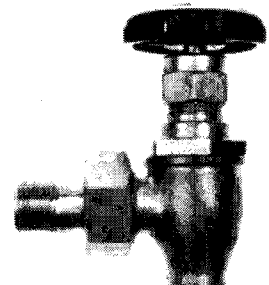

Radiator Valve
 Bronze Threaded
 150 PSI
 Angle or Straight
 Sizes 1/2" to 1"
 Angle-531601
 Straight-531701

STRAINERS

SIZES: 1/4" to 12"

All types made with flanged, threaded or socket ends
 Metric DIN/JIS flanged - add "mm" to part # indicate standard
 Specify perforation or mesh size of basket**

PARTS AND MATERIALS CHOICES

BODY	BASKET	ENDS
Bronze	Bronze	Threaded
Iron	Stainless steel	Flanged
Steel	Monel	Socketweld
Stainless steel		Silbraze/sweat
		Solder joint

"Y" TYPE STRAINERS are generally used where the need for cleaning is infrequent. "Y" strainers must be installed with the basket down. The screen or basket is removed from the bottom. Suitable for use in vertical lines.

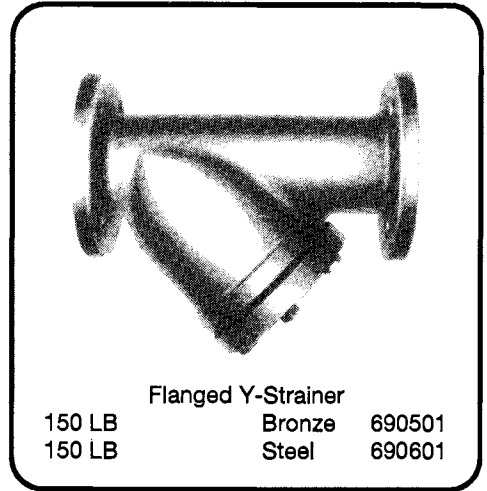

Flanged Y-Strainer
 150 LB Bronze 690501
 150 LB Steel 690601

125 LB Iron 690600
 250 LB Iron 690602
 300 LB Steel 690603
 600 LB Steel 690606
 150 LB Stainless 690701

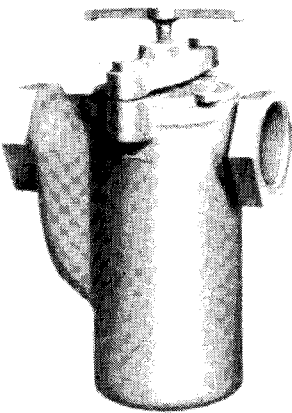

**THREADED
 SIMPLEX BASKET STRAINER**
 150 LB Bronze - 691501
 150 LB Steel - 691601
 125 LB Iron - 691801

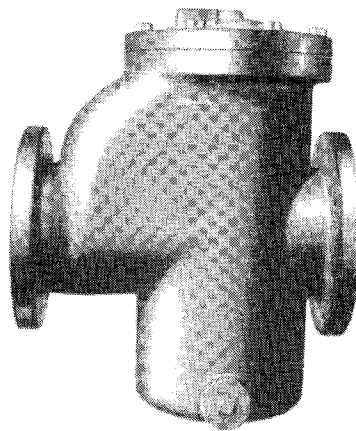

**FLANGED HIGH CAPACITY
 SIMPLEX BASKET STRAINER**
 150 LB Bronze - 691501HC
 150 LB Steel - 691601HC
 125 LB Iron - 691801HC

BASKET or SIMPLEX STRAINERS are used where frequent cleaning is necessary. A basket strainer is installed upright and the basket is lifted out through the top. The basket has a closed bottom and will trap all material being strained. Available with bolted or yoke type cover, please specify.

DUPLEX STRAINERS are used where uninterrupted service is necessary and the system cannot be shut down to clean the strainer. This type of strainer can operate continuously and never has to be shut down for cleaning. This strainer has two baskets. The flow passes through one basket while the other basket is closed. When one basket becomes clogged and requires cleaning, the flow is transferred to the other basket by turning a lever or handwheel. During this switching operation the flow continues at an uninterrupted rate because one side is opening as the other side closes. Available with bolted or yoke type cover, please specify, if important.

**See page 119 for perforated metal and screen information.

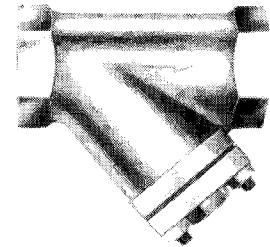

Bronze Silbraze 690101
 Bronze Threaded 690102
 Iron Threaded 690201
 Steel Threaded 690301
 Steel Socketweld 600 LB 690302
 Steel Socketweld 1500 LB 690303
 Steel Socketweld 2500 LB 690304
 Stainless Threaded 690307
 Stainless Socketweld 690337

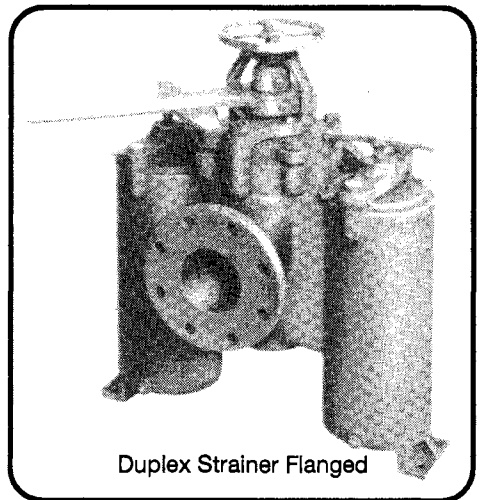

Duplex Strainer Flanged
 150 LB Bronze 692501
 150 LB Steel 692601
 125 LB Iron 692600

BAR STOCK NEEDLE VALVES

SIZES: 1/8" to 1"

200 to 10,000 PSI
CARBON STEEL, STAINLESS, OR BRONZE
THREADED OR SOCKETWELD

Bar stock needle valve are designed for orifice meters, gauges, by-passes, instrument lines, and many other small, high pressure gas and liquid lines requiring fine regulation of flow and compact shape.

Bar stock needle valves come in straight globe or angle patterns. End connections are available with different end combinations, including male by female.

Pressure ratings vary by manufacturer.

GAGE-TYPE NEEDLE VALVES

SIZES: 1/8" OD to 3/4" OD and 6mm to 12mm OD

Available in bronze, stainless steel, and monel. Compact body design, easy to install in space-restricted locations. Made in OD sizes with compression ends, also available with flare ends and male or female, straight or tapered threads. Angle pattern and multiport cross type also available.

PRESSURE GAUGES & THERMOMETERS

Back and bottom connected and adjustable types.
Specify details and scale range.

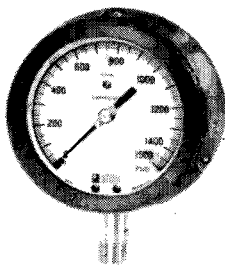

Simplex
Gauge

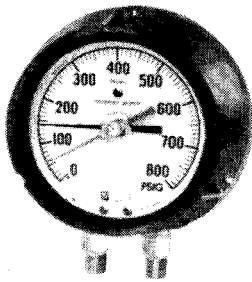

Duplex
Gauge &
Differential
Gauge



Bi-Metal
Thermometer

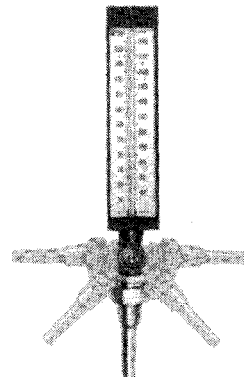

Adjustable
Mercury

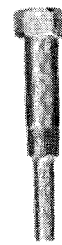

Thermowells
All materials

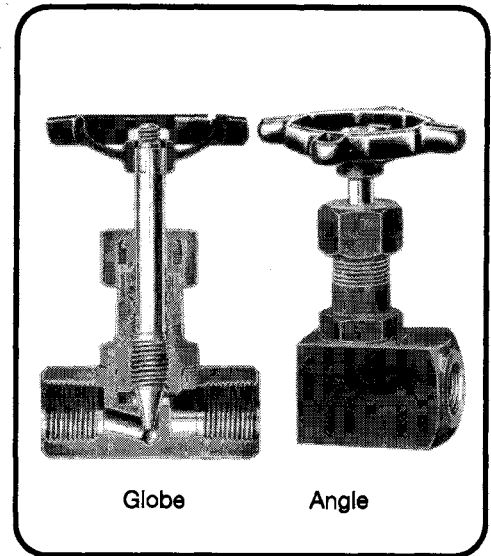

Globe

Angle

	Globe	Angle
Steel Threaded	533601	534601
Steel Socketweld	533631	534631
Stainless Threaded	533701	534701
Stainless Socketweld	533731	534731
Bronze Threaded	533501	534501

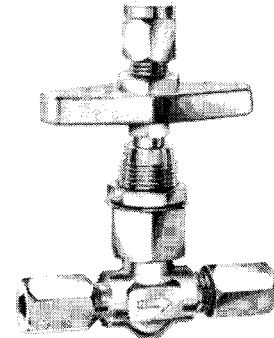

Gage Valves

Stainless	- 533101
Monel	- 533201
Bronze	- 533301

SIGHT FEED VALVES AND FUNNELS

Sight feed valves are used to control oil feeding to bearings. These valves are equipped with needle control and clear glass view piece.

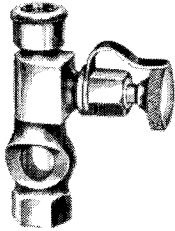

Sight Feed Valve
Bronze Straight
Light Pattern
Sizes 1/8" to 3/8"

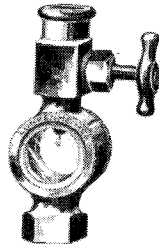

Sight Feed Valve
Bronze Straight
Heavy Pattern
Sizes 1/4" to 1/2"

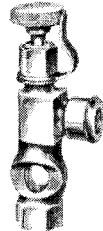

Sight Feed Valve
Bronze Angle
Light Pattern
Sizes 1/8" to 3/8"

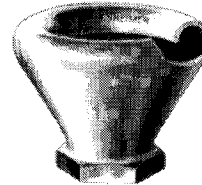

Funnel
Bronze
Threaded
Sizes 1/4" to 3"

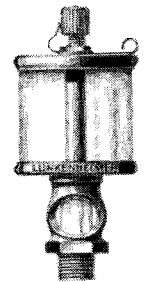

Sight Feed Oiler
Bronze
Threaded
Sizes 1/8" to 3/4"

BOILER AND LIQUID GAUGE VALVES

Indicate liquid levels in boilers or tanks. Automatic type have ball check: closes valve if glass breaks. Non-automatic type do not do this. With 1/2" or 3/4" threaded, or ends flanged, in bronze, steel, high pressure steel offset styles, or stainless.

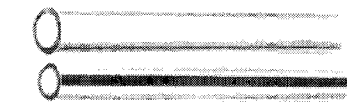

Clear

Redline



Obs. Round



H.P. Flat Clear

H.P. Flat Grooved/Reflex



Flat Insert
Glass Gauge

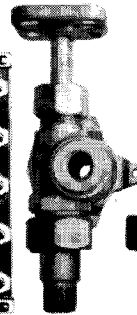

H.P. Steel
Boiler

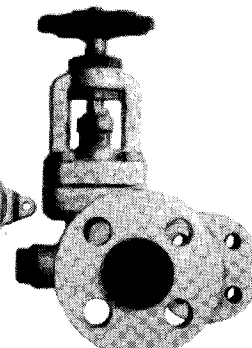

H.P. Offset
Boiler

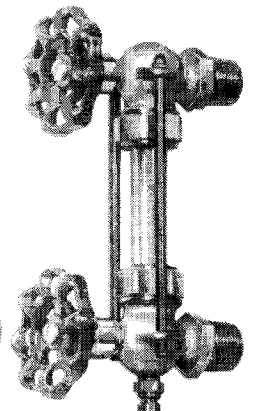

Liquid Gauge
Brz, Steel, SS

Replacement clear and redline glass is available - specify diameter and length.

High pressure glass also: observation rounds and flat clear or grooved/reflex 15/16" wide x 11/16" thick. Specify length. Asbestos & teflon gaskets & mica sheets.

SIGHT FLOW INDICATOR

Sight flow indicators or drip tubes provide visible evidence of flow. Available in all sizes and common materials: Bronze, Steel or Stainless with Threaded, Socket, Braze, or Flanged ends.



Flapper Type
For Horizontal or
Vertical Upward Flow
Also good for Gases

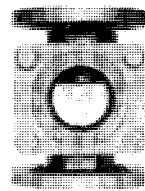

Drip Type
For Vertical
Downward Flow
of Liquids

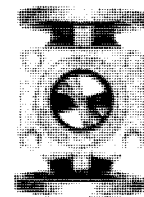

Rotary Type
For Installation
In any Position
Liquids or Gases

QUICK OPEN VALVES

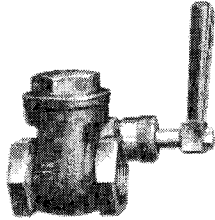

Quick Open / Manual Close
Bronze Threaded
Gate
Drain or Vent Service
Sizes 1/2" to 4"
112150

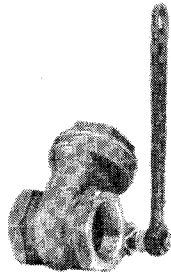

Quick Open / Self Close
Bronze Threaded
Gate
Spring Return Lever
Sizes 1/2" to 4"
112151

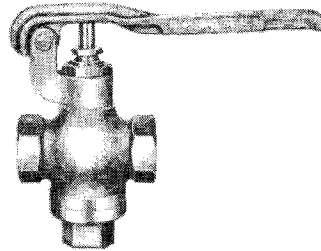

Quick Open / Self Close
Bronze Threaded
Globe
Air or Whistle Service
Sizes 1/4" to 2 1/2"
112351

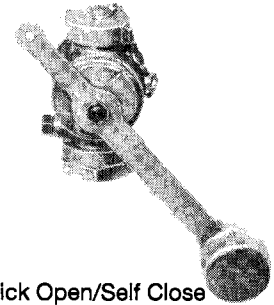

Quick Open/Self Close
Bronze Threaded
Sounding Cock
Tank Service
Sizes 1/2" to 2" BSP
112951

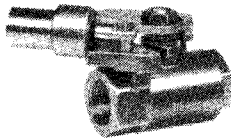

Quick Open / Self Close
Bronze, Steel or Stainless
Ball Valve
"Dead Man" Spring Return Lever
375101 DMSR
376101 DMSR
377101 DMSR

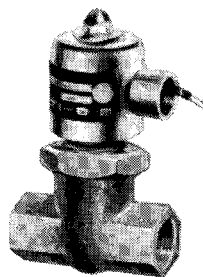

Solenoid
Brass, Stainless
2, 3 or 4 Way
Sizes 3/8" to 2"
Specify voltage, pressure
media, normally open or closed
507101

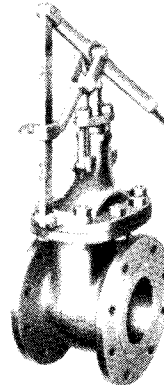

Quick Open / Manual Close
Iron, Steel or Stainless
Gate
Sizes 1/2" to 12"
125 Flanged Iron 021103QO
150 Flanged Steel 012101QO
150 Flanged Stainless 072107QO

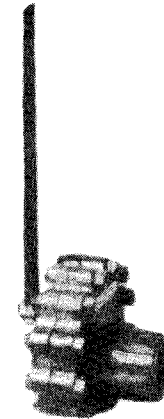

Quick Open / Self Close
Iron or Steel
Boiler Blowdown Valve
Sizes 1/2" to 2 1/2"
250 Threaded Iron 219981
300 Threaded Steel 219991
Flanged End add "Flgd" suffix

EMERGENCY SHUT-OFF QUICK CLOSE VALVES

SIZES: 1/2" to 6" and 15mm to 150mm

These quick closing valves are used on fuel lines to provide control of critical fluid loss. Normally open, the valve is closed by trip wire or hydraulic, pneumatic line or fusible element. Flanged valves are available in cast steel or iron in straight-through globe or angle configuration.

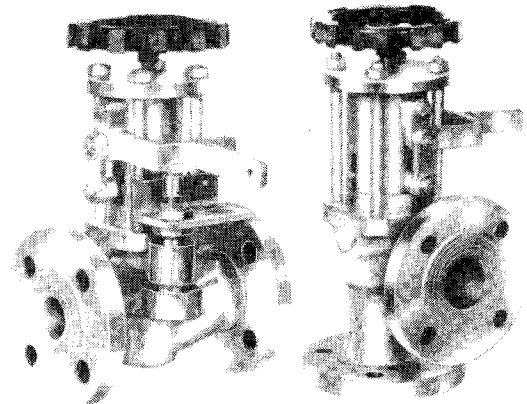

Globe
Iron 982303
Steel 981301

Angle
Iron 982403
Steel 981401

SCUPPER VALVES

SIZES: 2" to 8"

DESIGN DESCRIPTION

Used on overboard discharge lines
 Also called discharge check or storm valves
 All bronze construction or cast steel with bronze trim
 150 lb commercial ANSI, Navy or metric flange drilling
 Available with or without gag control - Please specify

180° FLANGED

	With Control		No Control	
outlet and inlet same size	515071	Bronze	515070	Bronze
	516071	Steel	516070	Steel
outlet larger than inlet	515051	Bronze	515050	Bronze
	516051	Steel	516050	Steel

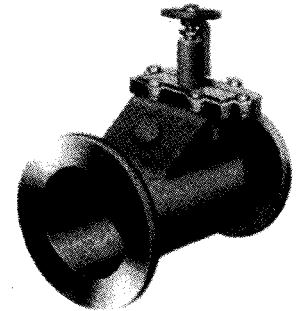

180° With Control

90° FLANGED

	With Control		No Control	
outlet and inlet same size	515081	Bronze	515080	Bronze
	516081	Steel	516080	Steel
outlet larger than inlet	515061	Bronze	515060	Bronze
	516061	Steel	516060	Steel

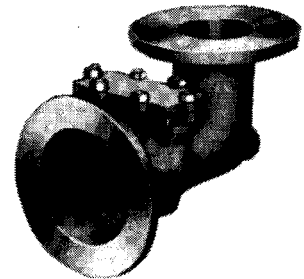

90° Without Control

METRIC STORM VALVE - HORIZONTAL TYPE

	With Control		No Control	
DIN outlet and inlet	995071	Bronze	995070	Bronze
	996071	Steel	996070	Steel
JIS outlet and inlet	946071	Steel	946070	Steel

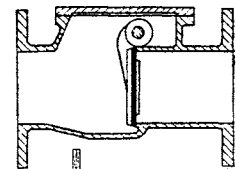

METRIC STORM VALVE - ANGLE TYPE

	With Control		No Control	
DIN outlet and inlet	995081	Bronze	995080	Bronze
	996081	Steel	996080	Steel
JIS outlet and inlet	949081	Steel	946080	Steel

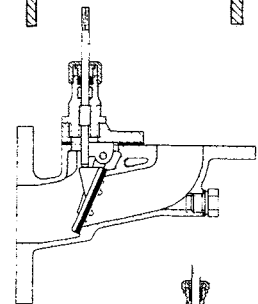

METRIC STORM VALVE - VERTICAL TYPE

	With Control		No Control	
DIN outlet and inlet	995091	Bronze	995090	Bronze
	996091	Steel	996090	Steel
JIS outlet and inlet	946091	Steel	946090	Steel

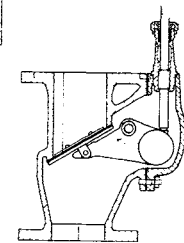

METRIC STORM VALVE - SPRING LOADED

	Globe		Angle	
DIN outlet and inlet	995075	Bronze	995085	Bronze
	996075	Steel	996085	Steel

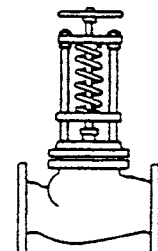

PUBLIC HEALTH VALVES

A general description of product group for potable water system devices often recommended by U.S. Public Health Services in shipboard application. They function as line vacuum breakers and backflow preventers and may be recognized by the numbers shown. Chrome plated pipe, tube, wall standoff pieces, and fittings available: pages 110-111, 87, 90, 101 respectively.

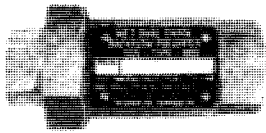

SERIES 7
Dual check backflow preventer with two independent check mechanisms.
Bronze.
Size: 1/2" to 1 1/4" FPT

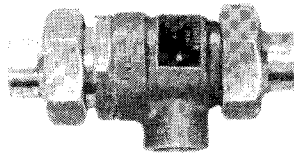

9D (FPT) & #9 DS (Solder)
Backflow prevention with intermediate atmospheric vent. Fig #538009D, DS or C
Size: 1/2" & 3/4" FPT or Tube Solder end.
Brass. Chrome #9 DC & #9 DSC



SERIES 288A (Brass)
Anti-siphon vacuum breaker,
#288AC Chrome Fig #538288A or AC
Size: 1/4" to 3" FPT



NLF 9
Lab faucet vacuum breaker
chrome finish
Size: 3/8" M x F



N9
Backflow preventer with vent
Brass. Chrome # N9C
Size: 1/4" & 3/8" FPT



SERIES 8
Brass body vacuum breaker attaches to hose thread faucet
Size: 3/4" M x F Hose Thread.
8C- same with chrome plating
S8C-same, chrome for spray set use

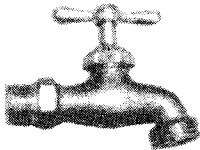

Hose Bibb
1/2" or 3/4" MPT inlet with
3/4" Hose thread outlet. Brass,
chrome plated or stainless steel.

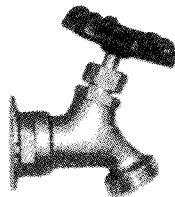

Sillcock utility faucet
1/2" or 3/4" FPT inlet with
3/4" Garden hose outlet

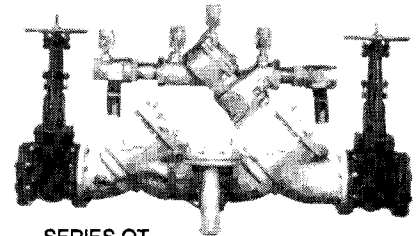

SERIES QT
Backflow preventers
Reduced pressure zone.
Bronze threaded or iron flanged.

MISC BRONZE VALVES

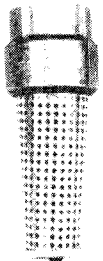

Foot Check Valve
Bronze Threaded
Sizes 1/2" to 3"
520101



**Inline Check
Bronze Threaded
Metal Seat Series 300**
Sizes: 1/2" to 3"
538300

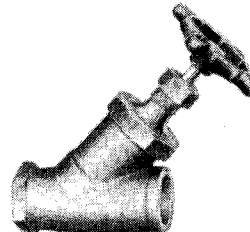

**Inline Check
Bronze Threaded
Buna Seat Series 400**
Sizes: 1/2" to 3"
538400

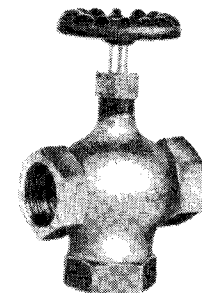

Y-Globe
Bronze Threaded
Sizes: 1/2" to 3"
112901

Cross Valve
Bronze Threaded
Sizes: 1/2" to 2"
112804

FLUSH VALVES

SLOAN DOLPHIN

Hydraulic type flush valve for marine use standard with 1" IPS angle Control stop inlet 1 1/2" outlet for top spud connection on closet model. (Fig. 110XYV). 3/4" Inlet and Outlet on urinal model (Fig 186).

REPAIR KITS:

DO-32-AA Code 0337136, includes O-rings, seals and flex-sac assembly
 DO-32-AAN Code 0337137, includes all rubber rings, seals, flex-sac and seat assembly and springs.
 Code 3337035 repair kit for new style handle

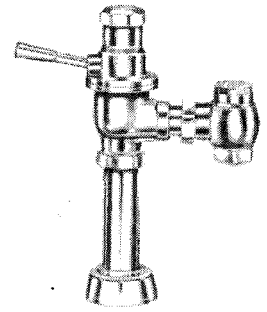

SLOAN CROWN / NAVAL

Piston type flush valve for marine use. Standard with 1" with IPS angle Control stop inlet, 1 1/2" outlet for top spud connection on closet model. 3/4" inlet and outlet on urinal model.

REPAIR KITS:

NCR-60-AC closet piston assembly. Code 0314016.
 NCR-60-AU urinal piston assembly. Code 0314017.
 NB-50-A handle repair kit. Code 5302305.
 S-185 closet or urinal repair kit. Code 5319185.

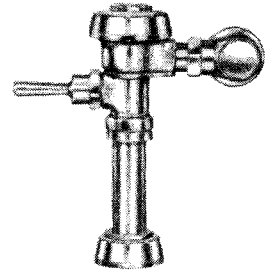

DELANY CUTLASS

Dashpot operated flush valve for marine use. Standard with 1" IPS angle Control stop inlet, 1 1/2" outlet for top spud connection on closet model.

REPAIR KITS:

C825A - internal assembly pieces (11).

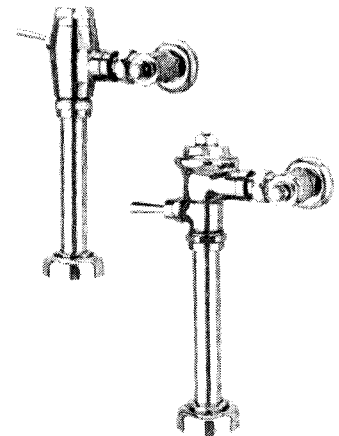

DELANY MARINE

Diaphragm type flush valve for marine use. Standard with 1" IPS angle Control stop inlet, 1 1/2" outlet for top spud connection on closet model.

REPAIR KITS:

M107AC - closet kit
 M107AU - urinal kit

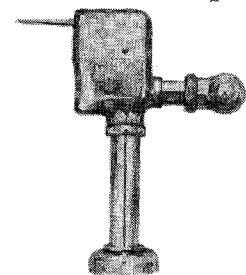

MARCHANT

Hydraulic type flush valve has only a spring loaded bellows in contact with water, Standard with 1" IPS inlet and 1 1/2" outlet.

Specify with or without screwdriver angle Control stop and size and type of inlet and outlet attachment.

REPAIR KIT: MFV-KI

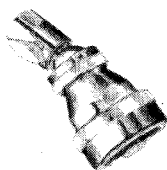

Heavy Duty
Shower Head
AC-51



Economy
Shower
Head

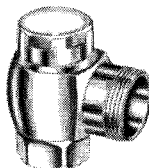

Angle
Control
Stop

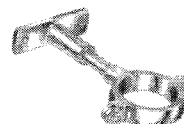

Wall Stand-off
Chrome Fittings (pg 90, 101)
Plated Tube & Pipe (110-111)

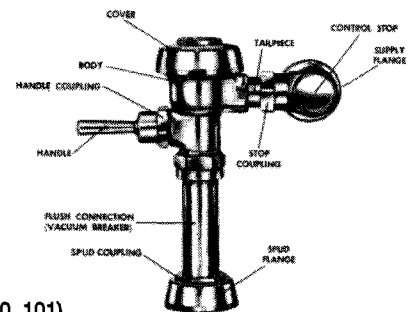

Typical Flush Valve

FASTENERS

Steel
 Heat Treated Steel B7 & 2H (nuts)
 Stainless 304 & 316
 Brass & Bronze
 Plated Zinc
 Galvanized
 Metric

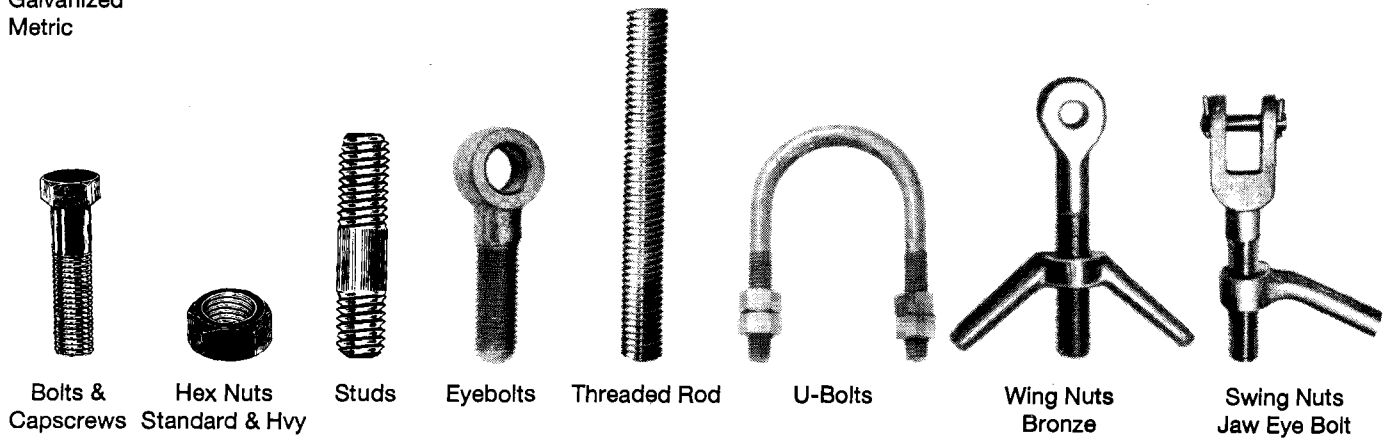

Bolts & Capscrews Hex Nuts Standard & Hvy Studs Eyebolts Threaded Rod U-Bolts Wing Nuts Bronze Swing Nuts Jaw Eye Bolt

MARINE EQUIPMENT

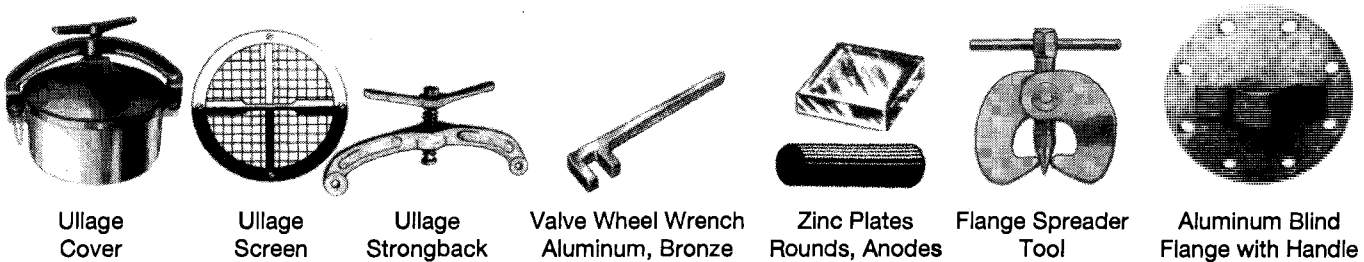

Ullage Cover Ullage Screen Ullage Strongback Valve Wheel Wrench Aluminum, Bronze Zinc Plates Rounds, Anodes Flange Spreader Tool Aluminum Blind Flange with Handle

GASKETS & PACKING

Common types and materials for standard and high pressure, high temperature and steam service.

Red Rubber
 Black Neoprene
 Compressed Non-asbestos
 Vegetable Fiber
 Spiral Wound
 Teflon
 Graphite

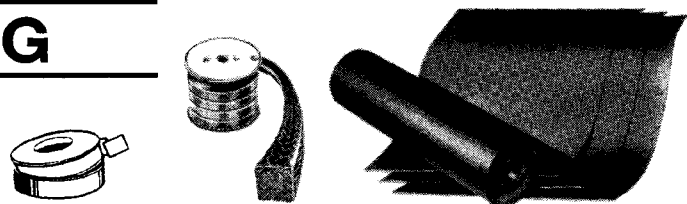

Teflon Tape Braided Packing Fiber & Metallic Sheet Packing & Gasketing



Ring Gasket Full Face Gasket Spiral Wound "Flexitallic®" Flange Insulation Kit Gasket/Bolt Prepackaged Flange Kit



Casting pour into single-use two-part sand molds. Sand is hardened around pattern and core pieces which form the cavities in the casting. Metal can be melted in an induction furnace by a powerful alternating current that circulates around the mass of metal, exciting and thereby heating the molecules to the point of becoming molten.



S.S. United States built 1951-52 at Newport News Shipbuilding and Drydock as Hull 488, with an aluminum superstructure. Length 989.7' (301.7m), beam 101.5' (31m), draft 32' (9.8m), gross tonnage 38216.8 steam turbines generate 173800 shaft horsepower. Taken out of service 1969. At this printing, owned by a Turkish concern and in Russia for asbestos removal.

PIPE FITTINGS

Fittings shown are available in a variety of materials, listed on next page. Figure numbers apply to fitting type.

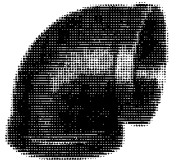

90 Ell
101



45 Ell
104



Tee
121



Coupling
150

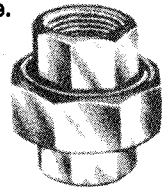

Union
301



Cap
154



Plug
065



Countersunk
Plug
066

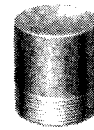

Round Head
Plug
067

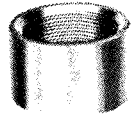

Half
Coupling
149



Reducer
Coupling
150R



Bushing
Insert
157



Face
Bushing
158



Extension
Piece
159



Locknut
046

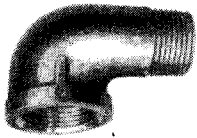

Street
90
107



Street
45
109

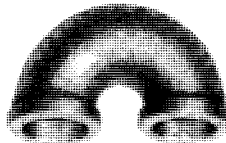

180
Return Bend
156

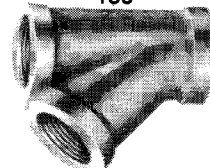

Y-Branch
Lateral
140



Cross
135

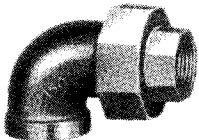

Union
Elbow
530

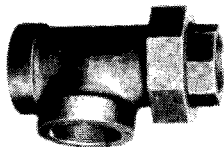

Union
Run Tee
540

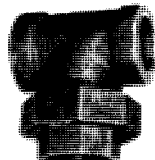

Union
Outlet Tee
545

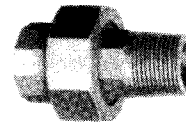

Union
Male x Female
528

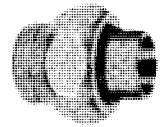

Dielectric
Union
302



Nipple
Thd Both End
9xx



Nipple
T.O.E.
9xx-TOE



Hex
Nipple
800



Swage Nipple
900-SN

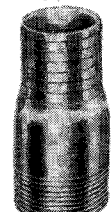

Combination Nipple
700



Companion
(Thd) Flange
170



Floor
Flange
171



Blind
Flange
172

THREADED FITTINGS

High pressure & low pressure fittings in a full range of materials. Sizes: 1/8, 1/4, 3/8, 1/2, 3/4, 1, 1 1/4, 1 1/2, 2, 2 1/2, 3, 3 1/2, 4, 5, 6.

Ordering info: by description or 3 digit material code + 3 digit fitting type code + size

MATERIAL			CODE	FITTING TYPE	CODE		
Bronze Cast B-62/B-61	STD	125LB	603	90 Ell / Reducing	101 / 101R		
	XH	250LB	604	45 Ell	104		
	Chrome Plated	STD	125LB	603C	Tee / Reducing	121 / 121R	
		XH	250LB	604C	Coupling	150	
Malleable Iron-Cast A-197				Reducer Coupling	150R		
	Black	STD	150LB	611	Bushing	157	
		XH	300LB	613	Cap	154	
	Galvanized	STD	150LB	610	Plug	065	
		XH	300LB	612	Countersunk Plug	066	
	Forged Steel A-105		3000LB	621	Roundhead Plug	067	
			6000LB	623	Union	301	
		Galvanized		3000LB	621G	Dielectric Union	302
						Y-Lateral	140
					Cross	135	
				Street 90 Ell	107		
Stainless A-182 (specify 304 or 316)	STD	150LB	650	Street 45 Ell	109		
		3000LB	651	Half Coupling	149		
				1 1/2 Wall Coupling (Alum only)	152		
Aluminum				Flange-Companion	170		
	Alloy 356 cast 6061	STD	150LB	660	Flange-Floor Type	171	
			3000LB	661	Flange-Blind	172	
CopperNickel				Extension Piece	159		
	90/10	3000LB	641	Face Bushing	158		
	70/30	3000LB	646	Locknut	046		
				Return Bend	156		
PVC / CPVC - see page 99				Union Elbow	530		
				Union Run Tee	540		
				Union Outlet Tee	545		
				Union Male x Female	528		



Fittings pictured previous page

Welded Nipple	9xx*
Seamless Nipple	9xx-Smls
Swage Nipple	900-SN
T.O.E. Nipple	9xx-TOE
Hex Nipple	800
Combination Nipple	700

*xx indicates length see page 95 for format and complete listing of nipples.

Thread-by-socket adapter fittings: specify

Metric Threads add suffix:

- BSPT - Tapered British standard thread (JIS B0203, ISO R7, PT)
- BSPP - Straight or parallel, British standard Thread (JIS B0202, ISO R228, PF)

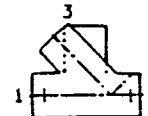

Order reducing tees in 1-2-3 size sequence

SOCKET FITTINGS

High pressure & low pressure fittings in a full range of materials. Sizes: 1/8, 1/4, 3/8, 1/2, 3/4, 1, 1 1/4, 1 1/2, 2, 2 1/2, 3, 3 1/2, 4, 5, 6.

Ordering info: by description or 3 digit material code + 3 digit fitting type code + size

MATERIAL		CODE	FITTING TYPE	CODE
Bronze-Cast B-62/B-61 Silbraze	STD	200LB 605	90 Ell	101
	XH	800LB 606	45 Ell	104
		3000LB 607	Tee	121
Forged Steel A-105			Coupling	150
		3000LB 622	Reducer Coupling	150R
		6000LB 624	Insert (Bushing)	157
		9000LB 626	Cap	154
Stainless A-182 (304/L or 316/L)	TubeOD	652OD	Union	301
	3000LB	652	Y-Lateral	140
Aluminum			Cross	135
	6061 5086	3000LB 662 3000LB 663	Half Coupling	149
Chromemoly Steel			Union Elbow	530
	F11	3000LB 626	Union Run Tee	540
	F22	3000LB 628	Union Outlet Tee	545
	F22	6000LB 629	Union Male x Female	528
CopperNickel	90/10	400LB 640	Reducing fittings: 90, Tee, Lateral Socket x thread adapter fittings: specify	
	90/10	3000LB 642		
	70/30	400LB 645		
	70/30	3000LB 647		
		3000LB 635		

Monel

Copper - see page 102
PVC / CPVC - page 99
Solder Joint - page 102



90 Ell
101



45 Ell
104

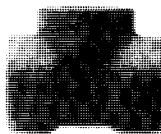

Tee
121



Cross
135

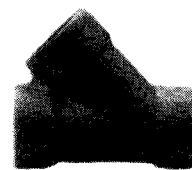

Y-Lateral
140

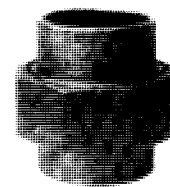

Union
301

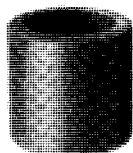

Coupling
150



Reducer
Coupling
150R



Half
Coupling
149



Insert
Bushing
157



Cap
154

WELDING FITTINGS

Dimensions shown cover steel, stainless steel, aluminum, monel and copper nickel (in Sch 40 only: uncommon and costly) but not Class 200/700. Copper nickel in Class 200/700 dimensions, matching common copper nickel pipe wall thicknesses: pg 181, 110.

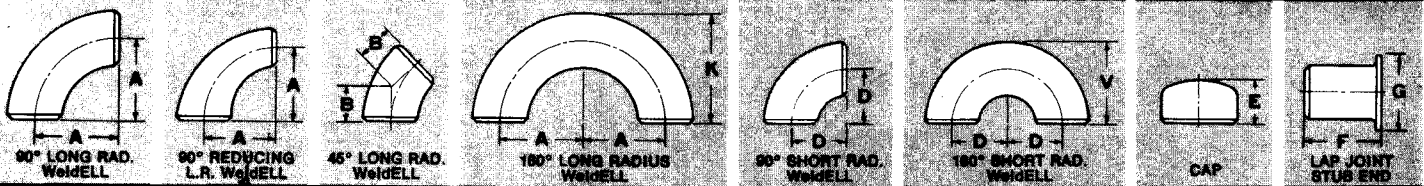

Nom. Pipe Size	Pipe O.D.	WALL THICKNESS														A	B	K	D	V	E	F		G	Nom. Pipe Size
		① Light Wall	Sch 20	Sch 30	② Std	Sch 40	Sch 60	③ X-Stg	Sch 80	Sch 100	Sch 120	Sch 140	Sch 160	Sch 180	XX-Stg							ASA	MSS		
1/2	.840	.083109	.109147	.147188	.294	1 1/2	3/8	1 1/8	1	3	2	1 1/8	1/2	
3/4	1.050	.083113	.113154	.154219	.308	1 1/2	3/8	1 1/8	1	3	2	1 1/8	3/4	
1	1.315	.109133	.133179	.179250	.358	1 1/2	3/8	1 1/8	1 1/2	4	2	2	1	
1 1/4	1.660	.109140	.140191	.191250	.382	1 1/2	1	2 1/8	1 1/4	2 1/8	1 1/2	4	2	2 1/2	1 1/4	
1 1/2	1.900	.109145	.145200	.200281	.400	2 1/4	1 1/8	3 1/8	1 1/2	2 1/8	1 1/2	4	2	2 1/2	1 1/2	
2	2.375	.109154	.154218	.218344	.436	3	1 1/8	4 1/8	2	3 1/8	1 1/2	6	2 1/2	3 1/2	2	
2 1/2	2.875	.120203	.203276	.276375	.552	3 3/4	1 1/8	5 1/8	2 1/2	3 1/8	1 1/2	6	2 1/2	4 1/2	2 1/2	
3	3.500	.120216	.216300	.300438	.600	4 1/2	2	6 1/8	3	4 1/8	2	6	2 1/2	5	3	
3 1/2	4.000	.120226	.226318	.318500	.636	5 1/4	2 1/8	7 1/8	3 1/2	5 1/8	2 1/2	6	3	5 1/2	3 1/2	
4	4.500	.120237	.237337	.337531	.674	6	2 1/2	8 1/8	4	6 1/8	2 1/2	6	3	6 1/8	4	
5	5.563	.134258	.258375	.375625	.750	7 1/2	3 1/8	10 1/8	5	7 1/8	3	8	3	7 1/8	5	
6	6.625	.134280	.280432	.432719	.864	9	3 1/8	12 1/8	6	9 1/8	3 1/2	8	3 1/2	8 1/8	6	
8	8.625	.148	250	.277	.322	.322	.406	.500	.500	.594	.719	.812	.906	.875	12	5	16 1/8	8	12 1/8	4	8	4	10 1/8	8	
10	10.750	.165	250	.307	.365	.365	.500	.500	.594	.719	.844	1.000	1.125	1.000	15	6 1/4	20 1/8	10	15 1/8	5	10	5	12 1/2	10	
12	12.750	.180	250	.330	.375	.406	.562	.500	.688	.844	1.000	1.125	1.312	1.000	18	7 1/2	24 1/8	12	18 1/8	6	10	6	15	12	
14	14.000	.250	312	.375	.375	.438	.594	.500	.750	.938	1.094	1.250	1.406	...	21	8 1/8	28	14	21	6 1/2	12	...	16 1/2	14	
16	16.000	.250	312	.375	.375	.500	.656	.500	.844	1.031	1.219	1.438	1.594	...	24	10	32	16	24	7	12	...	18 1/2	16	
18	18.000	.250	312	.438	.375	.562	.750	.500	.938	1.156	1.375	1.562	1.781	...	27	11 1/4	36	18	27	8	12	...	21	18	
20	20.000	.250	375	.500	.375	.594	.812	.500	1.031	1.281	1.500	1.750	1.969	...	30	12 1/4	40	20	30	9	12	...	23	20	
24	24.000	.250	375	.562	.375	.688	.969	.500	1.219	1.531	1.812	2.062	2.344	...	36	15	48	24	36	10 1/2	12	...	27 1/2	24	
30	30.000	.312	500	.625	.375500	45	18 1/2	60	30	45	10 1/2	30	
36	36.000	.312	500	.625	.375	.750500	54	22 1/4	...	36	54	10 1/2	
42	42.000375500	63	26	...	42	...	12	
48	48.000375500	72	29 1/4	...	48	...	13 1/2	

Nom. Pipe Size	Outlet	STRAIGHT TEE			Nom. Pipe Size	Outlet	REDUCING TEE			Nom. Pipe Size	Outlet	CONCENTRIC REDUCER			Nom. Pipe Size	Outlet	ECCENTRIC REDUCER		
		C	M	H			C	M	H			C	M	H			C	M	H
3/4	3/4	1 1/8	3 1/2	3 1/2	3 3/4	10	10	8 1/2	20	20	15
1/2	1/2	1 1/8	...	1 1/2		3	3 1/2	3 3/4	...		4	8	8 1/2	8		7	18	15	14 1/2
1	1	1 1/2	4	2 1/2	3 1/2	3 3/4	4	12	12	8 1/2	7 1/2	7	24	14	15	14	20
3/4	3/4	1 1/2	1 1/2	2		2	3 1/2	3 3/4	4		4	6	8 1/2	7 1/2		7	10	15	13 3/8
1 1/2	1 1/2	1 1/2	1 1/2	2	5	1 1/2	3 1/2	4 1/8	3 3/4	14	14	8 1/2	7 1/4	7	30	10	15	13 1/2	20
1	1	1 1/2	1 1/2	2		4	3 1/2	4 1/8	3 3/4		4	10	10	9 1/2		8	24	17	...
1 1/4	1 1/4	1 1/8	6	2 1/2	4 1/8	3 3/4	4	16	16	10	9	8	36	20	17	17	20
3/4	3/4	1 1/8	1 1/8	2		2 1/2	4 1/8	3 3/4	4		4	8	10	8 1/8		8	18	17	16 1/2
1 1/2	1 1/2	2 1/4	8	1 1/2	4 1/8	3 3/4	4	18	18	11	42	14	17	16	20
1	1	2 1/4	2 1/4	2 1/2		5	4	4 1/8	3 3/4		4	12	11	10 1/8		13	30	22	...
2	2	2 1/4	2 1/4	2 1/2	6	2 1/2	4 1/8	3 3/4	4	14	14	11	10 1/8	13	30	24	22	21	24
1 1/4	1 1/4	2 1/4	2 1/4	2 1/2		3	4 1/8	4 1/8	3 3/4		4	8	11	9 3/4		13	20	22	20
2 1/2	2 1/2	2 1/2	2 1/2	2 1/2	6	2	4 1/8	3 3/4	4	16	16	12	36	16	22	19	24
1 1/2	1 1/2	2 1/2	2 1/2	2 1/2		5	4	4 1/8	3 3/4		4	12	12	12		14	30	22	...
2	2	3	8	3 1/2	5 1/8	5 1/8	5 1/2	18	18	12	11 1/8	14	42	36	26 1/2
1 1/2	1 1/2	3	2 3/4	3 1/2		4	5 1/8	5 1/8	5 1/2		5 1/2	12	12	11 1/8		14	30	26 1/2	25
3	3	3	2 3/4	3 1/2	8	3	5 1/8	5 1/8	5 1/2	18	18	12	10 3/4	14	42	24	26 1/2	23	24
2 1/2	2 1/2	3	2 1/2	3 1/2		2 1/2	5 1/8	4 3/4	5 1/2		5 1/2	8	12	10 3/4		14	18	26 1/2	22 1/2
1 1/4	1 1/4	3	2 1/2	3 1/2	8	3 1/2	5 1/8	4 3/4	5 1/2	18	18	13 1/2	42	16	26 1/2	22	24
1	1	3	2 1/2	3 1/2		4	7	6 1/8	6		6	10	13 1/2	12 1/2		15	20	30	28
3	3	3 3/8	8	4	7	6 1/8	6	18	18	13 1/2	13	15	42	30	30	28	24
2 1/2	2 1/2	3 3/8	3	3 1/2		5	7	6 1/8	6		6	12	13 1/2	12 1/2		15	30	30	26
1 1/2	1 1/2	3 3/8	2 3/4	3 1/2	8	3 1/2	7	6 1/8	6	18	18	13 1/2	11 1/4	15	42	24	30	26	24
1	1	3 3/8	2 3/4	3 1/2		3 1/2	7	6 1/8	6		6	8	13 1/2	11 1/4		15	20	30	26

BUTTWELD FITTINGS

SIZES: 1/2" to 24"

Buttweld fittings (except coppernickel Class 200/700) conform to ANSI B16.9 dimensions. See adjoining page. CopperNickel 90/10 and 70/30 buttweld fittings: Class 200 and 700 are the more common schedules & conform to Dwg 1385880 dimensions, on page 181.

Ordering Info: by description or 3 digit material code + 3 digit fitting type code + size

MATERIAL	CODE	FITTING TYPE	CODE
CopperNickel - 90/10		LR 90 Ell	111
	Class 200	SR 90 Ell	101
	Std Sch 40	Reducing 90 Ell	112
		45 Ell	104
CopperNickel - 70/30		Tee	121
	Class 200	Reducing Tee	122
	Class 700	Cap	154
		Lateral	140
		Cross	135
Steel - A234 WPB		Stub End	159
	Std/Sch 40	180 Return Bend Open/Long	156
	XH/Sch 80	180 Return Bend Close/Short	155
	Sch 120	Concentric Reducer	150
	Sch 160	Eccentric Reducer	149
	XXH	22 1/2 Ell	103
		3R 90Ell (3 times radius)	113
Stainless - 304/304L, 316/316L	TubeOD		653OD
	Sch 10		653
	Sch 40/Std		654
	Sch 80/XH		655
	Sch 160		656
Aluminum - 6061	Sch 40		664
	Sch 80		665
Aluminum - 5086	Sch 40		666
	Sch 80		667

Additional: Special shapes and sizes, schedules/wall thickness available

Bulkhead sleeve pg 105
SweepTees coppernickel only pg 181



LR 90
611



SR 90
601



45
104



Tee
121

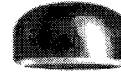

Cap
154



Cross
135



Lateral
140



Stub End
159



180 LR
Return
Bend
156



180 SR
Return
Bend
155



Concentric
Reducer
150



Eccentric
Reducer
149

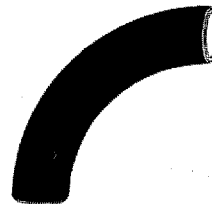

3 Radius
90 Ell
113



Reducing
90 Ell
112



Reducing
Tee
122

"SIL-BRAZE" BRONZE FITTINGS AND FLANGES

**SIZES: 1/8" - 12" PIPE SIZE FITTINGS
1/4" - 14" PIPE SIZE FLANGES**

Bronze silver braze(SIL-BRAZE) fittings and flanges are made of ASTM B-61 or B-62 Bronze and are constructed with a pipe-sized end socket with precision groove for silver ring insert which permits joining without additional silver solder. Absence of threads means there is no reduction of strength at the joint, and thin wall pipe may be used.

These fittings are designed for use with IPS Brass Pipe, IPS Copper Pipe and Copper Nickel Pipe, all with Iron Pipe Size diameters. They are not for use with types K,L,M Copper Water Tube (pg 111) which have tube size diameters. See pg 102 for these tube size fittings.

**FITTINGS: Meet Military Requirement of MIL-F-1183
200 LB WSP to 6" size
150 LB WSP 8" and above**

**FLANGES: ANSI B-16.24 150, 300 LB WSP Commercial
MIL-F-20042 150, 250, 400LB WOG Navy type
Dwg 810-1385892 200LB WOG Navy Butterfly
Dimensions and drilling pages 197, 203**

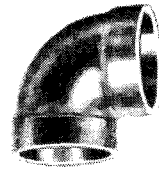

90 El
605101

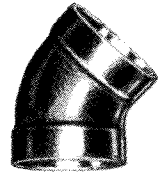

45 El
605104

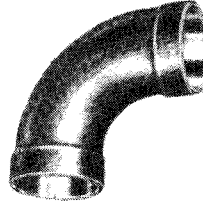

Long Turn 90
605111

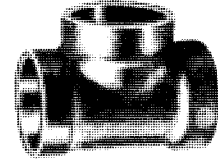

Tee
605121



Single Sweep Tee
605130

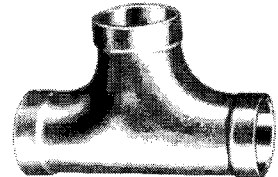

Double Sweep Tee
605133

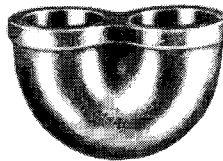

180 Return
LR/SR 605156/55

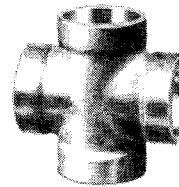

Cross
605135

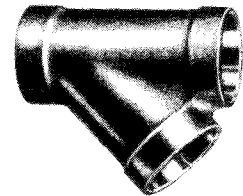

Y-Branch
605140



Plug
605065

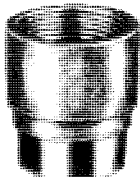

Female Adapter
Male Braze x Female Thread
605063

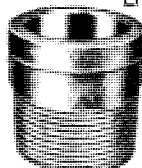

Male Adapter
Female Braze x Male Thread
605160

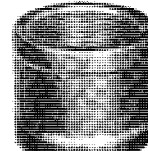

Adapter Coupling
Female Braze x Female Thread
605151



ST 90 El
x Male Thread 605107
x Male Braze 605108

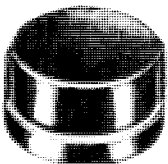

Cap
605154



Coupling
605150



Reducer
605150R



Bushing
605157

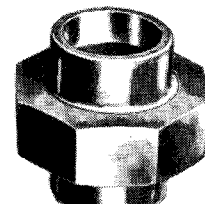

Union
605301

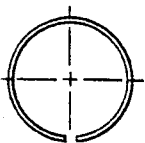

Silbraze
Ring
605197

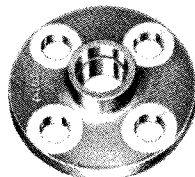

Flange
150 ANSI 605170
300 ANSI 605570
150 NAVY 605175
250 NAVY 605181

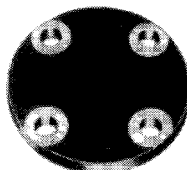

Blind Flange
150 ANSI 605072
300 ANSI 605076
150 NAVY 605077
250 NAVY 605081

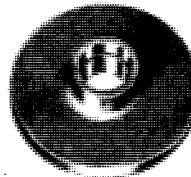

Undrilled Flange
150 ANSI 605270
150 NAVY 605275
DIN pn6/10 605280
JIS 5/10k 605285

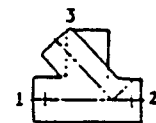

Reducing Fittings
Specify by size 1-2-3
add "R" to part #

PIPE NIPPLES

SIZES: 1/8" to 8"

Ordering info: by description or coding + size

MATERIAL		CODE	TYPE/LENGTH	CODE
Brass	Standard	603	King Combination Nipple	700
	Extra Heavy	604		Hex Nipple
Black Welded	STD	611	"Close" Length	900
	XH	613		
Black Seamless	STD	611S	"Short" Length	Varies**
	XH	613S		
Galvanized*	STD	610	x 1 1/2" Length	915
	XH	612	x 2	920
Chrome Plated Brass	STD	603C	x 2 1/2	925
	XH	604C	x 3	930
Stainless*	STD	650	x 3 1/2	935
	specify grade XH	651	x 4	940
CopperNickel	90/10 STD	601	x 4 1/2	945
	70/30 STD	602	x 5	950
Monel	STD	636	x 5 1/2	955
	XH	637	x 6	960
Aluminum	STD	660	x 8	980
	specify grade XH	661	x 10	990
PVC	Sch 80	668	x 12	992
CPVC	Sch 80	669		

other lengths available
 thread one end (T.O.E.) available
 swage and hex nipples are a standard length

* available welded or seamless

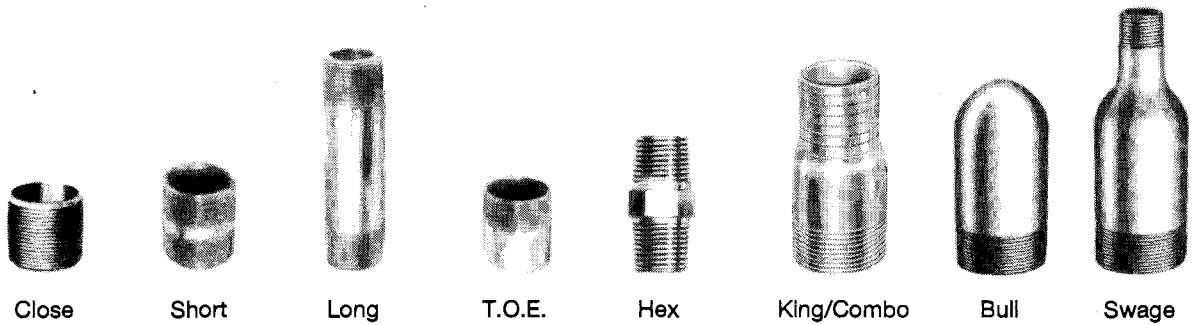

Pipe Size	1/8	1/4	3/8	1/2	3/4	1	1 1/4	1 1/2	2	2 1/2	3	4
"Close" Length	3/4	7/8	1	1 1/8	1 3/8	1 1/2	1 5/8	1 3/4	2	2 1/2	2 5/8	2 7/8
**"Short" Length	1 1/2	1 1/2	1 1/2	1 1/2	1 1/2	2	2	2	2 1/2	3	3	4

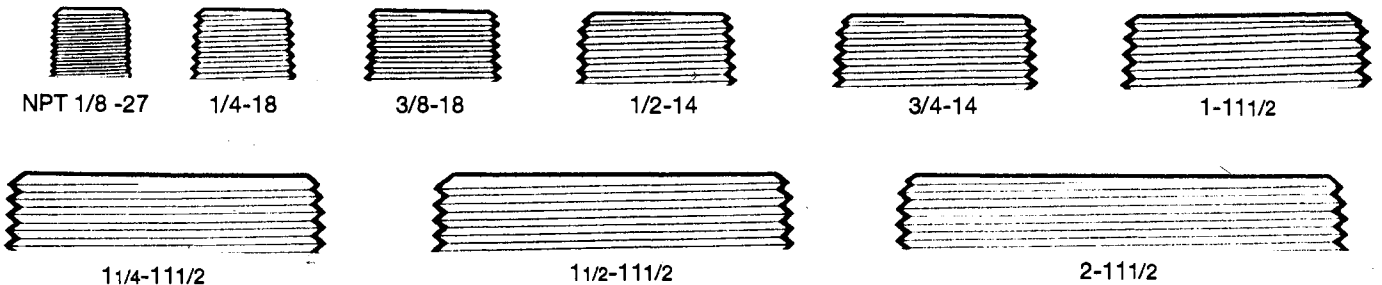

OUTLET FITTINGS

Outlet fittings are designed to be welded onto an existing "run" of pipe to provide a branch or "outlet" connection without having to cut run pipe. Outlet connection can be threaded, socketweld, braze, or buttweld. Outlet fittings provide 90° or 45° (elbolet) connections. They are typically described by two sizes: "run" by "outlet". For example a 4x2 socketlet fits on a 4" run of pipe with a 2" socket outlet size.

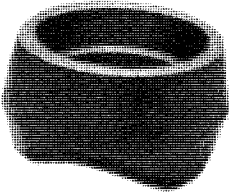

Socket or Braze Outlet

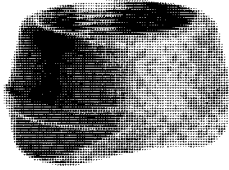

FPT Outlet

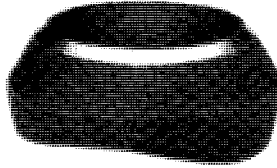

Buttweld Outlet

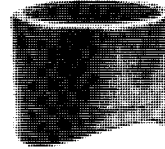

FPT Outlet



Pilot Boss
(Socket or Braze)
Solid Bottom

Bronze	695320	695310	—	695350	695340
90/10	695120	695110	695130	695150	695140
70/30	695220	695210	695230	695250	695240
Steel	695420	695410	695430	695450	694440
F-11	695520	695510	695530	695550	695540
Stainless	695720	695710	695730	695750	695740
Aluminum	695620	695610	695630	695650	695640
Monel	695920	695910	695930	695950	695940



Elbow Socket/Braze Outlet

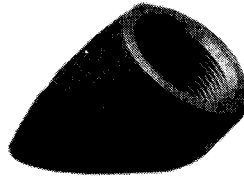

Elbow FPT Outlet

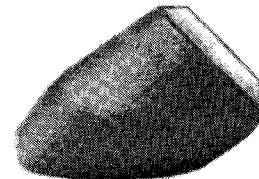

Elbow Buttweld Outlet

Bronze	697320	697310	697330
90/10	697120	697110	697130
70/30	697220	697210	697230
Steel	697420	697410	697430
F-11	697520	697510	697530
Stainless	697720	697710	697730
Aluminum	697620	697610	697630
Monel	697920	697910	697930

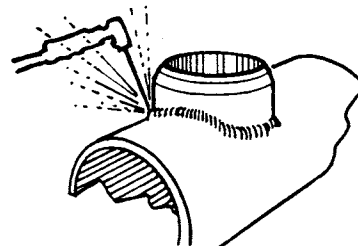
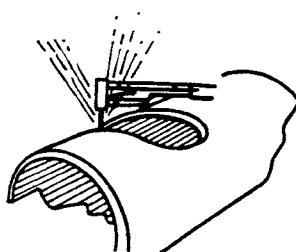
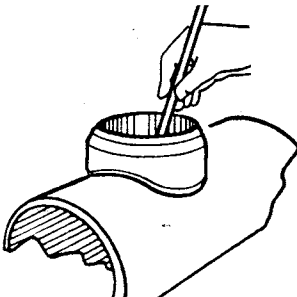

FLANGES & DIMENSIONS

Flanges to ANSI B16.5 standards are available in all materials and pressure classes. Common flange types are listed below. Metric flanges to DIN and JIS standards see page 98. For Navy and Mil-Spec flanges see pages 189-190.

To order: by *description* or specify 3 digit material code + 1 digit pressure class code + 2 digit flange code + facing suffix + bore (applicable to socketweld and weldneck only) + size.

	MATERIAL	PRESSURE	TYPE	FACING	BORE
680	Steel A105	1 150	00 Slip On	RF Raised Face	STD/Sch 40
670	Stainless 304/304L	3 300	20 Threaded	FF Flat Face	XH/Sch 80
671	Stainless 316/316L	6 600	40 Socketweld	RTJ Ring Type Joint	XXH/Sch 160
660	Aluminum 6061	8 900	60 Weldneck		
661	Aluminum 5086	9 1500	70 Silbraz		
689	CopperNickel 90/10		80 Blind		
687	CopperNickel 70/30		85 Undrilled Slip On		
681	Chromemoly F11		90 Lap Joint		
682	Chromemoly F22		95 Backing		
685	Monel 400				
603	Bronze Threaded				
605	Bronze Silbraz				

also available:
A20 and other stainless alloys
A350 low temperature
Titanium

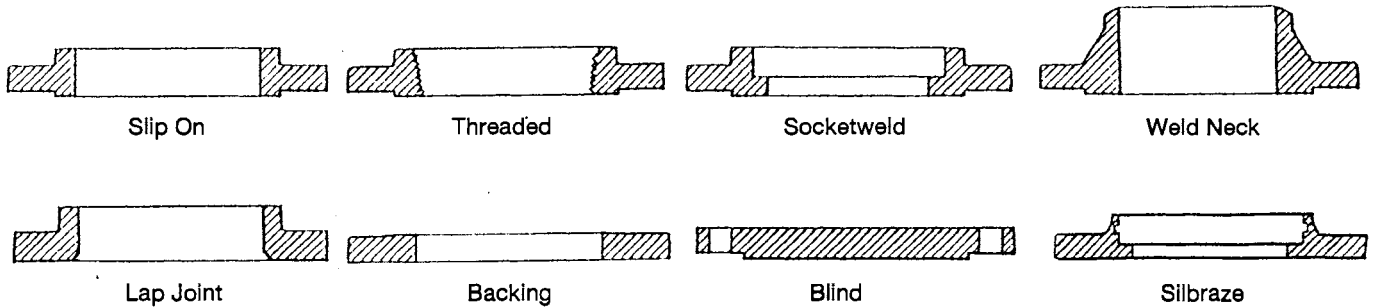

IPS Pipe Size	150 LB				300 LB				600 LB				900 LB				1500 LB			
	Nom. Diam.	Thick.	Bolt Circle	No. and Size of Holes	Diam.	Thick.	Bolt Circle	No. and Size of Holes	Diam.	Thick.	Bolt Circle	No. and Size of Holes	Diam.	Thick.	Bolt Circle	No. and Size of Holes	Diam.	Thick.	Bolt Circle	No. and Size of Holes
1/4	3-1/2	7/16	2-3/8	4-5/8	3-3/4	9/16	2-5/8	4-5/8	3-3/4	9/16	2-5/8	4-5/8	4-3/4	7/8	3-1/4	4-7/8	4-3/4	7/8	3-1/4	4-7/8
3/8	3-1/2	7/16	2-3/8	4-5/8	3-3/4	9/16	2-5/8	4-5/8	3-3/4	9/16	2-5/8	4-5/8	4-3/4	7/8	3-1/4	4-7/8	4-3/4	7/8	3-1/4	4-7/8
1/2	3-1/2	7/16	2-3/8	4-5/8	3-3/4	9/16	2-5/8	4-5/8	3-3/4	9/16	2-5/8	4-5/8	4-3/4	7/8	3-1/4	4-7/8	4-3/4	7/8	3-1/4	4-7/8
3/4	3-7/8	1/2	2-3/4	4-5/8	4-5/8	5/8	3-1/4	4-3/4	4-5/8	5/8	3-1/4	4-3/4	5-1/8	1	3-1/2	4-7/8	5-1/8	7/8	3-1/2	4-7/8
1	4-1/4	9/16	3-1/8	4-5/8	4-7/8	11/16	3-1/2	4-3/4	4-7/8	11/16	3-1/2	4-3/4	5-7/8	1-1/8	4	4-1	5-7/8	1-1/8	4	4-1
1-1/4	4-5/8	5/8	3-1/2	4-5/8	5-1/4	3/4	3-7/8	4-3/4	5-1/4	13/16	3-7/8	4-3/4	8-1/4	1-1/8	4-3/8	4-1	8-1/4	1-1/8	4-3/8	4-1
1-1/2	5	11/16	3-7/8	4-5/8	6-1/8	13/16	4-1/2	4-7/8	6-1/8	7/8	4-1/2	4-7/8	7	1-1/4	4-7/8	4-1-1/8	7	1-1/4	4-7/8	4-1-1/8
2	8	3/4	4-3/4	4-3/4	6-1/2	7/8	5	8-3/4	6-1/2	1	5	8-3/4	8-1/2	1-1/2	6-1/2	8-1	8-1/2	1-1/2	6-1/2	8-1
2-1/2	7	7/8	5-1/2	4-3/4	7-1/2	1	5-7/8	8-7/8	7-1/2	1-1/8	5-7/8	8-7/8	9-5/8	1-5/8	7-1/2	8-1-1/8	9-5/8	1-5/8	7-1/2	8-1-1/8
3	7-1/2	15/16	6	4-3/4	8-1/4	1-1/8	6-5/8	8-7/8	8-1/4	1-1/4	6-5/8	8-7/8	9-1/2	1-1/2	7-1/2	8-1	10-1/2	1-7/8	8	8-1-1/4
3-1/2	8-1/2	15/16	7	8-3/4	9	1-3/16	7-1/4	6-7/8	9	1-3/8	7-1/4	8-1	10-3/4	11			11			
4	9	15/16	7-1/2	8-3/4	10	1-1/4	7-7/8	8-7/8	10-3/4	1-1/2	8-1/2	8-1	11-1/2	1-3/4	9-1/4	8-1-1/4	12-1/4	2-1/8	9-1/2	8-1-3/8
5	10	15/16	8-1/2	8-7/8	11	1-3/8	9-1/4	8-7/8	13	1-3/4	10-1/2	8-1-1/8	13-3/4	2	11	8-1-3/8	14-3/4	2-7/8	11-1/2	8-1-5/8
6	11	1	9-1/2	8-7/8	12-1/2	1-7/16	10-5/8	12-7/8	14	1-7/8	11-1/2	1-1/8	15	2-3/16	12-1/2	1-1/4	15-1/2	3-1/4	12-1/2	1-1/2
8	13-1/2	1-1/8	11-3/4	8-7/8	15	1-5/8	13	12-1	16-1/2	2-3/16	13-3/4	1-1/4	18-1/2	2-1/2	15-1/2	1-1/2	19	3-5/8	15-1/2	1-3/4
10	16	1-3/16	14-1/4	12-1	17-1/2	1-7/8	15-1/4	16-1-1/8	20	2-1/2	17	16-1-3/8	21-1/2	2-3/4	18-1/2	1-1/2	23	4-1/4	19	12-2
12	19	1-1/4	17	12-1	20-1/2	2	17-3/4	16-1-1/4	22	2-5/8	19-1/4	20-1-3/8	24	3-1/8	21	20-1-1/2	26-1/2	4-7/8	22-1/2	16-2-1/8
14	21	1-3/8	18-3/4	12-1-1/8	23	2-1/8	20-1/4	20-1-1/4	23-3/4	2-3/4	20-3/4	20-1-1/2	25-1/4	3-3/8	22	20-1-5/8				
16	23-1/2	1-7/8	21-1/4	16-1-1/8	25-1/2	2-1/4	22-1/2	20-1-3/8	27	3	23-3/4	20-1-5/8	27-3/4	3-1/2	24-1/4	20-1-3/4				
18	25	1-9/16	22-3/4	16-1-1/4	28	2-3/8	24-3/4	24-1-3/8	29-1/4	3-1/4	25-3/4	20-1-3/4	31	4	27	20-2				
20	27-1/2	1-11/16	25	20-1-1/4	30-1/2	2-1/2	27	24-1-3/8	32	3-1/2	28-1/2	24-1-3/4	33-3/4	4-1/4	29-1/2	20-2-1/8				
24	32	1-7/8	29-1/2	20-1-3/8	36	2-3/4	32	24-1-5/8	37	4	33	24-2	41	5-1/2	35-1/2	20-2-5/8				
30	38-3/4	2-1/8	36	28-1-3/8	43	3-5/8	39-1/4	28-1-7/8	44-1/2	4-1/2	40-1/2	28-2-1/8	48-1/2	5-7/8	42-3/4	20-3-1/8				
36	46	2-3/8	42-3/4	32-1-5/8	50	4-1/8	46	32-2-1/8	51-3/4	5	47	28-2-5/8	57-1/2	6-3/4	50-3/4	20-3-5/8				



Type C Stub End with lap joint flange

Note: Metric flanges - see next page
400 LB, 2500 LB available - More complete diimension charts, showing bolting lengths: pgs 199-201.

METRIC FLANGES & DIMENSIONS

Ordering info: Nom dia and DIN / JIS Class or part number

NOM DIA (mm)	DIN PN6 900106	DIN PN10 900110	DIN PN16 900116	DIN PN25 900125	DIN PN40 900140	JIS 5K 900005	JIS 10K 900010	JIS 16K 900016	JIS 20K 900020	JIS 40K 900040	NOM DIA (mm)
15	D BC H 80 55 4 x 11	95 65 4 x 14	95 65 4 x 14	95 65 4 x 14	95 65 4 x 14	80 60 4 x 12	95 70 4 x 15	95 70 4 x 15	95 70 4 x 15	115 80 4 x 19	15
20	90 65 4 x 11	105 75 4 x 14	105 75 4 x 14	105 75 4 x 14	105 75 4 x 14	85 65 4 x 12	100 75 4 x 15	100 75 4 x 15	100 75 4 x 15	120 85 4 x 19	20
25	100 75 4 x 11	115 85 4 x 14	115 85 4 x 14	115 85 4 x 14	115 85 4 x 14	95 75 4 x 12	125 90 4 x 19	125 90 4 x 19	125 90 4 x 19	130 95 4 x 19	25
32	120 90 4 x 14	140 100 4 x 18	140 100 4 x 18	140 100 4 x 18	140 100 4 x 18	115 90 4 x 15	135 100 4 x 19	135 100 4 x 19	135 100 4 x 19	140 105 4 x 19	32
40	130 100 4 x 14	150 110 4 x 18	150 110 4 x 18	150 110 4 x 18	150 110 4 x 18	120 95 4 x 15	140 105 4 x 19	140 105 4 x 19	140 105 4 x 19	160 120 4 x 23	40
50	140 110 4 x 14	165 125 4 x 18	165 125 4 x 18	165 125 4 x 18	165 125 4 x 18	130 105 4 x 15	155 120 4 x 19	155 120 8 x 19	155 120 8 x 19	165 130 8 x 19	50
65	160 130 4 x 14	185 145 4 x 18	185 145 4 x 18	185 145 8 x 18	185 145 8 x 18	155 130 4 x 15	175 140 4 x 19	175 140 8 x 19	175 140 8 x 19	200 160 8 x 23	65
80	190 150 4 x 18	200 160 8 x 18	200 160 8 x 18	200 160 8 x 18	200 160 8 x 18	180 145 4 x 19	185 150 8 x 19	200 160 8 x 23	200 160 8 x 23	210 170 8 x 23	80
100	210 170 4 x 18	220 180 8 x 18	220 180 8 x 18	235 190 8 x 22	235 190 8 x 22	200 165 8 x 19	210 175 8 x 19	225 185 8 x 23	225 185 8 x 23	250 205 8 x 25	100
125	240 200 8 x 18	250 210 8 x 18	250 210 8 x 18	270 220 8 x 26	270 220 8 x 26	235 200 8 x 19	250 210 8 x 23	270 225 8 x 25	270 225 8 x 25	300 250 8 x 27	125
150	265 225 8 x 18	285 240 8 x 22	285 240 8 x 22	300 250 8 x 26	300 250 8 x 26	265 230 8 x 19	280 240 8 x 23	305 260 12 x 25	305 260 12 x 25	355 295 12 x 33	150
175	295 255 8 x 18	315 270 8 x 22	315 270 8 x 22	330 280 12 x 26	350 295 12 x 30	300 260 8 x 23	305 265 12 x 23				175
200	320 280 8 x 18	340 295 8 x 22	340 295 12 x 22	360 310 12 x 26	375 320 12 x 30	320 280 8 x 23	330 290 12 x 23	350 305 12 x 25	350 305 12 x 25	405 345 12 x 33	200
250	375 335 12 x 18	395 350 12 x 22	405 355 12 x 26	425 370 12 x 30	450 385 12 x 33	385 345 12 x 23	400 355 12 x 25	430 380 12 x 27	430 380 12 x 27	475 410 12 x 33	250
300	440 395 12 x 22	445 400 12 x 22	460 410 12 x 26	485 430 16 x 30	515 450 16 x 33	430 390 12 x 23	445 400 16 x 25	480 430 16 x 27	480 430 16 x 27	540 470 16 x 39	300
350	490 445 12 x 22	505 460 16 x 22	520 470 16 x 26	555 490 16 x 33	580 510 16 x 36	480 435 12 x 25	490 445 16 x 25	540 480 16 x 33	540 480 16 x 33	585 515 16 x 39	350
400	540 495 16 x 22	565 515 16 x 26	580 525 16 x 30	620 550 16 x 36	660 585 16 x 39	540 495 16 x 25	560 510 16 x 27	605 540 16 x 33	605 540 16 x 33	645 570 16 x 39	400
450	595 550 16 x 22	615 565 20 x 26	640 585 20 x 33	670 600 20 x 36	755 670 20 x 42	605 555 16 x 25	620 565 20 x 27	675 605 20 x 33			450
500	645 600 20 x 22	670 620 20 x 26	715 650 20 x 33	730 660 20 x 36	795 670 20 x 42	655 605 20 x 25	675 620 20 x 27	730 660 20 x 33		D BC H	500

D: Flange Diameter
 BC: Bolt Circle Diameter
 H: Bolt Holes x Hole Diameter
 1 inch = 25.4 mm













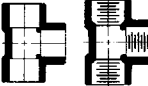

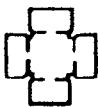









PVC AND CPVC

Plastic fittings in Sch 40 and Sch 80 for normal (PVC) and high temperature (CPVC) applications.





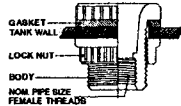
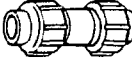

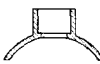









SIZES: 1/4" to 12" and 16, 20, 25, 32, 40, 50, 63, 75mm OD

MATERIALS:	PVC Sch 40	Slip Type (White)	805
	PVC Sch 40	Threaded (White)	803
	PVC Sch 80	Slip Type (Gray)	806
	PVC Sch 80	Threaded (Gray)	804
	CPVC Sch 80	Slip Type (Lt Gray)	808
	CPVC Sch 80	Threaded (Lt Gray)	807
	ABS / DWV	Slip Type (White)	809







Pressure Fittings: 803-808 series

							
90° Elbow 101	45° Elbow 104	Street 90° 107	Tee 121	Coupling 150	Union 301	Cross 135	Cap 154
							
Male Adapter 160	Female Adapter 063	Bushing SPG x S 157	Bushing SPG x T 159	Bushing MPT x FPT 158	Reducer Coupling 150R	Reducing Tee SxSxS 121R	Reducing Tee SxSxFPT 122R
							
Flange 2pc Van Stone Type 172	Flange 1pc Solid 170	Flange Blind 180	90° Elbow SxFPT 102	Pipe Strap 887	Nipple Spec. Length 900	Pipe All Types	Glue Cleaner Primer
							
		Bulkhead Union Slip+Thd		Compression Couplings	Insert Barb Fgts + Adapters	Pipe Saddle	

Sanitary Fittings: 809 series

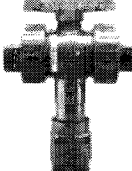
							
1/4 Bend 101S	Long Sweep 1/4 Bend 111S	1/8 Bend 104S	1/6 Bend 106S	1/16 Bend 105S	1/4 Bend Street 107S	1/8 Bend Street 109S	Reducer 157S
							
Wye Branch 140S	Double Wye 142S	Cleanout Tee 122S	Sanitary Tee 124S	Double Sanitary Tee 125S	Long Turn Tee Wye 143S	Male Adapter 160S	Female Adapter 063S

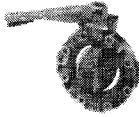
Valves

							
1 piece Ball	True Union Ball	Ball Check	3 Way Ball	Metering Y-Type	Foot Valve	Butterfly Valve	Gate Valve

FIBER (FRP) RE-INFORCED PLASTIC PIPE & FITTINGS

SIZES: 1, 1 1/2, 2, 3, 4, 6 to 36 IPS

Known by trade names as Bondstrand® and Fiberbond® and generally known as FRP pipe and fittings this product is a light weight fiber resin pipeline system approved for some ship board uses by ratings societies. Applications include ballast, drain, and inert effluent systems, and, in an anti-static formulation, petroleum lines.

Joining is accomplished by using 110/220v power to cure and bond the adhesive connection. Preparation tooling is required to make pipe ends ready for fitting socket or taper fit.

Not shown: Flanges to any drilling standard, Y Laterals, Outlet Saddles, Flanged Fittings-add "F" suffix to part numbers.

Pipe - use figure number 702000 M.

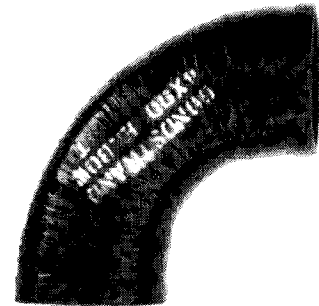

90° Ell
802111

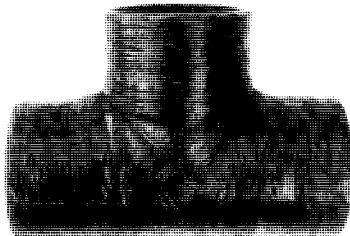

Tee
802121



Coupling
802150



Reducer
802150R



22° Ell
802102



45° Ell
802104

FLANGED FITTINGS TAPER FITTINGS SPOOL PIECES

SIZES: 1" to 16"

Materials: Bronze
Steel
Iron
Stainless
Aluminum
FRP-see above

Dimensions can conform to ANSI B16.1 (Iron) and B16e (steel).
Special dimensions and drillings also readily available.

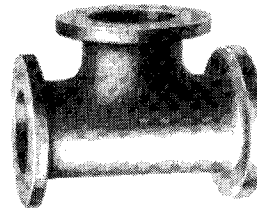
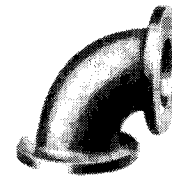

TUBE FITTINGS

Tube fittings are used with OD sized tubing. Sizes range from 1/8" OD to 2" OD.
 Examples: 1/8, 3/16, 1/4, 5/16, 3/8, 1/2, 5/8, 3/4, 7/8, 1, 1 1/4, 1 1/2, 2.
 Metric sizes are also available, listed in detail on page 103.
 When ordering tube fittings one side threaded end list tube size (nut end) first.

COMPRESSION TYPE

Flareless fittings designed with one piece ferrule sleeve for common application.
 Specify Material: Brass, Chrome Plated Brass, Nylon, Steel, Stainless Steel

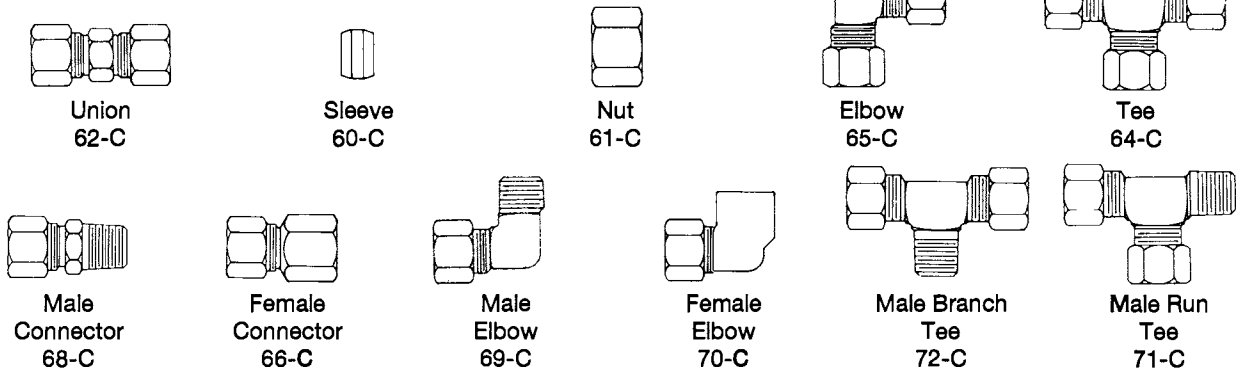

LOK TYPE / BITE TYPE

Flareless fittings designed with 2 piece LOK type ferrule for high pressure service applications.
 Specify material: Brass, Steel or Stainless

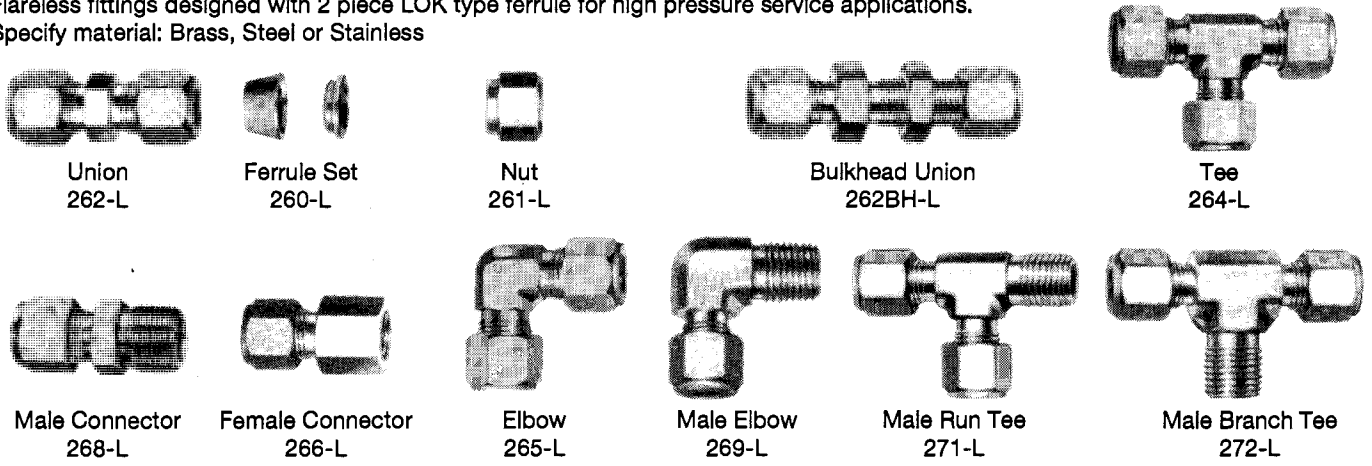

FLARE TYPE 45°

Fittings for common use or high vibration service, used with OD straight or coiled tubing.
 Specify Material: Brass, Steel or Stainless

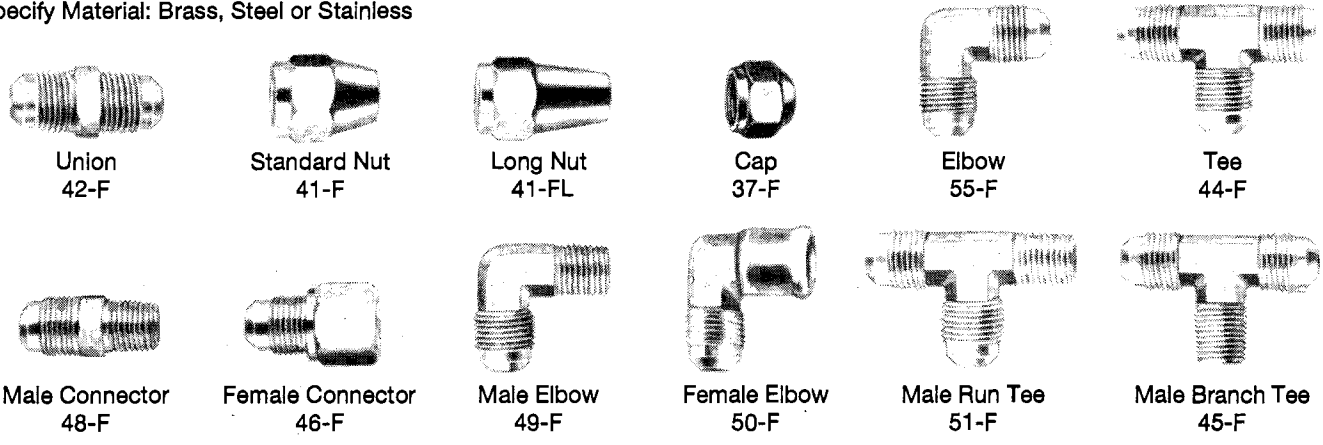

WROT COPPER SOLDER JOINT FITTINGS

For solder or sweat connections to copper tubing (Type K, L or M). Also available to fit metric copper tubing. Not suitable for pipe-sized brass, copper or coppernickel due to incompatible sizes. Typically ordered by nominal size which is 1/8" smaller than actual O.D. of connecting tube (see chart). Tube information is shown on page 111. Metric nominal sizes equal O.D. of tube.

Standard Sizes

Metric Sizes

Nominal Size of Fitting	Actual O.D. of Tube or ID of Fitting	Nominal Size	Actual O.D.
1/8	1/4	6mm	6
1/4	3/8	8mm	8
3/8	1/2	10mm	10
1/2	5/8	12mm	12
5/8	3/4	14mm	14
3/4	7/8	15mm	15
1	1 1/8	16mm	16
1 1/4	1 3/8	18mm	18
1 1/2	1 5/8	22mm	22
2	2 1/8	28mm	28
2 1/2	2 5/8	35mm	35
3	3 1/8	42mm	42
3 1/2	3 5/8	54mm	54
4	4 1/8		
5	5 1/8		
6	6 1/8		

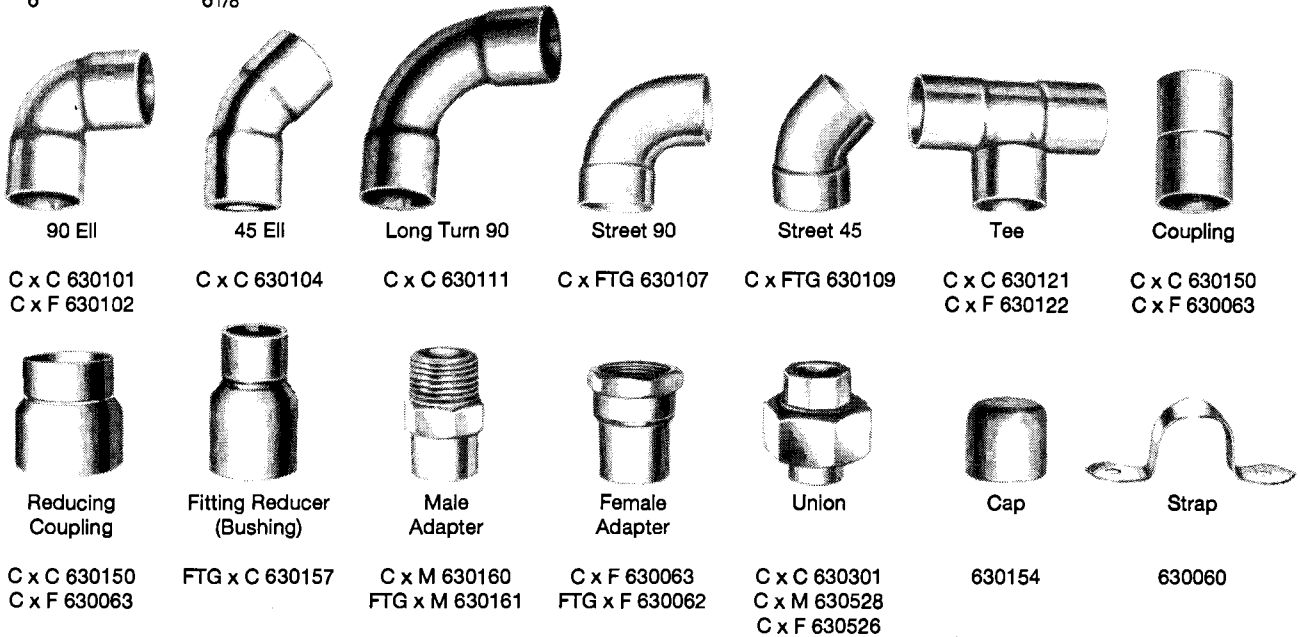

END CONNECTIONS:
C = Copper Solder Socket
M = Male Pipe Thread
F = Female Pipe Thread
FTG = Male Copper Tube End
(Fits into "C" socket)

125LB Flange
630170
Thickness Meets
125LB A.S.M.E. Standard



150LB Flange
630171
Thickness Meets
ANSI B16.24

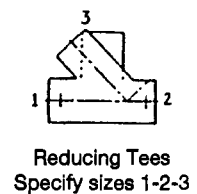

METRIC FITTINGS COMPRESSION

SIZES: 6 to 42 mm

Bite Type Flareless Fittings to DIN 2353
L Designation is "Light" Series
S Designation is "Heavy" Series
See tube chart for pressure indications

ORDERING INFO: Material or Code + Fitting # and size

STEEL 841
BRASS 843
STAINLESS 845

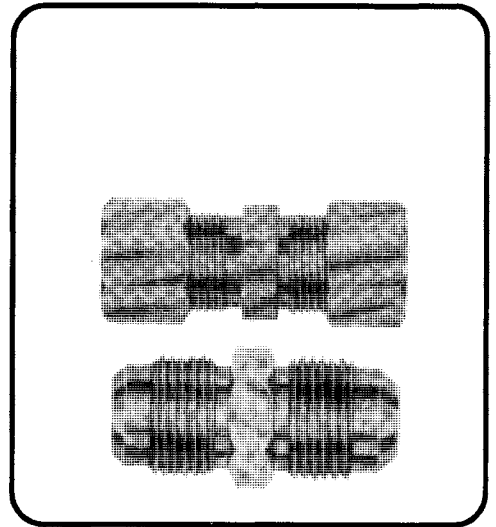

TUBE "D" mm	6	8	10	12	14	15	16	18	20	22	25	28	30	35	38
TYPICAL WALL mm	1.0 322	1.0 242	1.0 193	1.5 242	2.0 276	1.5 193	2.0 242	1.5 161	2.0 193	1.5 132	2.5 193	2.0 138	2.5 161	3.0 166	3.0
WITH OPERATING	1.5 483	1.5 363	1.5 280	2.0 322	2.5 345	2.0 258	2.5 302	2.0 215	2.5 242	2.0 176	3.0 232	3.0 207	3.0 193	4.0 221	4.0
PRESSURE (STEEL)	2.0 644	2.0 483	2.0 387	2.5 403	3.0 414	2.5 322	3.0 363	2.5 269	3.0 290	2.5 220	4.0 309	4.0 276	4.0 258	5.0 276	5.0
KG/CM ² 4:1SAFETY															

SIZE	KG	"W"90	"T" Tee	"G" Union	"GEV (BSP)" Stud Cplg*	"GEV(NPT)" Stud Cplg	"GEV (M)" Stud Cplg*	Bulkhead Union	"K" Cross	Support Clamp	Cutting Ring	"D" Nut
6L	250	101006	121006	150006	160006	161006	162006	155006	185006	548806	298006	297006
6S	630	101006S	121006S	150006S	160006S	161006S	162006S	155006S	185006S		298006S	297006S
8L	250	101008	121008	150008	160008	161008	162008	155008	185008	548808	298008	297008
8S	630	101008S	121008S	150008S	160008S	161008S	162008S	155008S	185008S		298008S	297008S
10L	250	101010	121010	150010	160010	161010	162010	158010	185010	548810	298010	297010
10S	630	101010S	121010S	150010S	160010S	161010S	155010S	158010S	185010S		298010S	297010S
12L	250	101012	121012	150012	160012	161012	162012	155012	185012	548812	298012	297012
12S	630	101012S	121012S	150012S	160012S	161012S	162012S	155012S	185012S		298012S	297012S
14S	630	101014	121014	150014	160014	161014	162014	155014	185014	548814	298014	297014
15L	250	101015	121015	150015	160015	161015	162015	155015	185015	548815	298015	297015
16S	400	101016	121016	150016	160016	161016	162016	155016	185016	548816	298016	297016
18L	160	101018	121018	151018	160018	161018	162018	155018	185018	548818	298018	297018
20S	400	101020	121020	150020	160020	161020	162020	155020	185020	548820	298020	297020
22L	160	101022	121022	150022	160022	161022	162022	155022	185022	548822	298022	297022
25S	400	101025	121025	150025	180025	161025	162025	155025	185025	548825	298025	297025
28L	100	101028	121028	150028	160028	161028	162028	155028	185028	548828	298028	297028
30S	250	101030	121030	150030	160030	161030	162030	155030	185030	548830	298030	297030
35L	100	101035	121035	150035	160035	161035	162035	155035	185035	548835	298035	297035
38S	250	101038	121038	150038	160038	161038	162038	155038	185038	548838	298038	297038
42L	100	101042	121042	150042	160042	161042	162042	155042	185042	548842	298042	297042

* Specify tapered or parallel threads for male stud couplings GEV(BSP). GEV(M) is metric straight thread.

METRIC FLARE TYPE

SIZES: 6 to 16mm

Copper tube with flared tube ends required to utilize these fittings, each connection using a nut, supplied separately.

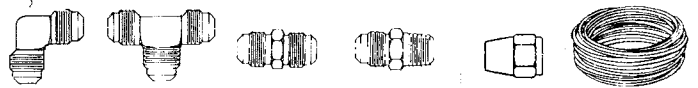

SIZE	90°	TEE	UNION	ADAPTER	NUT	TUBING
6	844106	844206	844306	844806	844906	900006
8	844108	844208	844308	844808	844908	900008
10	844110	844210	844310	844810	844910	900010
12	844112	844212	844312	844812	844912	900012
15	844115	844215	844315	844815	844915	900015
16	844116	844216	844316	844816	844916	900016

METRIC & IMPERIAL FITTINGS YORCALBRO

Silver Brazing Fittings

Aluminum brass with pre-inserted brazing rings for metric or imperial tubing.
Tubing listed on page 114.

To Order: Specify I.D. of fitting or O.D. of joining tube.

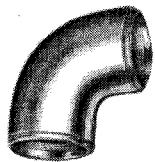

90 Ell
Metric 845101
Imperial 846101

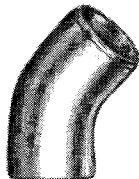

45 Ell
845104
846104

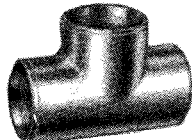

Tee
845121
846121



Coupling
845150
846150



Insert
845157
846160



Union
845301
846301

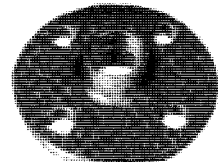

Flange
845170
846170

Buttweld Fittings

Aluminum brass or copper nickel alloy in sizes 2"/44.5mm and above. Add "BW" to above part numbers.

Tanker Union Compression Fittings

Tanker unions offer a mechanical connection of two tubes without high heat that brazing or welding would require. This mechanical connection is commonly used to repair tanker heating coils where high heat would be dangerous.

TU type have a single ferrule or "olive" which fits inside each tube which must be flared to provide proper seal. Surface pitting on outside of tube will not adversely affect seal.

SU type have teflon seals on the center body which seal against the inside of each flared end.

FC type use a compression type fit of external ferrules. Tube ends do not require flaring but do require smooth unpitted exterior tube ends.

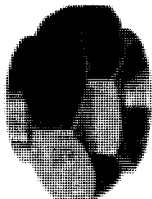

TU Type
Brass Ferrule/Olive
Metric 845301
Imperial 846301

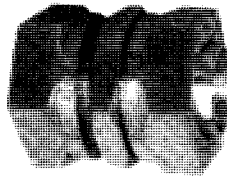

SU Type
Teflon Seals
845401
846401

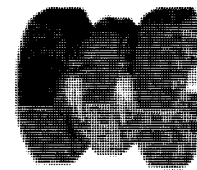

EFSC Type
Flareless
845525
845525

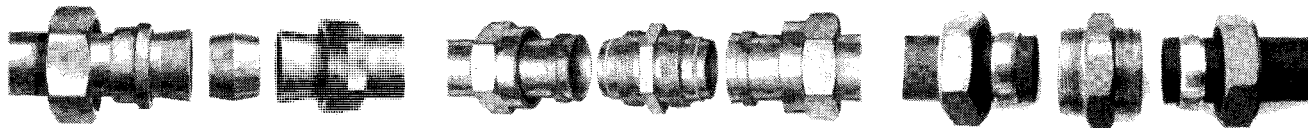

Metric Range

Size	mm	6	8	10	12	16	20	25	30	38	44.5	57	76.1	88.9	108	133	159
Fitting ID/Tube OD		6	8	10	12	16	20	25	30	38	44.5	57	76.1	88.9	108	133	159

Imperial Sizes

Size/Nominal Bore in.	1/2	3/4	1	1 1/4	1 1/2	2	2 1/2	3	3 1/2	4	5	6	8
Fitting ID/Tube OD	0.596	0.846	1.112	1.362	1.612	2.128	2.628	3.144	3.660	4.184	5.184	6.208	8.208

PIPE COUPLINGS

DRESSER/DIACOUP

SIZES: 1/2" to 36" IPS

Style 38 (Standard Length) and 40 (Long) couplings are available for all sizes of IPS sized pipe. Constructed of steel mid-ring and followers with resilient gaskets and steel tightening bolts. Also available in all stainless construction or galvanized steel, given lead time. Dresser type couplings can also be supplied for imperial and metric piping standards and OD pipe or tubing.

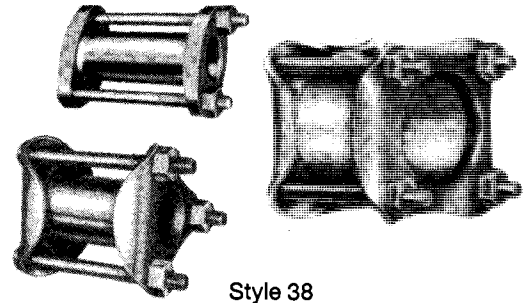

Style 38
541107

Gaskets are offered in a variety of resilient materials:

Grade 27 - Buna-S rubber for water service, max. temp. 212°F

Grade 42 - Buna-N rubber for oil and gas, max. temp. 150° F

Grade 27 armored - similar to plain Grade 27 gasket, but with brass helical coil embedded in tip of gasket to provide durable seal for critical service applications

Grade 42 armored - similar to plain Grade 42 gasket, but with brass helical coil embedded in tip of gasket to provide durable seal for critical service applications

Viton - For aromatic (eg. gasoline) service and/or high temperature (300°)

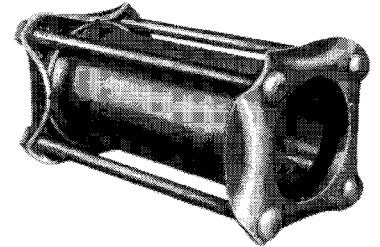

Style 40
541108

Size IPS	1	1 1/4	1 1/2	2	2 1/2	3	3 1/2	4	5	6	8	10	12	14	16	18	20	22	24	30	36
Pipe OD	1.31	1.66	1.90	2.38	2.88	3.5	4.0	4.5	5.56	6.63	8.63	10.75	12.75	14	16	18	20	22	24	30	36

Mid Ring Length: Style 38/541107

inches	5	5	5	4/5/7	5	4/5/7	4/5	4/5/7	4/5/7	4/5/7	4/5/7	5/7	5/7	7	7	7	7	7	7	7/10	7/10
weight	4	4	5	7	19	14	18	17	24	26	32	49	56	60	70	75	83	95	105	120	223

Mid Ring Length: Style 40/541108

inches	12	12	12	12	12	12	12	12	16	16	16	16	16	16	16	16	24	16	16/24	—	—
weight	6	9	10	15	20	23	25	28	41	51	63	78	93	133	173	176	192	224	240	—	—

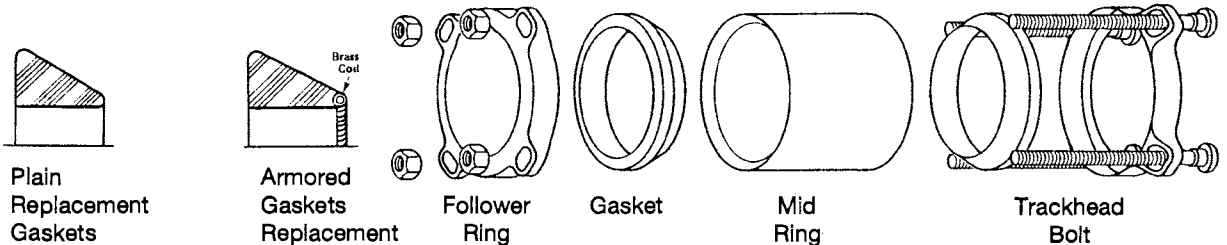

Plain
Replacement
Gaskets

GR 27 - Plain
GR 42 - Plain
GR 27 - Armored
GR 42 - Armored

Armored
Gaskets
Replacement

541112
541110
541113
541111

Follower
Ring

Specify
Pipe Size

Gasket

Specify
as at left

Mid
Ring

Specify
Pipe Size
and Ring
Length

Trackhead
Bolt

Steel - 541115
Stainless - 541117
Specify Bolt Length
or Coupling Size

DECK SLEEVE

PENETRATION

SIZES: 1/2" to 16" IPS

Steel, stainless steel or copper nickel construction to be welded into place. Allows pipe a sleeved penetration of deck or bulkhead. Typical length is 3 1/4". Order by pipe size.

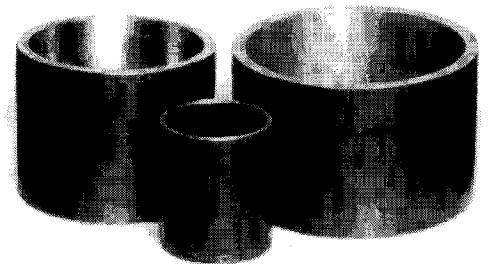

Steel 549999
Stainless 549998
Coppernickel 601555

HOSE CAPS, FITTINGS AND ADAPTERS

To order specify type of hose thread - see thread dimension chart on the following page.



CAMLOCK FITTINGS

SIZES: 1/2" to 12"

MATERIAL: Brass, Aluminum, Stainless

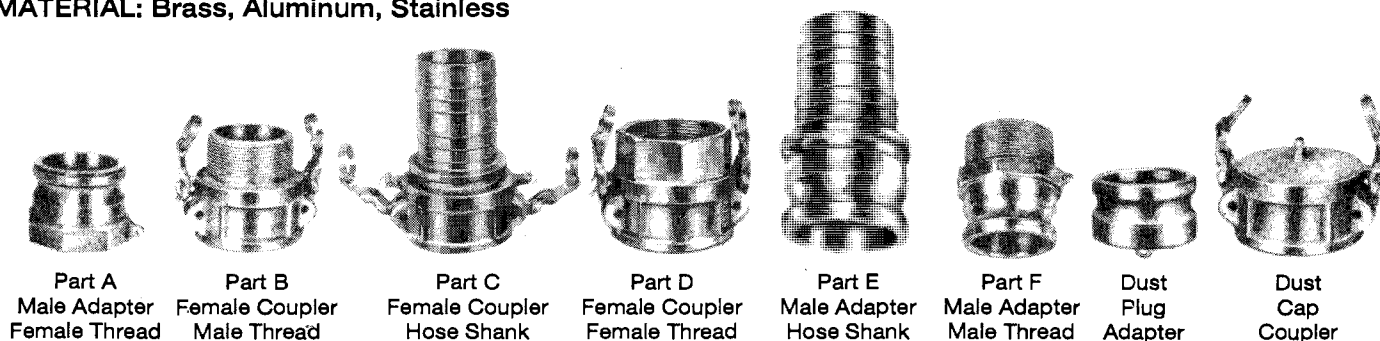

NORMACONNECT®

PIPE COUPLINGS

SIZES: 1" to 14"
25mm to 350mm

Compact design, stainless steel body joining and repair clamps with rubber seal in conjunction with metal bite grip which provides axial restraint. Flex type - without bite teeth - is available for appropriate applications as are segmented or open body style for encirclement of a complete line. Stainless hardware to 8". Available with EPDM liner for water service (-22°F to 212°F) or Buna-N (NBR) liner for gas or oil lines (-10°F to 180°F).

Specify pipe size or O.D.

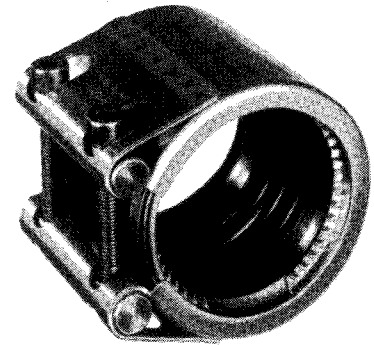

Grip Type 541101
Flex Type 541102

COMPRESSION COUPLINGS

SIZES: 3/8" to 3"

Non-weldable compression couplings offer an economical method for joining two pipes. Rubber sleeve/gasket is sealed against the pipe by tightening the end nut. Available in black iron, galvanized iron, brass, and PVC. Brass available both pipe and tube sizes. Some 90°, 45° and tees available.

Size IPS	3/8	1/2	3/4	1	1 1/4	1 1/2	2	2 1/2	3
Short Length	2 1/2	2 5/8	2 3/4	3 1/8	3 1/4	3 3/8	3 5/8	4 3/8	4 3/4
Long Length	—	4 1/4	5	5 5/8	6	6 3/4	6 3/4	—	—



Black	(long)	541001
Galvanized	(long)	541003
	(short)	541004
Brass	(pipe)	541005
	(tube)	541006
PVC		541008
CPVC		541009

DECK / BULKHEAD COUPLING

SIZES: 1/4" to 4"

Weldable deck / bulkhead penetration couplings with compression nut and rubber washer on one end provide seal around penetrating pipe. Double nut design joins pipes from each side of deck / bulkhead. Available in steel or aluminum.

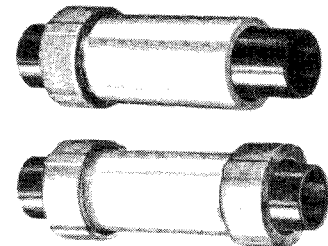

Aluminum	Single Nut	549995
	Double Nut	549996
Steel	Single Nut	549997
	Double Nut	549998

REPAIR CLAMP

SIZES: 1/2" to 24" Repair
2" to 14" Full encirclement

Repair clamps are used to repair holes or leaks in pipe. Typical economical style is stainless steel band type with rubber sleeve. Sizes refer to IPS size of pipe to be repaired. Lengths are standard 3" or 6", though longer lengths 9" and 12" are available.

Encirclement type will hold 360° repair and is a more costly unit. Width typically 8", 10"; Wider to 16" available.

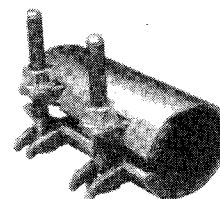

Repair
3" Width 541110
6" Width 541106

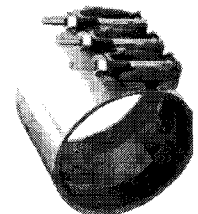

Encirclement
8" Width 541118
10" Width 541119

NOTES

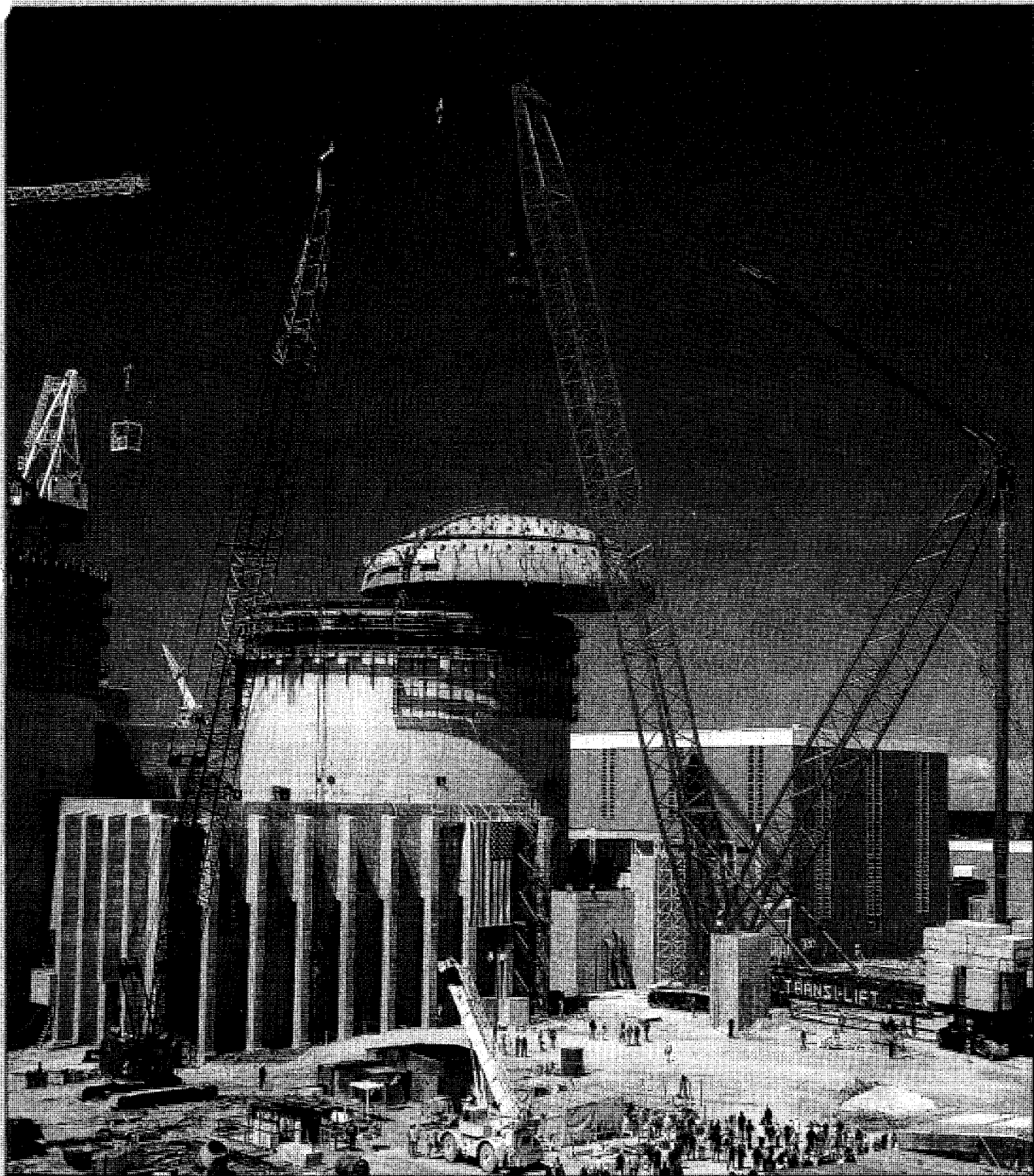

Poured concrete dome going on the containment building at the Diablo Canyon Nuclear Power Plant, Diablo Canyon, California.
Cost \$5,500,000,000.

Pipe in North America was first made from elm and hemlock trees by boring, manually of course, 5 or 10 foot logs with augurs. Or logs were split, hollowed and staved together. Limb joints were used as natural points to "branch" the pipe to a joining or outlet. In mid-17th century Boston concerted use of wooden pipeline began. For fires the line was bored into at point of need and later plugged. Cast iron pipes came into being and Philadelphia was first to replace its wooden pipes with this. The used wooden pipes were sold to the city of Burlington, New Jersey for re-use. By the 1890's wood was not up to handling the steam machinery of the times.

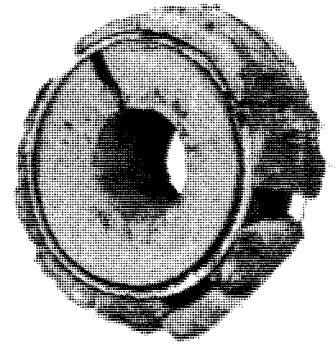

A later wrought iron process from England was further improved upon in 1832 with an iron butt welding technique similar to CW (below) at Pascal Iron Works, Philadelphia. In 1862, Robert Briggs, superintendent at Pascal, developed what came to be known as "Briggs Standard" sizing for pipe and threads 1/8" to 10". This exists to this day as Sch 40 pipe and thread patterning.

Industry advanced in 1884 with use of Bessemer steel-less costly and superior to iron-at Riverside Iron Works, Wheeling, WVa. 1890 saw the seamless process perfected. John Moon, in 1911, understood how pipe could be made continuously (CW) and in 1922 production started at the (Sam) Fretz-Moon Tube Company. By 1930 ERW came into being.

MODERN MANUFACTURING METHODS:

CONTINUOUS WELD (CW) Pipe begins as coiled strip in the required width and thickness for the size and schedule to be made. Strip is leveled and welded end to end to make "endless" ribbon loop of steel. Then a furnace flame heats to 2450° F, edges to 2600° F. Hot formed into an oval. Edges are pressed together by welding rolls making a forged weld. No metal is added in this operation. Final rolls form measurements to finished dimensions. Saw cut, descaled, inspected, tested, ends prepared.

SIZES: to 4" IPS Specifications to A-120, A-53, API 5L.

DOUBLE SUBMERGED ARC WELD (DSAW) Pipe is made from plate formed into "U" shape and bevelled; then into cylindrical shape and a "V" notch edge-forming process which fills with molten metal from weld rod. Inside seam is also welded. Expanded during manufacturing to proper size and roundness in a cold work process that also increases strength of the pipe.

SIZES: 18" to 48" Specifications to API 5L, API 5LX grades 42-65.

SPIRAL WELD Pipe has a spiral seam running its length. Welding is external and internal by submerged arc process. Size is controlled by angle and width of strip fed into welder. Made many diameters: tolerances less strict. Specifications: various.

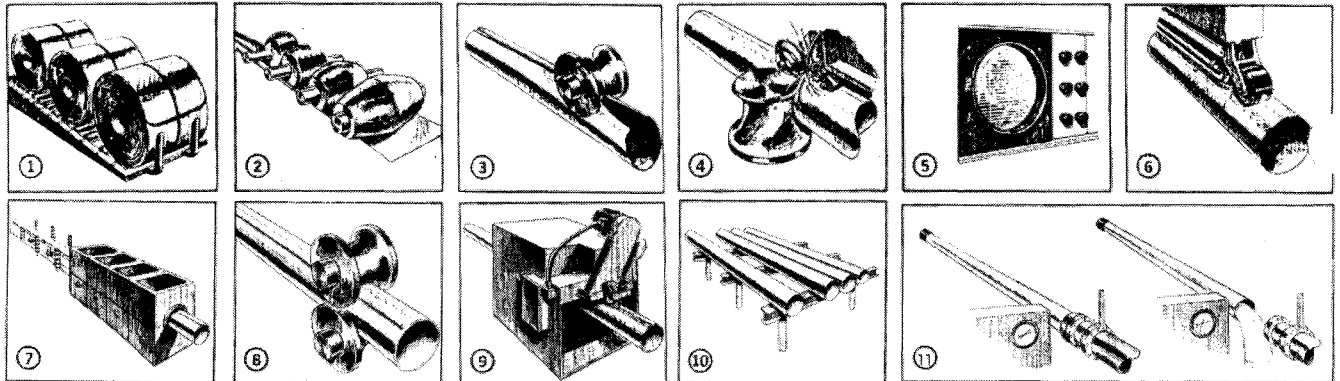

ELECTRIC RESISTANCE WELDING (ERW) 1) Coils of strip flattened, lead edge sheared. 2) Cold forming section presses strip into round. 3) Final rounding process and edge prep for electric welding. 4) Revolving copper discs serve as electrodes, edges heat to 2600°F and squeezed by pressure. No metal is added. Flash at weld is removed by cutters while still white hot. 5) Electronic check. 6) Seam normalized. 7) Weld cooled by air & water. 8) Size & straighten. 9) Cut to length. 10) Visual check. 11) Hydro test.

SIZES: 2" to 22" IPS Specifications to A-53, API 5L, API 5LX, grades 42-65.

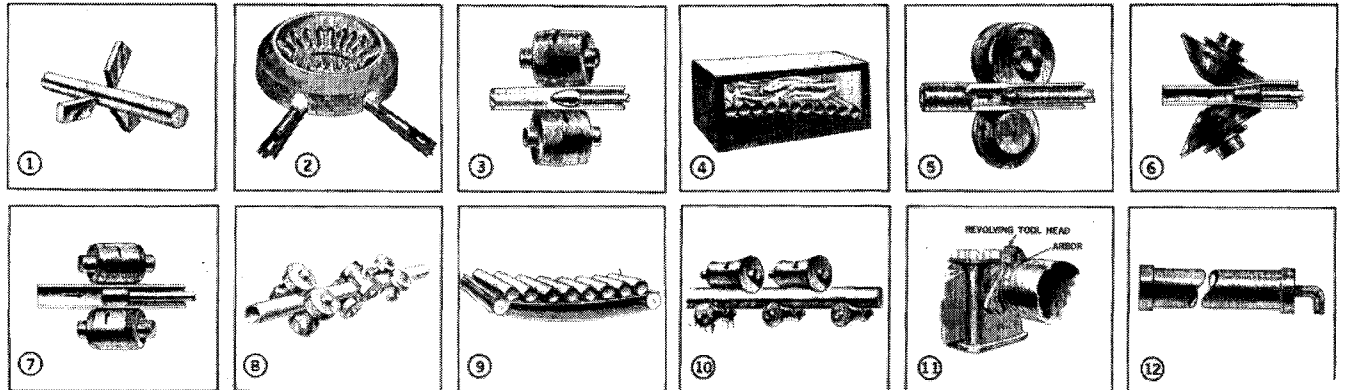

SEAMLESS 1) Deoxidized billet is machined and end centered for piercing. 2) Heat to temperature in a rotary hearth furnace. 3) Rotation over piercing point, hole through length. 4) Reheat to forging temperature. 5) Mandrell forming and length increased. 6) Pipe larger than 16" is rediametered. 7) ID and OD surfaces burnished. 8) Stretch reducing size mill for exact sizing. 9) Cooling. 10&11) Straighten, ends cropped and prepared. 12) Hydrotest. Stencil markings applied.

SIZES: 1/8" to 26" IPS Specifications to A-53, A-106, A-333, A-335 P1-22, API 5L, API 5LX, grades 42-65.

STEEL PIPE

DIMENSIONS & WEIGHTS

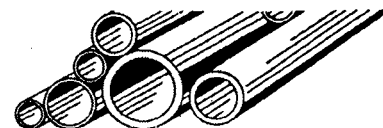

Dimensions cover black, galvanized, chromemoly, stainless, aluminum and are very close to brass, copper, coppernickel (pg. 110). For full schedule chart see pages 195 & 196. *Ordering info:* nominal size and Class or Schedule.

Nominal Size		Outside Diameter		Wall Thickness		Designations Full Listing Pg. 195		Inside Diameter		Weight	Test Pressure
Inches	mm	Inches	mm	Inches	mm	Wt. Class	Schedule	Inches	mm	Lb/ft	PSI
1/8	6	.405	10.3	.068	1.73	STD	40	.269	6.8	.24	700
				.095	2.41	XH	80	.215	5.5	.31	850
1/4	8	.540	13.7	.088	2.24	STD	40	.364	9.2	.42	700
				.119	3.02	XH	80	.302	7.7	.54	850
3/8	10	.675	17.1	.091	2.31	STD	40	.493	12.5	.57	700
				.126	3.20	XH	80	.423	10.7	.74	850
1/2	15	.840	21.3	.109	2.77	STD	40	.622	15.8	.85	700
				.147	3.73	XH	80	.546	13.8	1.09	850
3/4	20	1.050	26.7	.113	2.87	STD	40	.824	21.0	1.13	700
				.154	3.91	XH	80	.742	18.9	1.47	850
1	25	1.315	33.4	.133	3.38	STD	40	1.049	26.6	1.68	700
				.179	4.55	XH	80	.957	24.3	2.17	850
1 1/4	32	1.660	42.2	.140	3.56	STD	40	1.380	35.1	2.27	1000
				.191	4.85	XH	80	1.278	32.5	3.00	1300
1 1/2	40	1.900	48.3	.145	3.68	STD	40	1.610	40.9	2.72	1000
				.200	5.08	XH	80	1.500	38.1	3.63	1300
2	50	2.375	60.3	.154	3.91	STD	40	2.067	52.5	3.65	1000
				.218	5.54	XH	80	1.939	49.2	5.02	1300
2 1/2	65	2.875	73.0	.203	5.16	STD	40	2.469	62.7	5.79	1000
				.276	7.01	XH	80	2.323	59.0	7.66	1300
3	80	3.500	88.9	.216	5.49	STD	40	3.068	77.9	7.58	1000
				.300	7.62	XH	80	2.900	73.7	10.25	1300
3 1/2	90	4.000	101.6	.226	5.74	STD	40	3.548	90.1	9.11	1200
				.318	8.08	XH	80	3.364	85.4	12.51	1700
4	100	4.500	114.3	.237	6.02	STD	40	4.026	102.3	10.79	1200
				.337	8.56	XH	80	3.826	97.2	14.98	1700
5	125	5.563	141.3	.258	6.55	STD	40	5.047	128.2	14.62	1670
				.375	9.53	XH	80	4.813	122.3	20.78	2430
6	150	6.625	168.3	.280	7.09	STD	40	6.065	154.1	18.78	1520
				.432	10.97	XH	80	5.761	146.3	28.57	2350
7*	175	7.625	193.7	.310	7.87	STD	40	7.02	178.3	23.6	—
				.500	12.70	XH	80	6.63	168.3	38.1	—
8	200	8.625	219.1	.322	8.18	STD	40	7.98	202.7	28.55	1340
				.500	12.70	XH	80S	7.625	193.7	43.39	1670
9*	225	9.625	244.5	.342	8.69	STD	40	8.94	227.1	33.9	—
				.500	12.70	XH	80	8.63	219.2	48.7	—
10	250	10.750	273.0	.365	9.27	STD	40	10.02	254.5	40.48	1220
				.500	12.70	XH	80S	9.75	247.6	54.74	1670
11*	275	11.750	298.5	.375	9.53	STD	40	11.00	279.4	45.6	—
				.500	12.70	XH	80	10.75	273.1	60.1	—
12	300	12.750	323.8	.375	9.53	STD	40S	12.00	304.8	49.56	1060
				.500	12.70	XH	80S	11.75	298.5	65.42	1410
14	350	14.00	355.6	.375	9.53	STD	30	13.25	336.5	54.57	960
				.500	12.70	XH	-	13.00	330.2	72.09	1290
16	400	16.00	406.4	.375	9.53	STD	30	15.25	387.4	62.58	
				.500	12.70	XH	40	15.00	381.0	82.77	
18	450	18.00	457.2	.375	9.53	STD	-	17.25	438.2	70.6	
				.500	12.70	XH	-	17.00	431.8	93.5	
20	500	20.00	508.0	.375	9.53	STD	20	19.25	488.9	78.6	
				.500	12.70	XH	30	19.00	482.6	104.1	
22	550	22.00	558.8	.375	9.53	STD	20	21.25	539.8	86.6	
				.500	12.70	XH	30	21.00	533.4	114.8	
24	600	24.00	609.6	.375	9.53	STD	20	23.25	590.6	94.6	
				.500	12.70	XH	-	23.00	584.2	125.5	

* fittings no longer made these sizes except some copper nickel

PIPE

IPS - IRON PIPE SIZE STANDARD

SIZES: 1/8" to 36"

IPS pipe is available in all common materials. All IPS pipe has the same outside diameter regardless of material, schedule or class.

Lengths are standard 21' for welded steel pipe. Seamless steel pipe is manufactured in 17' to 24' random lengths. Stainless, aluminum, monel, copper, and copper nickel are in 20' lengths. Brass pipe is standard 12' (6' length if chrome plated). 20' brass lengths are also available.

Pipes can be cut to specified length or bent to specification.

Military specification pipe pg 191.

Metric and Imperial pipe and tubing pg 113 and 114.

Tube size material is itemized on pg 111.

Complete IPS dimension charts on pg 195 and 196.

		WELDED	SEAMLESS
Steel Black	STD/40	770040	771040
	XH/80	770080	771080
	SCH 160	770160	771160
	XXH	770088	771088
Galvanized	STD/40	772040	773040
	XH/80	772080	773080
Stainless 304	SCH 10	767010	767110
	STD/40	767040	767140
	XH/80	767080	767180
Stainless 316	SCH 10	768010	768110
	STD/40	768040	768140
	XH/80	768080	768180

		SEAMLESS	Pipe Size Rule
Bondstrand®/FRP	pg 100	702000	
Brass B-42	STD/40	741040	—REF MARK—
	XH/80	741080	
ChromePlatedBrass	STD/40	741140	1/4" —O.D. .540—
	STD/40	751040	3/8" —O.D. .675—
	XH/80	751080	1/2" —O.D. .840—
Copper B-43	CL 200	710200	3/4" —O.D. 1.050—
	STD/40	710040	
	XH/80	710080	
CopperNickel 90/10 B466	CL 200	720200	1" —O.D. 1.315—
	CL 700	720700	
	STD/40	720040	1 1/4" —O.D. 1.660—
CopperNickel 70/30 B466	XH/80	720080	1 1/2" —O.D. 1.900—
Deoxidized Copper	—	731000	2" —O.D. 2.375—
	STD/40	762040	
	XH/80	762080	
Aluminum 6061	STD/40	764040	3" —S80 I.D. 2.900—
	XH/80	764080	—S40 I.D. 3.068—
			—O.D. 3.500—
Aluminum 5086	STD/40	769010	
	XH/80	769040	
Monel (NiCu)	SCH 10	791040	4" —S80 I.D. 3.826—
	STD/40	791080	—S40 I.D. 4.026—
	XH/80	792040	—O.D. 4.500—
Chromemoly P11 Steel	STD/40	792080	
	XH/80		
Chromemoly P22 Steel	STD/40		
	XH/80		

NOTE: Thin wall Sch 5 or 10 IPS and Cl 200 or 700 pipe is not suitable for use with threaded fittings.

COPPERNICKEL AND COPPER IPS DIAMETERS WITH THIN WALL

IPS SIZE	OD	CopperNickel		Deox Copper
		Class 200	Class 700	Hard Drawn Wall
		90/10 70/30 Wall	70/30 Wall	
1/8	.405	.065	—	.065
1/4	.540	.065	.065	.065
3/8	.675	.065	.072	.065
1/2	.840	.065	.072	.065
3/4	1.050	.065	.083	.065
1	1.315	.065	.095	.065
1 1/4	1.660	.072	.095	.065
1 1/2	1.900	.072	.109	.065
2	2.375	.083	.120	.065
2 1/2	2.875	.083	.134	.065
3	3.500	.095	.165	.065
3 1/2	4.000	.095	.180	.065
4	4.500	.109	.203	.065
5	5.563	.125	.220	.095
6	6.625	.134	.259	.095
8	8.625	.148	.340	.105
10	10.750	.187	.380	.131
12	12.750	.250	.454	—

RED BRASS B-43, COPPER B-42 COPPERNICKEL B-466 IPS Diameter With STD and XH Wall

IPS SIZE	OD	STD Sch 40 Wall	XH Sch 80 Wall
1/8	.405	.062	.100
1/4	.540	.082	.123
3/8	.675	.090	.127
1/2	.840	.107	.149
3/4	1.050	.114	.157
1	1.315	.126	.182
1 1/4	1.660	.146	.194
1 1/2	1.900	.150	.203
2	2.375	.156	.221
2 1/2	2.875	.187	.280
3	3.500	.219	.304
3 1/2	4.000	.250	.321
4	4.500	.250	.341
5	5.563	.250	.375
6	6.625	.250	.437

STAINLESS STEEL 304, 316, A20

IPS SIZE	OD	Sch 5 Wall	Sch 10 Wall	STD Sch 40 Wall	XH Sch 80 Wall
1/8	.405	.035	.049	.068	.095
1/4	.540	.049	.065	.088	.119
3/8	.675	.049	.065	.091	.128
1/2	.840	.065	.083	.109	.147
3/4	1.050	.065	.083	.113	.154
1	1.315	.065	.109	.133	.179
1 1/4	1.660	.065	.109	.140	.191
1 1/2	1.900	.065	.109	.145	.200
2	2.375	.065	.109	.154	.218
2 1/2	2.875	.083	.120	.203	.276
3	3.500	.083	.120	.216	.300
3 1/2	4.000	.083	.120	.226	.318
4	4.500	.083	.120	.237	.337
5	5.563	.109	.134	.258	.375
6	6.625	.109	.134	.280	.432
8	8.625	.109	.148	.322	.500
10	10.750	.134	.165	.365	.500
12	12.750	.165	.180	.406	.500

COPPER TUBE INCH & METRIC

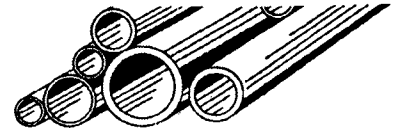

COPPER WATER TUBING ASTM B88

SIZES: 1/8" to 6" and 4mm to 54mm

DESIGN DESCRIPTION

Copper tube is made either hard or soft. Inch standard is designated type K, L, M, ACR, Refrigeration, or Heavy, depending on wall thickness and execution. With K,L,M tubing actual outside diameter is larger than nominal or "name" size.

Type K - supplied hard 20' lengths or soft 60' coils - is recommended for general plumbing and is also suitable for gas, oil, and low pressure steam.

Type L - supplied hard 20' lengths or soft 60' coils - is recommended for interior applications in plumbing and heating.

Type M - supplied hard 20' lengths - is for non-pressurized uses with solder fittings only.

ACR Grade - supplied hard 20' lengths - Has I.D. cleaned and ends capped for air conditioning and refrigeration use.

REFRIGERATION COIL - soft 50' coils - is also "cleaned and capped".

HEAVY COPPER COIL - soft 50' coils - is general purpose extra heavy wall tube. Ends are open.

METRIC COPPER TUBE - hard 5-6 meter lengths, soft 10 meter coils - is specified by O.D. and wall thickness.

Bronze Solder Joint - SJ - valves and wrought copper SJ fittings are designed for soldering onto copper tubes. (Bite type flareless compression and flare end fittings are also sized for these tubes).

Bronze Silbraz - SB - valves and fittings are designed for brazing to copper, red brass or copper-nickel pipe and have ends sized to accommodate pipe outside diameters (also called IPS sized).

IMPORTANT NOTE: The term "sweat" is used to describe the joining technique for both solder joint (tube size) materials and silbraz (IPS pipe size) materials. Actual O.D. of tube or I.D. of valves or fittings will establish which type is referred to when "sweat" connection is indicated.

All available Chrome Plated. Order with CP after Part #.

NOM SIZE	Actual OD	Type K 752000 Wall	Type L 753000 Wall	Type M 754000 Wall	ACR 755000 Wall
1/4	3/8	.035	.030	.025	.030
3/8	1/2	.049	.035	.025	.035
5/8	3/4	.049	.040	.028	.040
3/4	7/8	.065	.045	.030	.042
1	1 1/8	.065	.050	.035	.050
1 1/4	1 3/8	.065	.055	.042	.055
1 1/2	1 5/8	.072	.060	.049	.060
2	2 1/8	.083	.070	.058	.070
2 1/2	2 5/8	.095	.080	.065	.080
3	3 1/8	.109	.090	.072	.090
3 1/2	3 5/8	.120	.100	.083	.100
4	4 1/8	.134	.110	.095	.110
5	5 1/8	.160	.125	.109	.125
6	6 1/8	.192	.140	.122	.140

METRIC COPPER TUBING

NOM Size	Actual OD	5-6 Meter Lgths Plain Finish 873000 Wall	2 Meter Lgths Chrome Plate 874000 Wall	10m Soft Coil Plain Chrome 800000 800001 Wall
4	4	0.8		0.8
6	6	0.8	1.0	0.8
8	8	0.8	1.0	0.8
10	10	0.8	1.0	1.0
12	12	1.0	1.0	1.0
14	14	1.0		1.0
15	15	1.0	1.0	1.0
16	16	2.0		1.0
18	18	1.0		1.0
20	20	2.0		-
22	22	1.0		1.0
25	25	2.0		
28	28	1.2		
35	35	1.5		
42	42	1.5		

* Note: Other walls available

COPPER REFRIGERATION COILS

NOM Size	Actual OD	Standard 761000 Wall	Heavy 761001 Wall
1/8	1/8	.030	.065
3/16	3/16	.030	.065
1/4	1/4	.030	.065
5/16	5/16	.032	.065
3/8	3/8	.032	.065
1/2	1/2	.032	.065
5/8	5/8	.035	.065
3/4	3/4	.035	.065
7/8	7/8	.045	
1 1/8	1 1/8	.050	
1 3/8	1 3/8	.055	
1 5/8	1 5/8	.060	

PRESSURE TUBING

MATERIAL: Carbon Steel Welded or Seamless
Stainless Steel 304 Welded or Seamless
316 Welded or Seamless

For use with flareless compression/Bite/Lok type fittings or flare fittings (pg 101) or tube socket weld fittings (pg 91). Mounting clamps (pg 103). Metric (pg 113).

ORDERING INFO: Material + OD + Wall Thickness + Welded or Seamless

SIZES (OD)	1/4	5/16	3/8	1/2	5/8	3/4	7/8	1	1 1/8	1 1/4	1 1/2	2
Common walls	.035-.049	.035	.035	.035	.035	.035	.035	.049	.035	.065	.065	.065
Standard length 20"	.065	.065	.065	.065	.065	.065	.065	.083	.095	.120	.120	.188

W & O SUPPLY INC

CONDENSER AND HEAT EXCHANGER TUBES

We maintain stocks in a variety of types, sizes, and materials/alloys for immediate cut-to-length and ship-fast requirements. Tubes to ASTM B111.

In addition we offer complete manufacture or repair of tube bundles, tube sheets, baffles, air coolers, heat exchangers and condenser units. Shopwork is ASME Code Certified: R 2233.

MATERIALS:		COMPOSITION:				
CopperNickel 90/10	Alloy 706	Cu 88.75	Ni 10	Iron 1.25		
70/30	Alloy 715	Cu 69.5	Ni 30	Iron .05		
Admiralty Bronze	Alloy 443	Cu 71	Tn 1	Zinc 28.0	Arsenic .03	
	Alloy 444	Cu 71	Tn 1	Zinc 28.0	Arsenic .03	
Aluminum Brass	Alloy 687	Cu 77	Al 2	Zinc 21.0		
De-Oxided Copper	Alloy 122	Cu 99.9min		Phos .02		

SIZES: OD x BWG Gauge All types and sizes cut to length
 Gauges not listed can be supplied as ordered
 Metrically dimensioned tubes available

Common Sizes:			Typical Length 20' and 24'
OD	Gauge	Wall	
1/4	20	.035	"
3/8	20	.035	"
3/8	18	.049	"
1/2	18	.049	"
1/2	16	.065	"
5/8	18	.049	Typical Length 33'
5/8	16	.065	"
3/4	20	.035	"
3/4	18	.049	"
3/4	16	.065	"

Available styles include integral finned tube, high finned tube with fins brazed, soldered, diffusion clad or tension mounted, and turbolater internal finned tube.

Tube plates or tube sheets and baffles in CopperNickel, Naval Bronze, Stainless: all types and sizes made.

Tube Expander Tool: to order specify tube OD and wall, or tube ID and depth of roll or tube sheet thickness.

Tube plugs in Brass, Steel, Stainless, Monel: specify tube ID.

BOILER TUBE

MATERIAL: Carbon Steel to ASTM A178 Welded
 A192 Seamless

Common Sizes:			Typical Length:
OD	BWG	Wall	
1, 1 1/4, 1 1/2	16 Ga	.065"	17' to 22' random or
	14 Ga	.083"	22' to 27' random or
	12 Ga	.103"	cut to length
2	12 Ga	.103"	"
	10 Ga	.134"	"
	9 Ga	.148"	"
2 1/4, 2 1/2	12 Ga	.103"	"

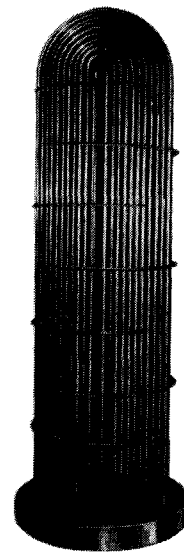

Tube Bundle
Standard Tubes

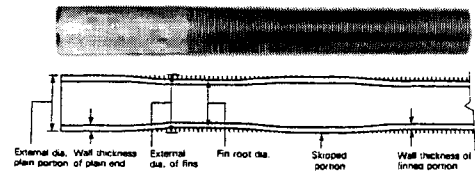

Integral Low Finned Tube

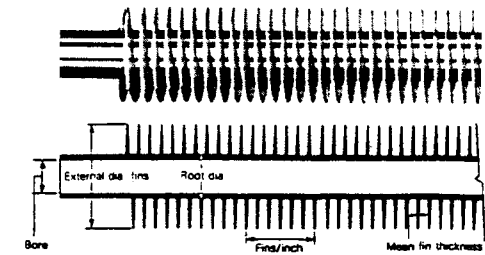

High Finned Tube

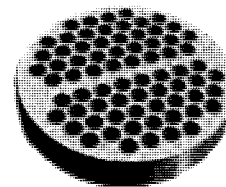

Tube Sheet



Tube Expander Tool



Cleaning Brush

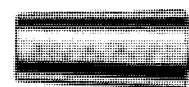

Tube Plug

METRIC TUBING

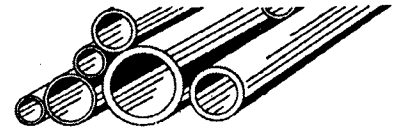

Fittings listed on page 102, 139

STEEL HYDRAULIC TUBING DIN 2391 CLASS C 6 Meter Lengths - Fig 871000 Specify OD + Wall

OD mm	4	6	8	10	12	14	15	16	18	20	22	25	28	30	35	38	42
Light Wall	0.5	1.0	1.0	1.0	1.5	2.0	1.5	2.0	1.5	2.0	1.5	2.5	2.0	2.5	3.0	3.0	3.0
KG/CM ²	242	322	242	193	242	276	193	242	161	193	132	193	138	161	166	153	132
Med. Wall	.75	1.5	1.5	1.5	2.0	2.5	2.0	2.5	2.0	2.5	2.0	3.0	3.0	3.0	4.0	4.0	4.0
KG/CM ²	363	483	363	280	322	345	258	302	215	242	176	232	207	193	221	204	185
Hvy. Wall	1.0	2.0	2.0	2.0	2.5	3.0	2.5	3.0	2.5	3.0	2.5	4.0	4.0	4.0	5.0	5.0	5.0
KG/CM ²	483	644	483	387	403	414	322	363	269	290	220	309	276	258	276	234	230

KG/CM² = operating pressure, based on 4 to 1 safety factor

STAINLESS TUBING DIN 2343 5-6 Meter Lengths - Fig 877000

OD mm	6	8	10	12	14	15	16	18	20	22	25	30	35	38
Light Wall	1.0	1.0	1.5	1.5	1.5	1.5	1.5	1.5	1.5	1.5	2.5	2.5	2.5	2.5
KG/CM ²	411	328	370	318	250	235	220	196	172	156	188	196	168	155
Med. Wall		1.5	2.0	2.0			2.0	2.0	2.0	2.0	2.5			
KG/CM ²		460	496	401			348	313	288	249	263			

COPPER TUBING - Hard Drawn Straight 5-6 Meter Lengths - Fig 873000 1-2 Meter Lengths - Fig 874000 Chrome plated

OD mm	6	8	10	12	14	15	16	18	20	22	25	28	35	42	54	67
Typical Wall	.08	.08	.08	1.0	1.0	1.0	2.0	1.0	2.0	1.0	2.0	1.2	1.5	1.5	1.8	1.8
KG/CM ²			78	71		57		48		38						

Note: Other walls available

COPPER TUBING - Soft Coils 10 Meter Coils - Fig 900000 Fig 900000C - Chrome plated

OD mm	4	6	8	10	12	15	16	18	22
Wall	0.8	0.8	0.8	1.0	1.0	1.0	1.0	1.0	1.0
								1.5	1.5
KG/CM ²	148	112	85	87	71	57	53	48/72	38/58



METRIC AND IMPERIAL TUBING AND FITTINGS

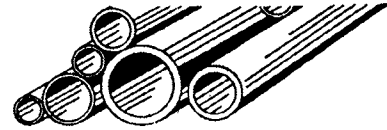

To BS 2871 Part 2

SIZES: 6mm to 508mm **METRIC**
1/2" to 24" **IMPERIAL (not IPS)**

Aluminum Brass 76/22/2 also known as "Yorcalbro"
(ASTM B111, CZ 100) and

CopperNickel 90/10 also known as CopperNickel Iron
(ATSM C70600, CN 102).

Aluminum brass has broad application in fuel oils and chemical service.
Coppernickel is used especially for bitumen type cargo systems or as an
upgrade for aluminum brass. Both are supplied in annealed temper.

Fittings for these piping systems are available in several types. Socket end
silver brazing fittings (shown) are supplied in aluminum brass with preinserted
silver brazing or capillary ring in small sizes (through 44.5 MM or 2"). Larger
fittings are gunmetal alloy LG2C. See pg 104 for a fuller description of fittings.

Buttweld fittings in aluminum brass or coppernickel are made in sizes above
44.5 mm or 2". Specify or add "BW" suffix to part numbers.

Tanker unions (shown below) offer a mechanical connection of two tubes
without requiring high heat that brazing or welding would require. This
mechanical connection is commonly used to repair tanker heating coil
systems where high heat would be ill advised. See pg 104.

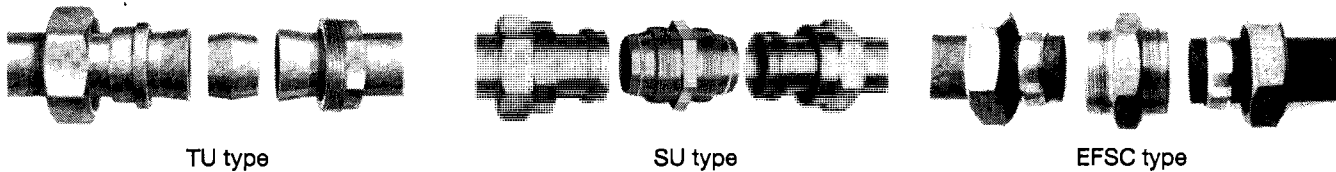

DIMENSIONS: Common Sizes and Walls*

METRIC SERIES (mm) Aluminum Brass (875000) and Coppernickel (875100)

Tube Size = Outside Diameter:	mm	6	8	10	12	16	20	25	30	38	44.5	57	76.1	88.9	108	133	159
Wall Thickness:	mm	0.8	0.8	0.8	0.8	1.0	1.0	1.5	1.5	1.5	1.5	2.0	2.0	2.5	2.5	2.5	2.5

IMPERIAL SERIES (Inches) Aluminum Brass (875001) and Coppernickel (875101)

Nominal Bore =	Inside Diameter:	1/2	3/4	1	1 1/4	1 1/2	2	2 1/2	3	3 1/2	4	5	6	
	Outside Diameter:	.596	.846	1.11	1.36	1.61	2.13	2.63	3.14	3.66	4.184	5.184	6.208	In
	mm:	15.1	21.5	28.2	34.6	40.9	54.0	66.7	79.8	93.0	106.27	131.67	157.68	mm
	Wall:	.048	.048	.056	.056	.056	.064	.064	.072	.080	.092	.092	.104	In
	mm:	1.22	1.22	1.42	1.42	1.42	1.63	1.63	1.83	2.03	2.34	2.34	2.64	mm
	Gauge:	18	18	17	17	17	16	16	15	14	13	13	12	SWG

Note: Other walls available for both Imperial and Metric
*Specify service pressure, temperature and medium.

EXPANSION JOINTS

Joints are available in a variety of styles for different service application requirements. Types are identified and described below. Flange drilling to ANSI and metric - please indicate drilling pattern dimensions. Movement patterns are shown below, and measure and degree of these actions as well as temperature must be considered for suitable choice of joint construction.

RUBBER BELLOWS or SPOOL PIECE TYPE

Function well to prevent line stress or accomodate misalignment. Also for noise and vibration dampening. For general economy service, to 240°F and 225 PSI: construction of molded neoprene and nylon with floating solid plate steel flanges, 6" overall length. Tapped boltholes.

For more specialized applications please specify medium conveyed in line so that proper casing material can be determined. Also movement dynamics, pressure or vacuum and temperature ranges. This type known as spool piece type has integral elastomer flanges and split steel retaining rings. Generally 6"-8" length with single arch, or 10"-12" with double arch. Control rod option for excessive elongation situations.

U-TYPE TUBULAR RUBBER ABSORBER

Non-arched rubber vibration and sound absorber good also for some lateral movement with molded rubber flanged ends or crimp-on nipple ends. Comes standard lengths 12"-36".

METAL BELLOWS TYPE

Bellows material is 321SS. Can be supplied sleeve-lined for temperature/pressure applications, or for flow considerations. Weld stub end or flange is typically carbon steel. End to end dimension to your specification. Please indicate description of movement dynamics, pressure/temperature ranges and medium conveyed in the line. With control rods as needed.

BRAIDED PUMP CONNECTION TYPE

Construction from flexible annular corrugated hose of stainless or tin-bronze tubing with cover mesh for strength. Flanged, weld stub or threaded ends.

TEFLON BELLOWS

Teflon construction for wide application in chemical process. Short overall length: 2"-3". Ductile iron flanges with tapped boltholes.

SLIP TUBE TYPE

Precision machined and lubricated slip joint bolts rigid into pipeline. Designed to accomodate extreme traverse (on-line movement); supplied with or without base. Traverse 4" or 8" maximum, single or double joint.

MOVEMENT PATTERN PROFILES:

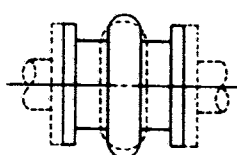

Axial Compression

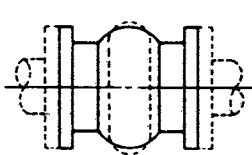

Axial Elongation

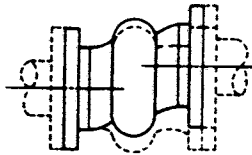

Lateral Movement

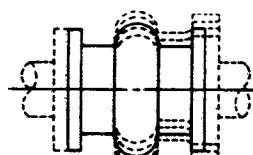

Vibration

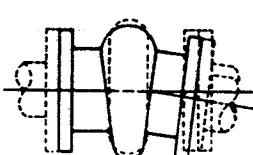

Angular

W & O SUPPLY INC

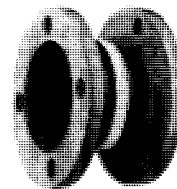

Economy Sphere Bellows



Rubber Bellows Spool Piece



U-Type Absorber

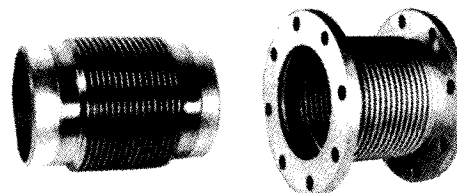

Metal Bellows Weld Stub & Flanged

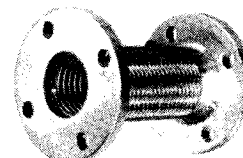

Flexible Pump Connector



Teflon Expansion Joint

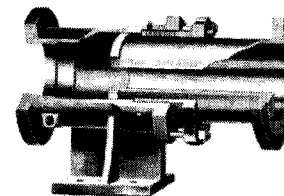

Slip Tube Type shown with base

PIPE HANGERS AND CLAMPS

SIZES: 1/4" to 24"

Common Materials:

Steel - figure numbers below

Galvanized Steel - add "G"

Stainless Steel - add "SS"

Pro-Loc® & Nelson® pg 192



Pipe Clamp 212
548212

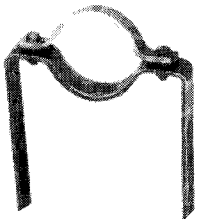

Chair Clamp 100
548100

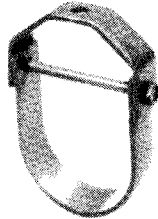

Clevis Hanger 260
548260



Spring Hanger
548247

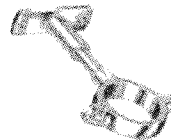

Wall Standoff
548895

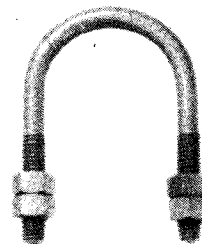

U-Bolt
548137



Riser Clamp
548261



Offset Clamp
548103

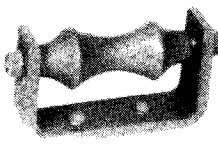

Roller Hanger
548175

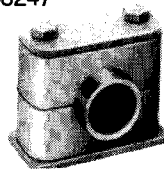

Stauff® Type Tube Support
Single 548801
Double 548802



Strap Clamp
548262

PIPE WELD BACKING RINGS

SIZES: 1/4" to 12"

These rings maintain gap between weld joints in pipe and fittings. They are also called consumable rings as they become part of the weld and add reinforcement to inside seam. Tips are knocked off after welding.

As these fit inside pipe joint, specify pipe size & schedule or ID.

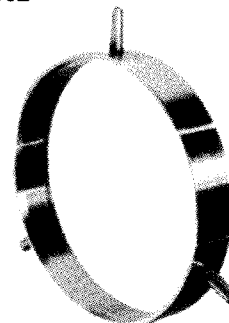

Std Steel 549980
XH Steel 549981
Sch 10 Stainless 549971
Sch 40 Stainless 549974
90/10 Coppernickel 549990

PIPE INSULATION

Calcium silicate insulation with service jacket and self-seal lap. For use to 1200°F/650°C. Various thicknesses: please specify service temperature.

Fiberglass pipe covering insulation, self-seal lap, to 850°F/455°C.

Woven fiberglass protection covering, also called stevens cloth, for blanket-making or for use with adhesive mastic as cover wrap. 60" wide roll.

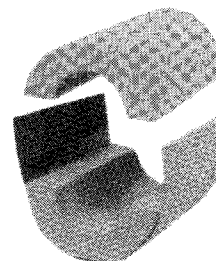

TEST PLUGS & FLEX COUPLINGS

Re-usable test plug, inserts into pipe permitting back pressure check.

Flexible coupling with hose clamps for economical pipe repair or coupling.



Test Plug



Flex Coupling

PIPE COUPLINGS

DRESSER/DIACOUP

SIZES: 1/2" to 36" IPS

Style 38 (Standard Length) and 40 (Long) couplings are available for all sizes of IPS sized pipe. Constructed of steel mid-ring and followers with resilient gaskets and steel tightening bolts. Also available in all stainless construction or galvanized steel, given lead time. Dresser type couplings can also be supplied for imperial and metric piping standards and OD pipe or tubing.

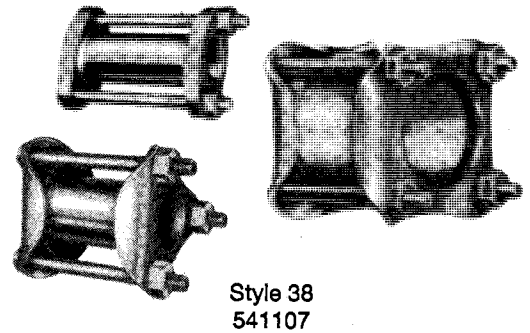

Style 38
541107

Gaskets are offered in a variety of resilient materials:

Grade 27 - Buna-S rubber for water service, max. temp. 212°F

Grade 42 - Buna-N rubber for oil and gas, max. temp. 150° F

Grade 27 armored - similar to plain Grade 27 gasket, but with brass helical coil embedded in tip of gasket to provide durable seal for critical service applications

Grade 42 armored - similar to plain Grade 42 gasket, but with brass helical coil embedded in tip of gasket to provide durable seal for critical service applications

Viton - For aromatic (eg. gasoline) service and/or high temperature (300°)

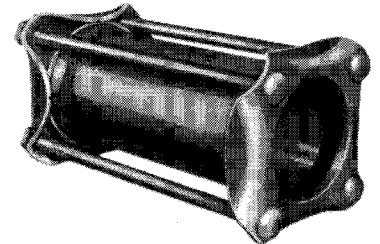

Style 40
541108

Size IPS	1	1 1/4	1 1/2	2	2 1/2	3	3 1/2	4	5	6	8	10	12	14	16	18	20	22	24	30	36
Pipe OD	1.31	1.66	1.90	2.38	2.88	3.5	4.0	4.5	5.56	6.63	8.63	10.75	12.75	14	16	18	20	22	24	30	36

Mid Ring Length: Style 38/541107

inches	5	5	5	4 5/7	5	4 5/7	4 5/7	4 5/7	4 5/7	4 5/7	4 5/7	5 7/8	5 7/8	7	7	7	7	7	7	7 10/16	7 10/16
weight	4	4	5	7	19	14	18	17	24	26	32	49	56	60	70	75	83	95	105	120	223

Mid Ring Length: Style 40/541108

inches	12	12	12	12	12	12	12	16	16	16	16	16	16	16	16	16	24	16	16/24	—	—
weight	6	9	10	15	20	23	25	28	41	51	63	78	93	133	173	176	192	224	240	—	—

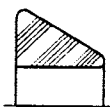

Plain
Replacement
Gaskets

GR 27 - Plain
GR 42 - Plain
GR 27 - Armored
GR 42 - Armored

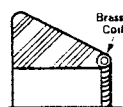

Armored
Gaskets
Replacement

541112
541110
541113
541111

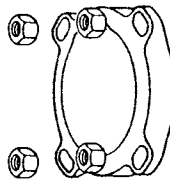

Follower
Ring

Specify
Pipe Size

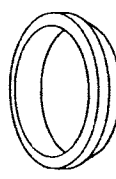

Gasket

Specify
as at left

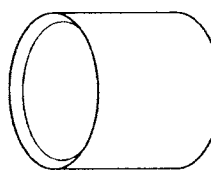

Mid
Ring

Specify
Pipe Size
and Ring
Length

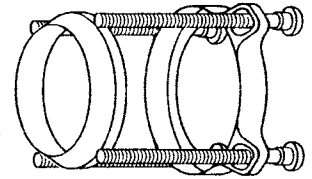

Trackhead
Bolt

Steel - 541115
Stainless - 541117
Specify Bolt Length
or Coupling Size

DECK SLEEVE

PENETRATION

SIZES: 1/2" to 16" IPS

Steel, stainless steel or copper nickel construction to be welded into place. Allows pipe a sleeved penetration of deck or bulkhead. Typical length is 3 1/4". Order by pipe size.

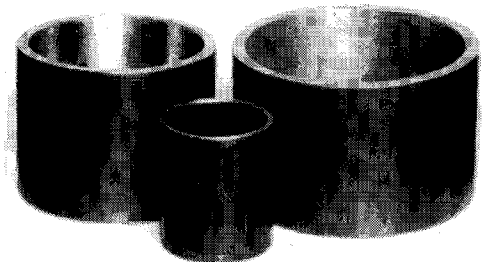

Steel 549999
Stainless 549998
Coppernickel 601555

NORMACONNECT®

PIPE COUPLINGS

SIZES: 1" to 14"
25mm to 350mm

Compact design, stainless steel body joining and repair clamps with rubber seal in conjunction with metal bite grip which provides axial restraint. Flex type - without bite teeth - is available for appropriate applications as are segmented or open body style for encirclement of a complete line. Stainless hardware to 8". Available with EPDM liner for water service (-22°F to 212°F) or Buna-N (NBR) liner for gas or oil lines (-10°F to 180°F).

Specify pipe size or O.D.

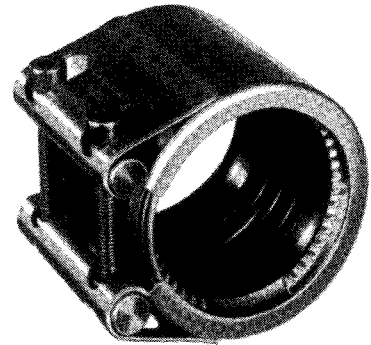

Grip Type 541101
Flex Type 541102

COMPRESSION

COUPLINGS

SIZES: 3/8" to 3"

Non-weldable compression couplings offer an economical method for joining two pipes. Rubber sleeve/gasket is sealed against the pipe by tightening the end nut. Available in black iron, galvanized iron, brass, and PVC. Brass available both pipe and tube sizes. Some 90°, 45° and tees available.

Size IPS	3/8	1/2	3/4	1	1 1/4	1 1/2	2	2 1/2	3
Short Length	2 1/2	2 5/8	2 3/4	3 1/8	3 1/4	3 3/8	3 5/8	4 3/8	4 3/4
Long Length	—	4 1/4	5	5 5/8	6	6 3/4	6 3/4	—	—

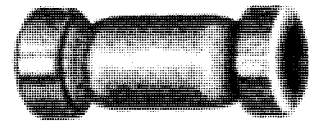

Black	(long)	541001
Galvanized	(long)	541003
	(short)	541004
Brass	(pipe)	541005
	(tube)	541006
PVC		541008
CPVC		541009

DECK / BULKHEAD

COUPLING

SIZES: 1/4" to 4"

Weldable deck / bulkhead penetration couplings with compression nut and rubber washer on one end provide seal around penetrating pipe. Double nut design joins pipes from each side of deck / bulkhead. Available in steel or aluminum.

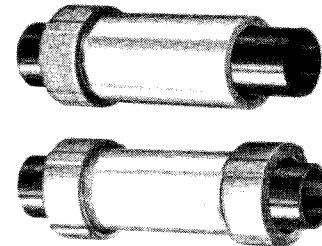

Aluminum	Single Nut	549995
	Double Nut	549996
Steel	Single Nut	549997
	Double Nut	549998

REPAIR CLAMP

SIZES: 1/2" to 24" Repair
2" to 14" Full encirclement

Repair clamps are used to repair holes or leaks in pipe. Typical economical style is stainless steel band type with rubber sleeve. Sizes refer to IPS size of pipe to be repaired. Lengths are standard 3" or 6", though longer lengths 9" and 12" are available.

Encirclement type will hold 360° repair and is a more costly unit. Width typically 8", 10"; Wider to 16" available.

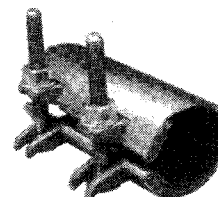

Repair
3" Width 54110
6" Width 541106

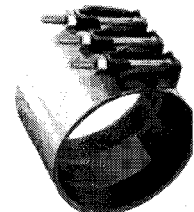

Encirclement
8" Width 541118
10" Width 541119

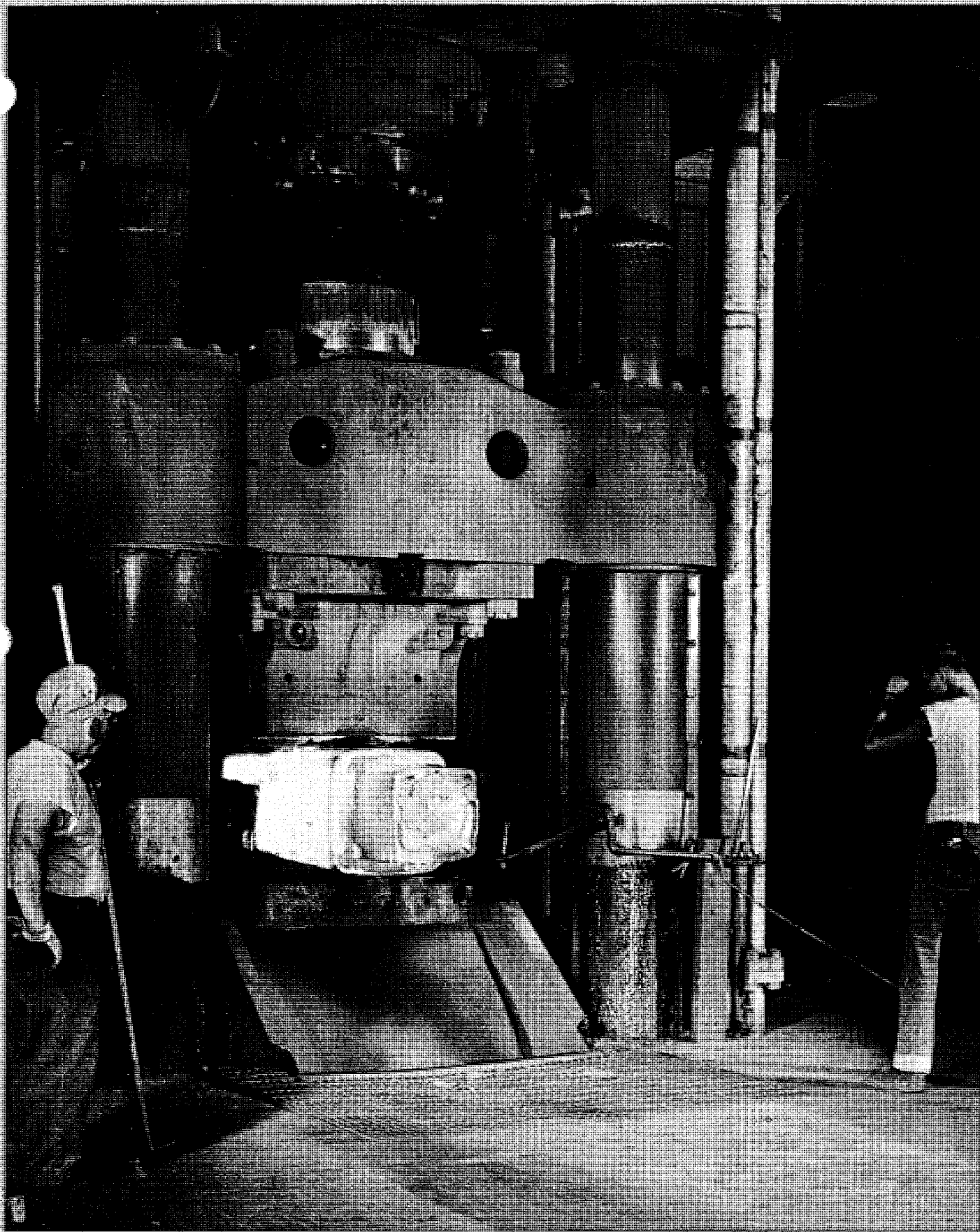

Metal Forge: the energy of a falling weight develops the pressure needed for deforming metal blanks. A forging press can be operated with steam, air, hydraulic or electric power

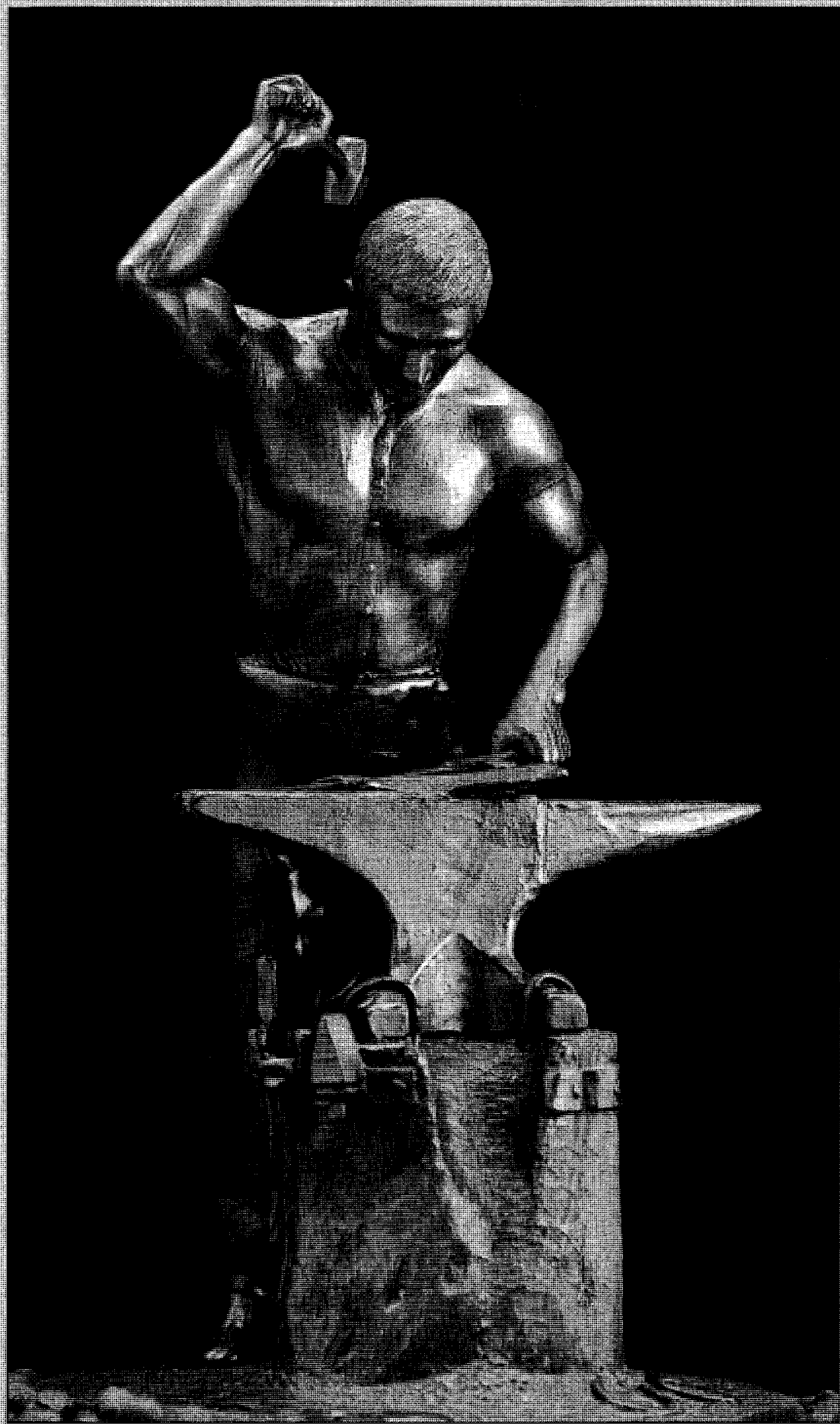

METALS: SAMPLES

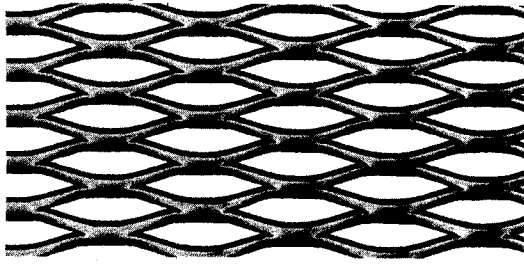

1/4 - 20 Expanded

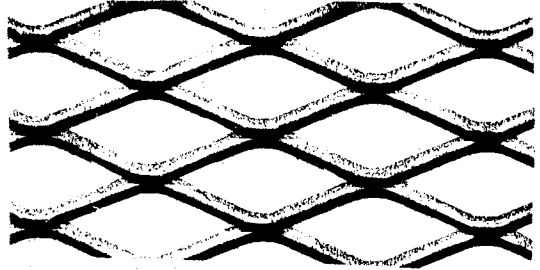

1/2 - 13 Expanded

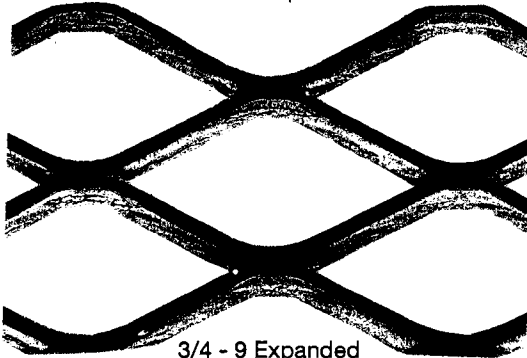

3/4 - 9 Expanded

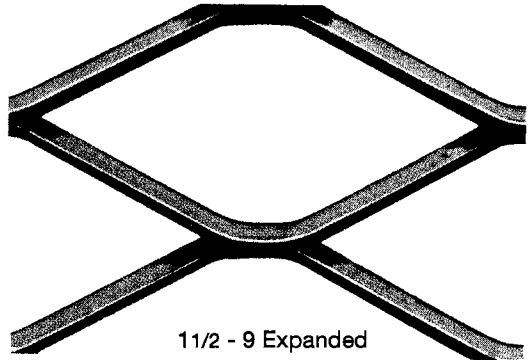

1 1/2 - 9 Expanded

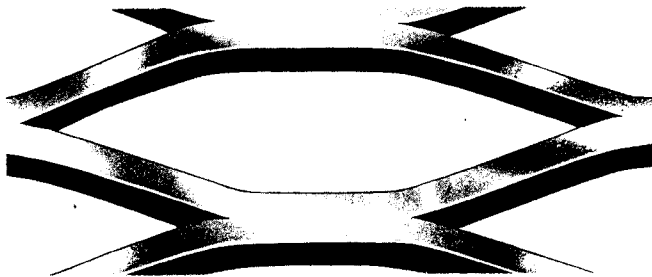

4.27# Expanded Grating

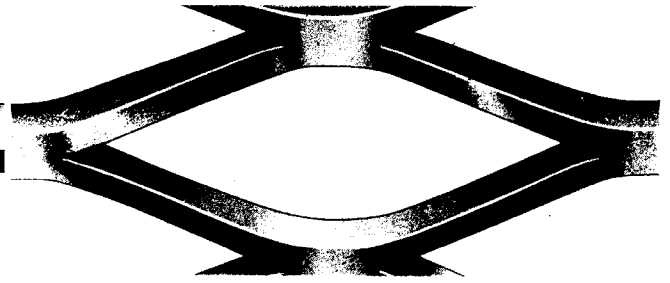

4.0# Expanded Grating

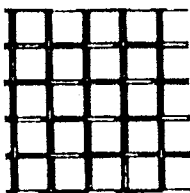

5 Mesh
77% OA
.156" Open

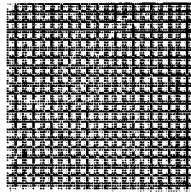

20 Mesh
52% OA
1/32" Open

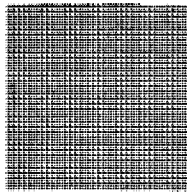

40 Mesh
36% OA
1/64" Open

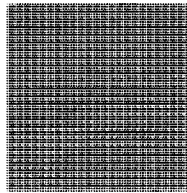

60 Mesh
30% OA
.009 Open

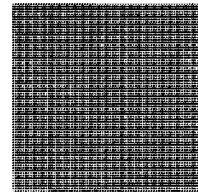

80 Mesh
31% OA
.007 Open

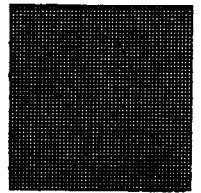

100 Mesh
30% OA
.005 Open

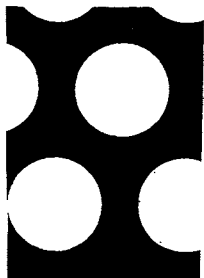

1/2 on 11/16c Perf
48% Open area

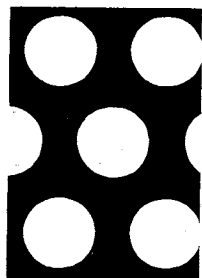

3/8 on 9/16c Perf
40% Open area

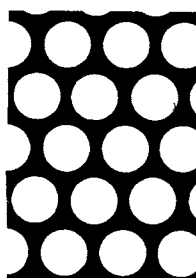

1/4 on 5/16c Perf
58% Open area

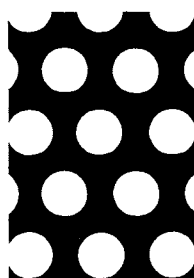

1/4 on 3/8c Perf
40% Open area

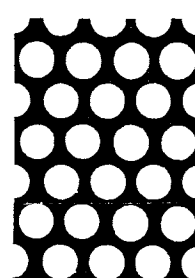

3/16 on 1/4c Perf
51% Open area

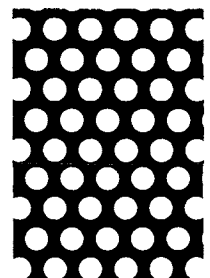

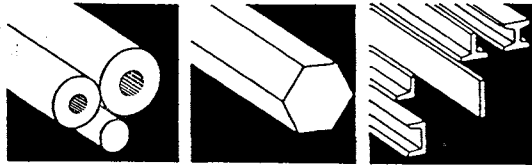

1/8 on 3/16c Perf
40% Open area

METALS: PROFILES SHAPES BARS

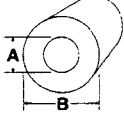

Any diameters; cut lengths also provided

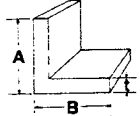
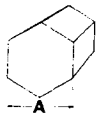
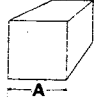
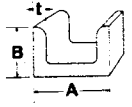
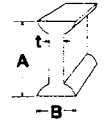
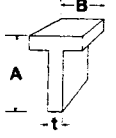
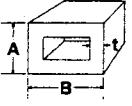
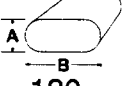
	Round	Steel + Alloy 20' Stainless 12' Brass 360 12' Bronze 660 Bearing 105" Bronze 464 Naval 12' Bronze 954 Alum 105"	Zinc Anode 3' Aluminum 12' Teflon 3' Coppernickel 90/10 12' Coppernickel 70/30 12' Copper 110 6'	
	Hollow Core	Steel + Alloy Any length Stainless Any length Bronze 660 Bearing Al Brz 954 Ampco® 18	Various OD/ID combinations: please specify choice	
	Flat	Steel 20' Stainless 12' Brass 12' Aluminum 12'	A B 1/8 x 1/2, 3/4, 1, 1 1/4, 1 1/2, 2, 2 1/2, 3, 3 1/2, 4, 5, 6 3/16 x same as above 1/4 x same as above 5/16 x 1 and wider 3/8 x 1 and wider 1/2 x 1 and wider 5/8, 3/4, 1 x 2 and wider	
	Oval	Aluminum 12'	3/16 x 1	
	Angle	Steel 20' Stainless 20' Brass 12' Aluminum 25'	A B t 1/2 x 1/2 x 1/8 3/4 x 3/4 x 1/8 1 x 1 x 1/8, 3/16, 1/4 1 1/4 x 1 1/4 x 1/8, 3/16, 1/4 1 1/2 x 1 1/2 x 1/8, 3/16, 1/4	2 x 2 x 1/8, 3/16, 1/4, 5/16, 3/8 2 1/2 x 2 1/2 x 3/16, 1/4, 5/16, 3/8, 1/2 3 x 3 x 3/16, 1/4, 5/16, 3/8, 1/2 4 x 4 x 5/16, 3/8, 1/2, 5/8, 3/4 4 x 4 x 1/4 Avail in SS + Alum
	Hex	Steel 12' Stainless 12' Brass 360 12' Bronze 464 12'	1/8, 1/4, 5/16, 3/8, 1/2, 9/16, 5/8, 11/16, 3/4, 7/8, 15/16, 1 1/16, 1 1/8, 1 1/4, 1 3/8, 1 1/2, 1 3/4, 2	
	Square	Steel 20' Stainless 12'	1/4, 5/16, 3/8, 1/2, 5/8, 3/4, 7/8, 1, 1 1/8, 1 1/4, 1 1/2, 1 3/4, 2	
	Channel	Steel* 20' Stainless 20' Aluminum 25'	#/ft* 4.1 5.0 7.1 5.4 7.25 6.7 9.0 8.2 10.5 9.8 11.5 13.75 18.75 13.4 15.3 A 3 3 3 4 4 5 5 6 6 7 8 8 8 9 10 B 1.41 1.49 1.94 1.58 1.72 1.75 1.88 1.92 2.03 2.09 2.26 2.34 2.53 2.43 2.60 t .170 .258 .312 .180 .321 .190 .325 .200 .314 .210 .220 .303 .487 .233 .240	
	I-Beam H-Beam	Steel 20-48' Stainless 20'	I-Beam H (Wide)-Beam #/ft 5.7 7.5 7.7 9.5 10 12.5 18.4 13 16 19 15 20 18 24 22 A 3 3 4 4 5 6 8 4.16 5.0 5.15 5.99 6.20 8.14 7.93 10.17 B 2.37 2.51 2.66 2.80 3.0 3.33 4.0 4.08 5.0 5.03 5.99 6.02 5.25 6.50 5.75 t .170 .349 .190 .326 .210 .230 .270 .280 .240 .270 .230 .258 .230 .245 .240	
	Tee Bar	Steel 20' Stainless 20'	1 x 1 x 1/8 1 1/2 x 1 1/2 x 3/16, 1/4 1 1/4 x 1 1/4 x 1/8, 3/16 2 x 2 x 1/4 2 1/2 x 2 1/2 x 1/4	
	Rectangle + SqTube	Steel 20-24' Stainless 20' Aluminum 25'	Many different A x A and A x B choices	
	Buss Bar	Copper 6'	Round or square edge; bar sizes as Flat (above)	

METALS: SHEET PLATE MESH GRATING

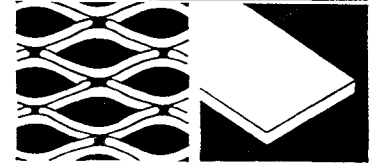

Sheet	Steel & Galv	Ga/Thk"mm	24/.027 .69	22/.033 .85	20/.040 1.0	18/.052 1.3	16/.064 1.6	14/.079 2.0	12/.109 3.5	11/.124 3.5
	Stainless		.024 .61	.030 .76	.036 .91	.048 1.2	.060 1.5	.075 1.9	.105 2.6	.120 3.0
	Brass 260		.020 .51	.025 .64	.032 .81	.040 1.0	.050 1.3	.063 1.6	.080 2.0	.090 2.3
	Copper 110	Oz/Thk"mm	10/.014 .36	12/.016 .41	16/.021 .53	20/.027 .69	24/.032 .81	32/.043 1.1	36/.049 1.2	48/.063 1.6

Typical Sheet Sizes: 48 x 96 48 x 120 some 36 x 96 36 x 120 Brass and Copper: 36 x 96
 Stainless Finishes: 2B/Mill #3/120 Grit Polish #4/180 Grit Polish #8/Mirror
 Custom sizes, Cuts, Bending and Forming

Plate	Steel	Thickness - all	1/8	3/16	1/4	5/16	3/8	1/2	5/8	3/4	7/8	1	and thicker
	Stainless												
	Brass & Brz	Variety of Widths		36"	48"	60"	72"						
	Coppernickl	Variety of Lengths		96"	120"	144"	196"						
	Aluminum	Cut-to-size readily available											



Floor Plate	Steel												
	Stainless												
	Aluminum	Also called diamond plate or safety plate; sizes same as above											

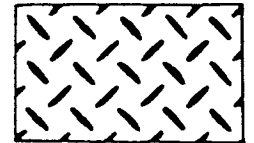

Expanded	Steel	Standard/Raised	Style	Size of diamond opening		Thickness	
	Stainless	or Flattened	Name	Width	Length	Std	Flat
	Aluminum		1/4-20	.125	.718	.135	.030
		see samples	1/2-13	.312	.938	.204	.070
		pg 119	3/4-9(10GA)	.688	1.562	.312	.120
			11/2-9(10GA)	1.125	2.375	.312	—

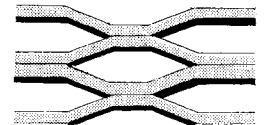

Expanded Grating	Steel	Std/Raised only	3.14lb	1.63	4.88	.688	—
			4.00lb	0.83	3.30	.625	—
		style name =	4.27lb	1.00	2.88	.625	—
		lb/sq. foot	5.00lb	0.76	3.20	.688	—

Grating Bar Type	Steel	Made with 1/8 or 3/16 flat bar on edge at 1 3/16 centers, cross bars at 4" intervals
	Galvanized	To order specify depth: 3/4, 1, 1 1/4, 1 1/2 and edge plain/smooth or serrated grip
	Aluminum	Typically 24" or 36" wide 20' length, other available.

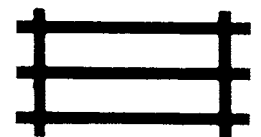

Mesh Wire Cloth	Steel	
	Stainless	
	Brass	To order specify number of mesh strands per inch: samples page 119.

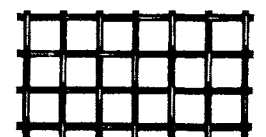

Perforated	Stainless	Common sheets:
	Galvanized	Hole 1/8 dia. offset on 3/16 centers 40% open 16-18-20-22ga 36 x 120 • 14-16ga 48 x 120
	Aluminum	3/16 1/4 5/16 3/8 9/16 1/2 11/16 48% 16-18-20ga 36 x 120 • 16ga 48 x 120 16-18-20ga 36 x 120 16-18-20ga 36 x 120 • 11-14-16ga 48 x 120 16ga 48 x 96 • 16ga 48 x 120 16-18ga 36 x 120

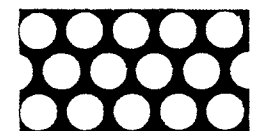

NOTES

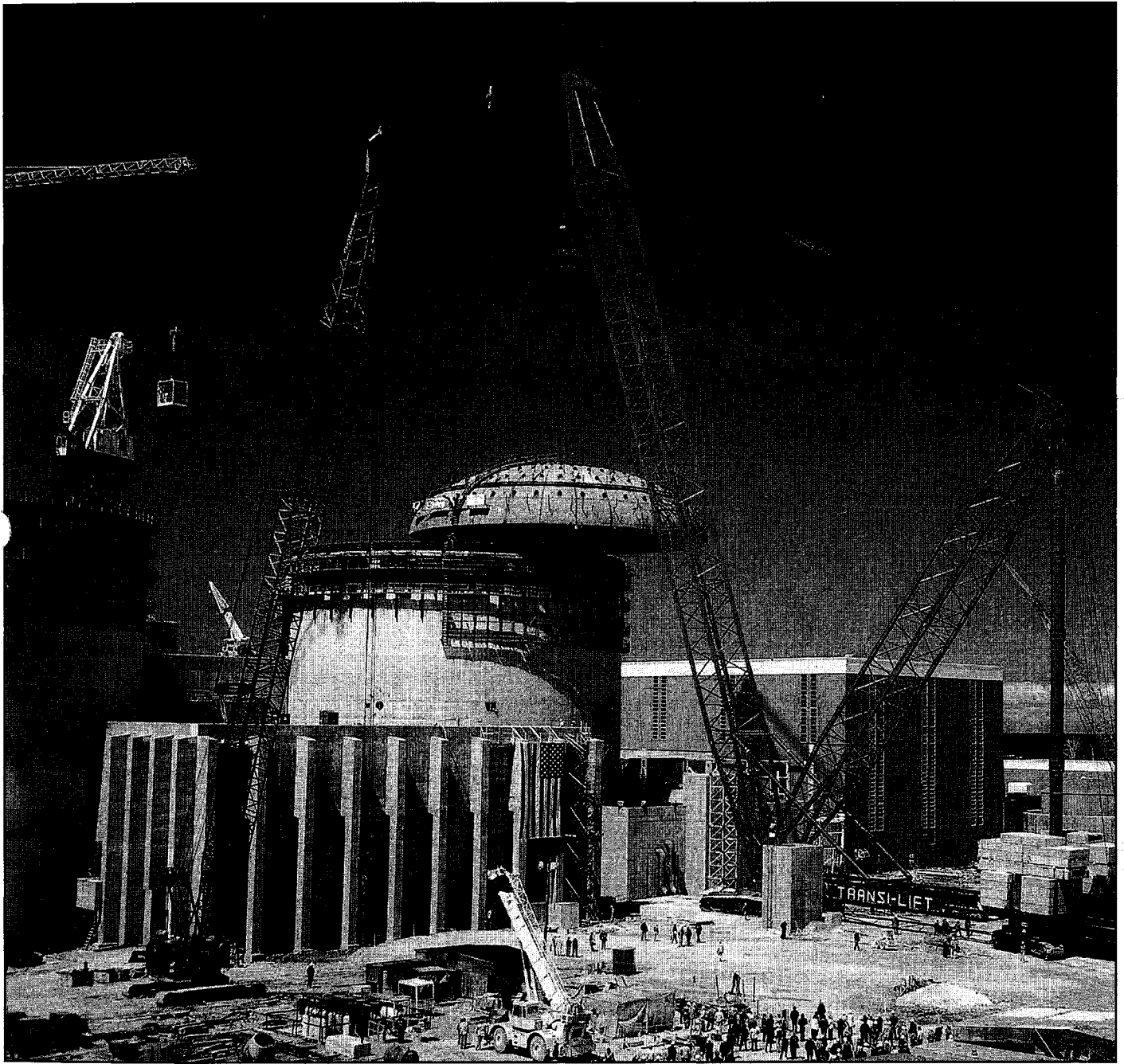

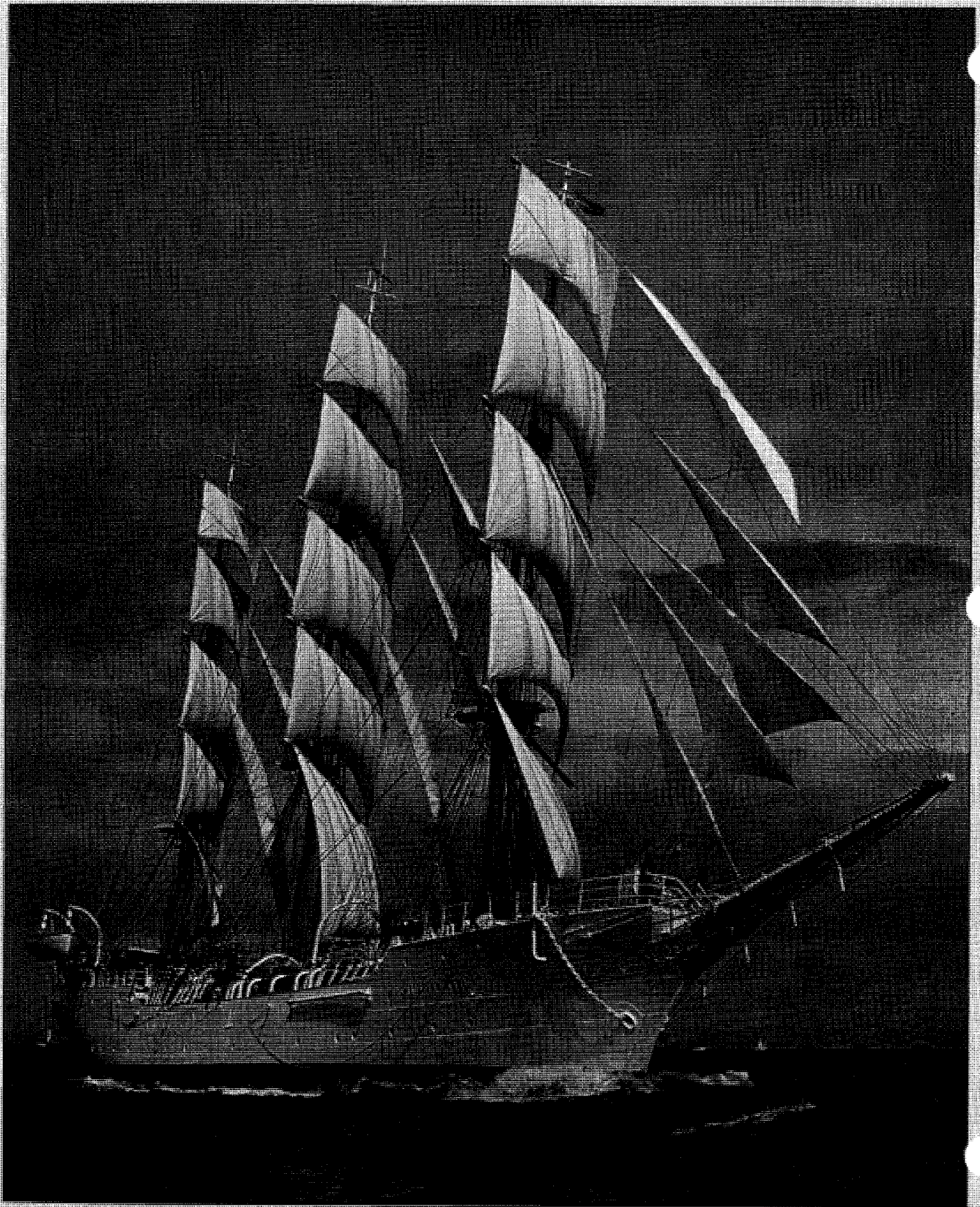

The Christian Radich, Norwegian training vessel, built 1937, Gross tonnage 676, LOA 62.5m (205'), beam 9.8m (32'), draft 4.7m (15.5').

METRIC BRONZE GATE

FLANGED ENDS

DIN or JIS SPECIFICATIONS

SIZES: 15 mm to 250 mm

DIMENSIONS (millimeters)

PN 10/16 DIN (European), THREADED BONNET

SIZE	15	20	25	32	40	50	65	80	100
FF	75	75	80	90	100	110	130	150	160
D	95	105	115	140	150	165	185	200	220
BC	65	75	85	100	110	125	145	160	180
wt(kg)	2	2	3	4	4	5	9	12	19

PN 10/16 DIN (European), BOLTED BONNET

SIZE	40	50	65	80	100	125	150	200	250 (10K)
FF	140	150	170	180	190	200	210	230	250
D	150	165	185	200	220	250	285	340	395
BC	110	125	145	160	180	210	240	295	350
wt(kg)	10	10	15	22	28	37	49	74	105

5K JIS (Japanese) F-7367, UNION BONNET

SIZE	15	20	25	32	40
FF	90	100	110	130	140
D	80	85	95	115	120
BC	60	65	75	90	95
wt(kg)	2	3	4	6	8

10K JIS (Japanese) F-7368, UNION BONNET

SIZE	15	20	25	32	40
FF	100	110	120	140	150
D	95	100	125	135	140
BC	70	75	90	100	105
wt(kg)	3	4	6	8	10

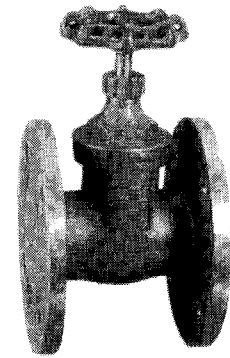
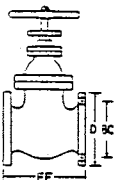

DIN PN 10/16
Threaded Bonnet
993102

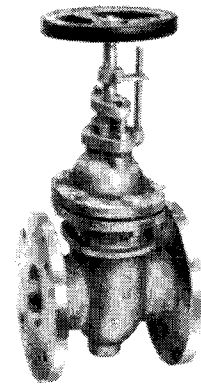

DIN PN 10/16
Bolted Bonnet
993102

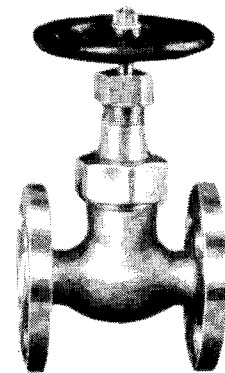

JIS 5K 941103
10K 942103

METRIC BRONZE GLOBE & ANGLE

FLANGED ENDS

DIN or JIS SPECIFICATIONS

SIZES: 15 mm to 300 mm

DIMENSIONS (millimeters)

PN 16 DIN (European), UNION BONNET

SIZE	15	20	25	32	40	50	65	80	100
FF	70	80	90	105	120	140	180	200	230
CF	65	70	75	90	100	105	115	125	
D	95	105	115	140	150	165	185	200	220
BC	65	75	85	100	110	125	145	160	180
wt(kg)	2	3	4	6	7	10	12	16	21

PN 10/16 DIN (European), BOLTED BONNET

SIZE	50	65	80	100	125	150	200	250	300
FF	180	200	240	270	320	370	500	730	850
CF	105	115	125	145	170	200	250	325	375
D	165	185	200	220	250	285	340	395	445
BC	125	145	160	180	210	240	295	350	400
wt(kg)	13	23	32	43	65	89	136	217	323

5K JIS (Japanese) GLOBE F-7301, ANGLE F-7302
SCREW DOWN CHECK GLOBE F-7351, SCREW DOWN CHECK ANGLE F-7352

SIZE	15	20	25	32	40	50	65	80	100	125
FF	100	110	120	140	160	210	250	280	340	410
CF	55	60	65	80	85	100	115	130	150	170
D	80	85	95	115	120	130	155	180	200	235
BC	60	65	75	90	95	105	130	145	165	200
wt(kg)	2	3	4	5	6.5	12	17	25	38	52

16K JIS (Japanese) GLOBE F-7303, ANGLE F-7304
SCREW DOWN CHECK GLOBE F-7409, SCREW DOWN CHECK ANGLE F-7410

SIZE	15	20	25	32	40
FF	110	120	130	160	180
CF	70	75	85	95	100
D	95	100	125	135	140
BC	70	75	90	100	105
wt(kg)	3	4	5	7	9

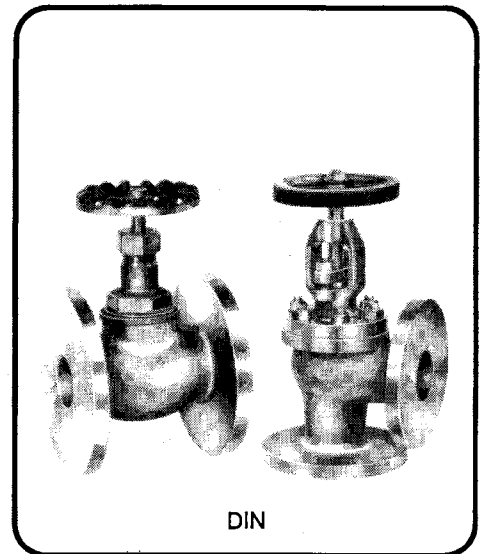
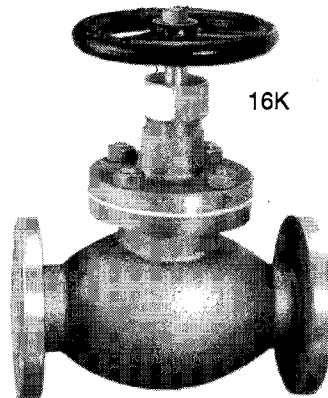

PN 16 Globe U.B. 993302
PN 16 Angle U.B. 993402
PN 10/16 Globe B.B. 993303
PN 10/16 Angle B.B. 993403

* Add "SDNR" suffix for screw down, non return stop check

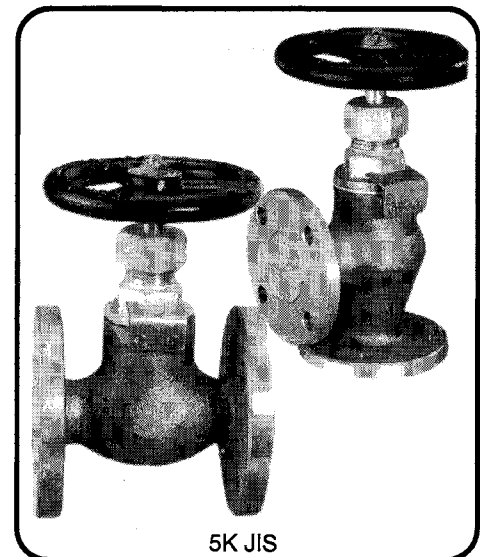
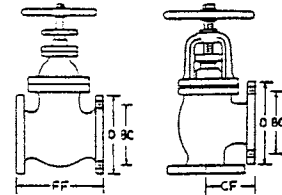

5K Globe 941303
5K Angle 941403
16K Globe 943303
16K Angle 943403

* Add "SDC" suffix for screw down check stop check

W & O SUPPLY INC

METRIC HOSE VALVES

SIZES: 15mm to 65mm

Bronze Construction
JIS and DIN style
Straight and Angle

JIS STYLE

Size	KG	Flg Diam	PCD	Holes	Hose Thread	End Type
15	5	80	60	4	M42 x 2	Hose Thread Cap
	10	95	70	4	M42 x 2	Hose Thread Cap
25	5	95	75	4	M42 x 2	Hose Thread Cap
	10	125	90	4	M42 x 2	Hose Thread Cap
40	5	120	95	4	M52 x 2	Nakajima Coupling
	10	140	105	4	M52 x 2	Nakajima Coupling
50	5	130	105	4	M64 x 2	Nakajima Coupling
	10	155	120	4	M64 x 2	Nakajima Coupling
65	10	175	140	4	M80 x 2	Nakajima Coupling

DIN STYLE

Size	Flg Diam	PCD	Holes	End Type
40	150	110	4	Storz Coupling
50	165	125	4	Storz Coupling
65	185	145	4	Storz Coupling

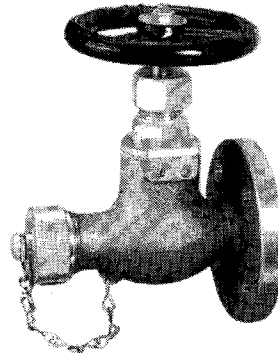

Hose Globe
5K - 941333
10K - 942333

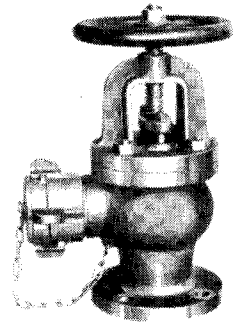

Hose Angle
5K - 941433
10K - 942433

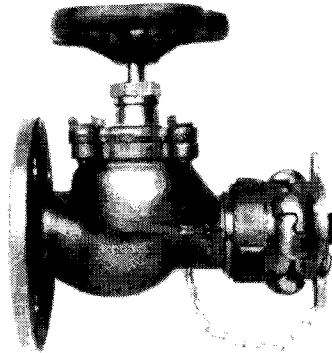

Hose Globe
PN 10/16 - 993333

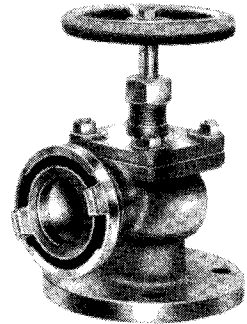

Hose Angle
PN 10/16 - 993433

HOSE FITTINGS

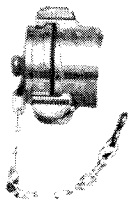

Nakajima
Cap



JIS Metric
Thread Cap

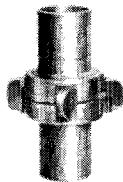

Nakajima
Coupling "F"

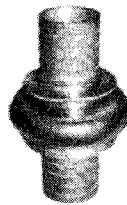

JIS B
Coupling



Storz
Coupling



Female or Male
Thread Storz
Adapter

METRIC BRONZE CHECKS

FLANGED ENDS OR WAFER TYPE

DIN or JIS SPECIFICATIONS

SIZES: 15mm to 250mm

5K JIS (Japanese) SWING CHECK F-7371

SIZE	25	32	40
FF	110	130	140
D	95	115	120
BC	75	90	95
wt(kg)	2	3	4

5K JIS (Japanese) LIFT CK F-7356, F-7415; ANGLE CK F-7416

SIZE	15	20	25	32	40
FF	55	60	120	140	160
D	100	110	95	115	120
BC	60	65	75	90	95
wt(kg)	2	2	3	4	5

PN 10/16 DIN (European) LIFT CHECK

SIZE	15	20	25	32	40	50	65	80	100
FF	70	80	90	105	120	140	180	200	230
D	95	105	115	140	150	165	185	200	220
BC	65	75	85	100	110	125	145	160	180
wt(kg)	2	2	2	4	5	7	10	13	19

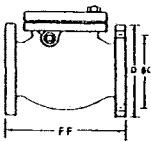

PN 10/16 DIN (European) WAFER CHECK

This thin wafer valve is designed to fit between two joining flanges. The outside diameter of the valve is dimensioned to fit inside the bolts of the joining flanges.

SIZE	40	50	65	80	100	125	150	200	250
Thickness	16	16	16	16	16	18	19	29	29
Diameter	94	109	129	144	164	195	221	276	330
Bore	19	30	38	48	73	96	116	143	190

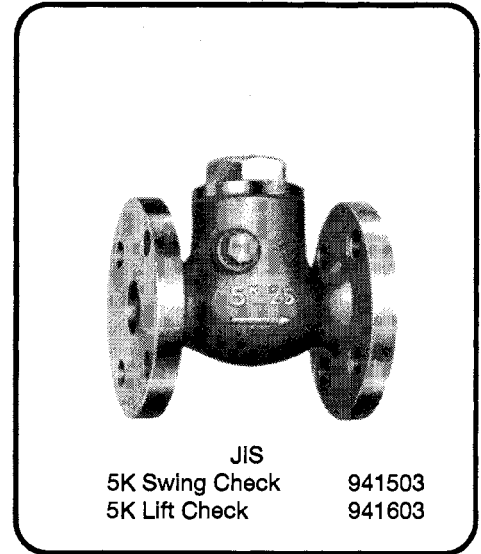

JIS
5K Swing Check 941503
5K Lift Check 941603

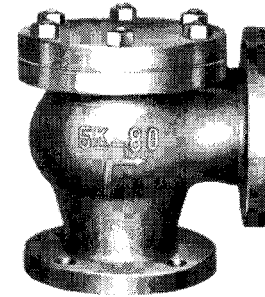

Angle Check
941803

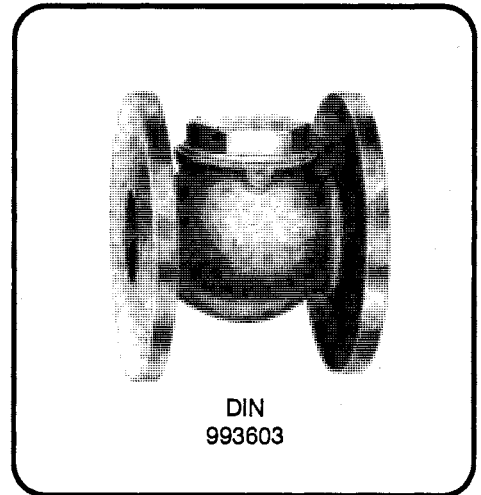

DIN
993603

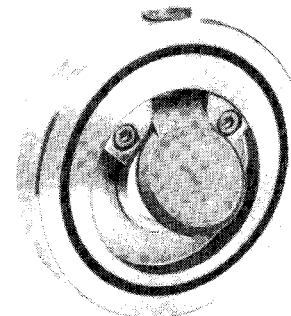

Wafer Check
993903

METRIC CAST IRON CHECK VALVES

FLANGED ENDS

DIN or JIS SPECIFICATIONS

SIZES: 40mm to 500mm

Cast Iron body with bronze trim
Ductile (Nodular) Iron body add "DI" to figure number

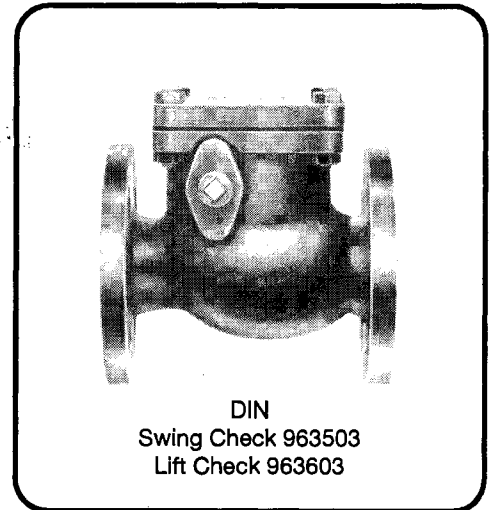

PN 10/16 DIN (European) SWING CHECK

SIZE	40	50	65	80	100	125	150	200	250	300
FF	180	200	230	260	300	350	400	500	600	700
D	150	165	185	200	220	250	285	340	395	445
BC	110	125	145	160	180	210	240	295	350	400
wt(kg)	10	12	17	22	28	42	54	86	160	210

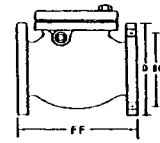

PN 10/16 DIN (European) LIFT CHECK

SIZE	15	20	25	32	40	50	65	80	100	125	150	200
FF	130	150	160	180	200	230	290	310	350	400	480	600
D	95	105	115	140	150	165	180	200	220	250	285	340
BC	65	75	85	100	110	125	145	165	180	210	240	295
wt(kg)	2	3	4	6	7	10	15	20	31	49	69	132

5K JIS (Japanese) SWING CHECK F-7372

SIZE	50	65	80	100	125	150	200	250
FF	190	220	250	280	330	380	460	550
D	130	155	180	200	235	265	320	385
BC	105	130	145	165	200	230	280	345
wt(kg)	9	14	19	27	39	54	94	150

10K JIS (Japanese) SWING CHECK F-7373

SIZE	50	65	80	100	125	150	200
FF	21	240	270	300	350	400	480
D	155	175	185	210	250	280	330
BC	120	140	150	175	210	240	290
wt(kg)	14	20	23	31	49	65	103

5K JIS (Japanese) LIFT CHECK F-7358

SIZE	50	65	80	100	125	150
FF	210	250	280	340	410	480
D	130	155	180	200	235	265
BC	105	130	145	165	200	230
wt(kg)	11	17	23	33	48	68

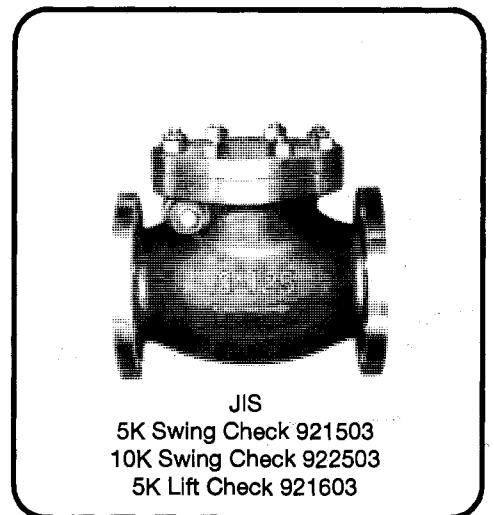

METRIC CAST IRON GATE

FLANGED ENDS

DIN or JIS SPECIFICATIONS

SIZES: 40 mm to 500 mm

Cast Iron body with bronze trim
Ductile (Nodular) Iron body add "DI" to figure number

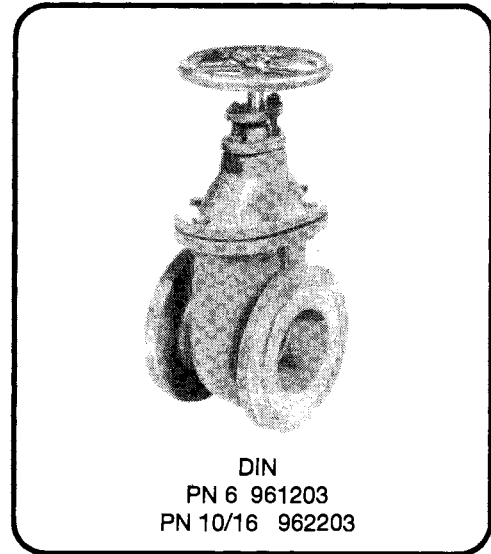

DIN
PN 6 961203
PN 10/16 962203

DIMENSIONS (millimeters) PN 6 DIN (European)

SIZE	40	50	65	80	100	125	150	200	250	300	350	400	450	500
FF	140	150	170	180	190	200	210	230	250	270	290	310	330	350
D	130	140	160	190	210	240	265	320	375	440	490	540	595	645
BC	100	110	130	150	170	200	225	280	335	395	445	495	550	600
wt(kg)	9	10	14	19	25	40	59	97	138	163	230	295	385	520

PN 10/16 DIN (European)

SIZE	40	50	65	80	100	125	150	175	200	250	300	350	400	450	500
FF	140	150	170	180	190	200	210	220	230	250	270	290	310	330	350
D 10/16	150	165	185	200	220	250	285	315	340	395/405	445/460	505/520	565/580	615/640	670/715
BC10/16	110	125	145	160	180	210	240	270	295	350/355	400/410	460/470	515/525	565/585	620/650
wt(kg)	9	10	14	19	25	40	59	80	97	138	163	230	295	385	520

5K JIS (Japanese) F-7363

SIZE	50	65	80	100	125	150	200	250	300	350	400	450	500
FF	180	190	200	230	250	270	290	330	370	410	470	500	550
D	130	155	180	200	235	265	320	385	430	480	540	605	655
BC	105	130	145	165	200	230	280	345	390	435	495	555	605
wt(kg)	14	19	24	35	48	65	103	164	236	307	405	581	725

10K JIS (Japanese) F-7364

SIZE	50	65	80	100	125	150	200	250	300	350	400	450	500
FF	200	220	230	250	270	290	320	380	440	500	590	640	710
D	155	175	185	210	250	280	330	400	445	490	560	620	675
BC	120	140	150	175	210	240	290	355	400	445	510	565	620
wt(kg)	19	28	33	46	66	86	136	230	331	433	597	704	901

16K JIS (Japanese) F-7369

SIZE	50	65	80	100	125	150	200	250	300	350	400
FF	210	240	260	290	310	330	370	430	490	540	610
D	155	175	200	225	270	305	350	430	480	540	605
BC	120	140	160	185	225	260	305	380	430	480	540
wt(kg)	20	28	36	50	71	93	150	249	403	573	782

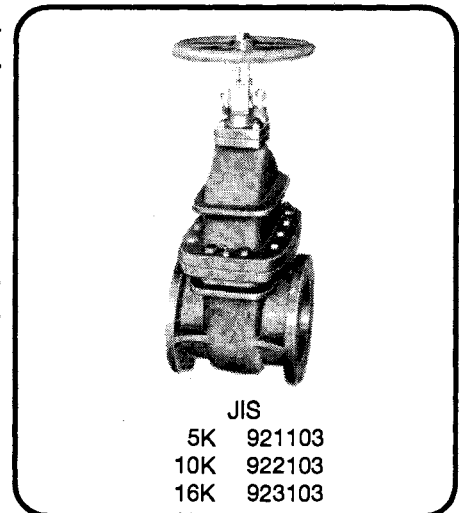
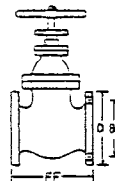

JIS
5K 921103
10K 922103
16K 923103

METRIC CAST IRON GLOBE & ANGLE

FLANGED ENDS

DIN or JIS SPECIFICATIONS

SIZES: 15 mm to 550 mm

Cast Iron Body or Nodular (Ductile) Iron
Bronze Trim

PN 6 DIN (European) GLOBE, ANGLE & NON RETURN

SIZE	15	20	25	32	40	50	65	80	100	125	150	200	250	300
FF	130	150	160	180	200	230	290	310	350	400	480	600	730	850
CF	90	95	100	105	115	125	145	155	175	200	225	275	325	375
D	80	90	100	120	130	140	160	190	210	240	265	320	375	440
BC	55	65	75	90	100	110	130	150	170	200	225	280	335	395
wt(kg)	4	4	6	8	10	13	21	26	41	60	83	136	217	325

PN 10/16 DIN (European) GLOBE, ANGLE & NON RETURN

SIZE	15	20	25	32	40	50	65	80	100	125	150	200	250	300
FF	130	150	160	180	200	230	290	310	350	400	480	550	600	730
CF	90	95	100	105	115	125	145	155	175	200	225	250	275	325
D 10/16	95	105	115	140	150	165	185	200	220	250	285	340	395/405	445/460
BC10/16	65	75	85	100	110	125	145	160	180	210	240	295	350/355	400/410
wt(kg)	4	5	6	8	11	13	21	26	41	60	83	136	217	325

5K JIS (Japanese) GLOBE F-7305, ANGLE F-7306, SCREW DOWN CHECK GLOBE F-7353, SCREW DOWN CHECK ANGLE F-7354

SIZE	50	65	80	100	125	150	200	250	300
FF Globe	210	250	280	340	410	480	570	740	840
CF Angle	100	115	130	150	170	190	220	275	310
D	130	155	180	200	235	265	320	385	430
BC	105	130	145	165	200	230	280	345	390
wt(kg)	15	21	28	41	58	80	139	216	346

10K JIS (Japanese) GLOBE F-7307, ANGLE F-7308, SCREW DOWN CHECK GLOBE F-7375, SCREW DOWN CHECK ANGLE F-7376

SIZE	50	65	80	100	125	150	200	250	300
FF	220	270	300	350	420	490	570	740	840
CF	120	130	140	160	180	205	230	290	320
D	155	175	185	210	250	280	330	400	445
BC	120	140	150	175	210	240	290	355	400
wt(kg)	20	29	32	49	73	104	462	304	458

16K JIS (Japanese) GLOBE F-7309, ANGLE F-7310 SCREW DOWN CHECK GLOBE F-7377, SCREW DOWN CHECK ANGLE F-7378

SIZE	50	65	80	100	125	150	200	250	300
FF	220	270	300	350	430	500	570	760	860
CF	120	130	150	170	200	225	250	310	340
D	155	175	200	225	270	305	350	430	480
BC	120	140	160	185	225	260	305	380	430
wt(kg)	18	25	35	49	76	103	155	257	380

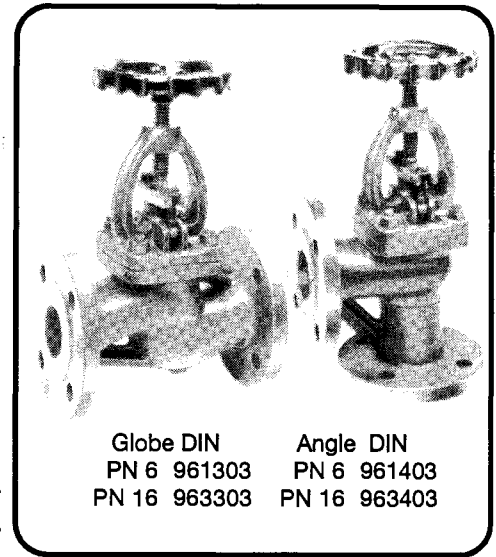

Globe DIN PN 6 961303
Angle DIN PN 6 961403
PN 16 963303 PN 16 963403

Globe Ductile Iron 973303
Angle Ductile Iron 973403

Add "SDNR" Suffix for Screw Down Non-Return Stop Check

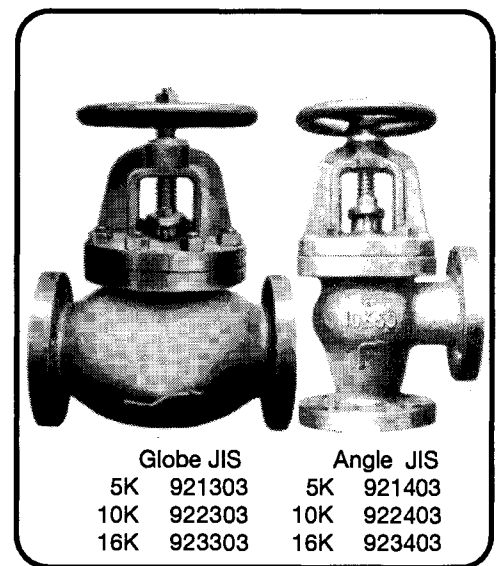
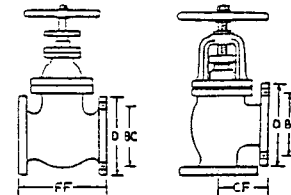

Globe JIS 5K 921303
Angle JIS 5K 921403
10K 922303 10K 922403
16K 923303 16K 923403

Add "SDC" Suffix for Screw Down Check Stop Check

METRIC CAST STEEL GATE

FLANGED ENDS

DIN or JIS SPECIFICATIONS

SIZES: 40 mm to 500 mm

Cast Steel Body
Available With Bronze or Stainless Trim
Non-Rising or Rising Stem

DIMENSIONS (millimeters)

PN 10 DIN (European)

SIZE	40	50	65	80	100	125	150	200	250	300	350	400
FF	140	150	170	180	190	200	210	230	250	270	290	310
D	150	165	185	200	220	250	285	340	395	445	505	565
BC	110	125	145	160	180	210	240	295	350	400	460	515
wt(kg)	13	16	19	24	31	40	49	73	111	140	190	240

PN 16 DIN (European) Long Pattern

SIZE	40	50	65	80	100	125	150	200	250	300	350	400
FF	240	250	270	280	300	325	350	400	450	500	550	600
D	150	165	185	200	220	250	285	340	405	460	520	580
BC	110	125	145	160	180	210	240	295	355	410	470	525
wt(kg)	24	25	35	38	49	57	86	146	230	314	438	590

10K JIS (Japanese) F-7366

SIZE	50	65	80	100	125	150	200	250	300	350	400
FF	200	220	230	250	270	290	310	340	380	420	480
D	155	175	185	210	250	280	330	400	445	490	560
BC	120	140	150	175	210	240	290	355	400	445	510
wt(kg)	17	27	32	45	63	82	130	203	291	368	507

16K JIS (Japanese)

SIZE	50	65	80	100	125	150	200	250	300	350	400
FF	210	240	260	290	310	330	370	430	490	540	610
D	155	175	200	225	270	305	350	430	480	540	605
BC	120	140	160	185	225	260	305	380	430	480	540
wt(kg)	20	28	36	50	71	93	150	249	403	573	732

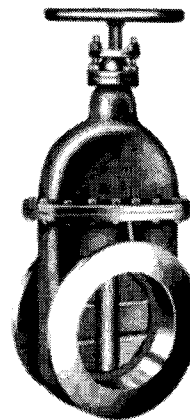

DIN PN 10 952203
PN 16 953201

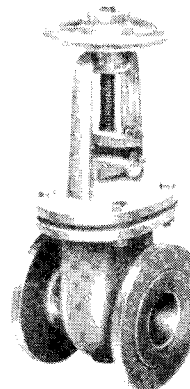

OSY
DIN PN 10 952101

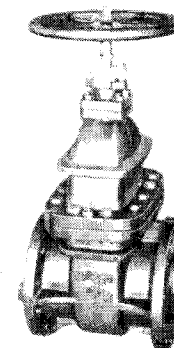

JIS 10K 912103
16K 913103

METRIC CAST STEEL GLOBE & ANGLE

FLANGED ENDS

SIZES: 15 mm to 300 mm

Cast Steel Body

Available with Bronze or Stainless Trim

DIMENSIONS (millimeters)

PN 16 DIN (European)

SIZE	15	20	25	32	40	50	65	80	100	125	150	200	250	300
FF	130	150	160	180	200	230	290	310	350	400	480	600	730	850
CF	90	95	100	105	115	125	145	155	175	200	225	275	325	375
D	95	105	115	140	150	165	185	200	220	250	285	340	405	460
BC	65	75	85	100	110	125	145	160	180	210	240	295	355	410
wt(kg)	5	6	7	11	14	19	30	34	49	69	98	180	280	360

PN 40 DIN (European)

SIZE	15	20	25	32	40	50	65	80	100	125	150	200	250	300
FF	130	150	160	180	200	230	290	310	350	400	480	600	730	850
CF	90	95	100	105	115	125	145	155	175	200	225	275	325	375
D	95	105	115	140	150	165	185	200	235	270	300	375	450	515
BC	65	75	85	100	110	125	145	160	190	220	250	320	385	450
wt(kg)	5	6	7	11	14	19	30	34	49	69	98	180	280	360

5K JIS (Japanese) GLOBE F-7311, ANGLE F-7312

SIZE	50	65	80	100	125	150	200	250	300
FF	210	250	280	340	410	480	570	740	840
CF	100	115	130	150	170	190	220	275	310
D	130	155	180	200	235	265	320	385	430
BC	105	130	145	165	200	230	280	345	390
wt(kg)	15	21	28	41	58	80	139	230	309

10K JIS (Japanese) GLOBE F-7319, ANGLE F-7320

SIZE	50	65	80	100	125	150	200	250	300
FF	220	270	300	350	420	490	570	740	840
CF	120	130	140	160	180	205	230	290	320
D	155	175	185	210	250	280	330	400	445
BC	120	140	150	175	210	240	290	335	400
wt(kg)	18	26	30	45	70	96	159	257	370

20K JIS (Japanese) GLOBE F-7421 & F-7313, ANGLE F-7422 & F-7314 SCREW DOWN CHECK GLOBE F-7473, SCREW DOWN CHECK ANGLE F-7474

SIZE	15	20	25	32	40	50	65	80	100	125	150	200
FF	140	160	180	190	200	230	270	300	350	430	500	560
CF	75	80	95	100	110	125	135	150	170	200	225	280
D	95	100	125	135	140	155	175	200	225	270	305	350
BC	70	75	90	100	105	120	140	160	185	225	260	305
wt(kg)	4	5	8	14	16	22	30	44	62	95	132	204

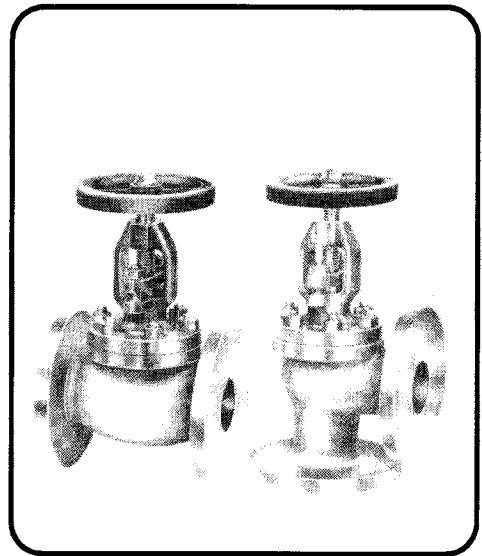

DIN PN 16 Globe 953300
 Angle 953400
DIN PN 40 Globe 953301
 Angle 953401

Add "SNDR" suffix for screw down
non return stop check

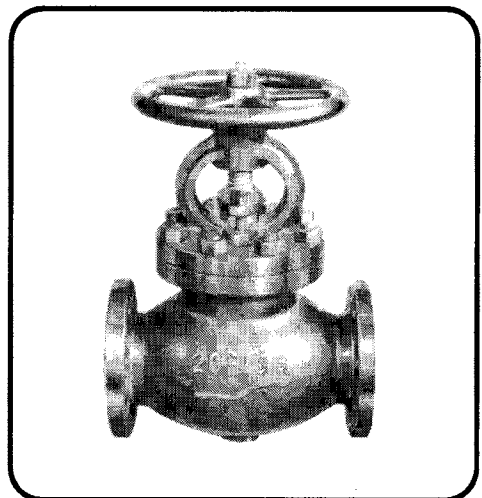
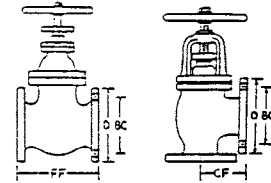

JIS 5K Globe 911303
 Angle 911403
 Check 911503
JIS 10K Globe 912303
 Angle 912403
JIS 20K Globe 914301
 Angle 914401

Add "SDC" suffix for screw down check

METRIC VALVES

FORGED STEEL

SIZES: 15mm to 40mm

Flanged ends
Forged steel body
Stainless trim

Also available with thread or socket ends

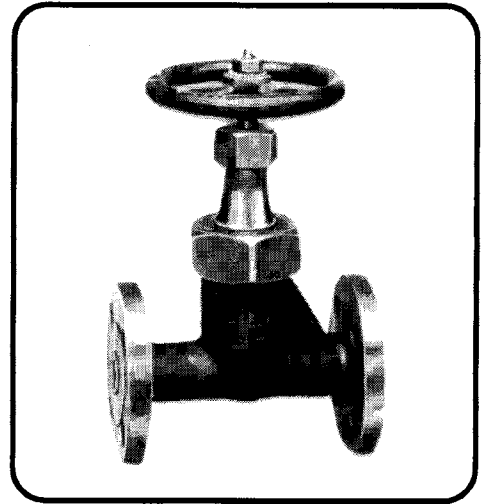

20K JIS Globe F-7421, Angle F-7422

Size	15	20	25	32	40
FF	140	160	180	See cast	
CF	75	80	95	steel	
D	95	100	125	pg 131	
BC	70	75	90		
wt (kg)	4	5	7		

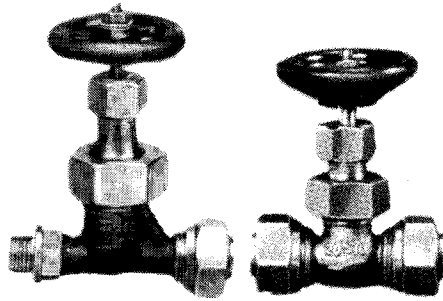

Male Thread by
Union Socket
6 & 10 mm

Double Union
Socketweld
6 & 10 mm

Globe
20K 914301
40K 916301
15 to 25 mm

Angle
20K 914401
40K 916401
15 to 25 mm

40K JIS Globe F-7329, Angle F-7330

Size	15	20	25
FF	150	170	200
CF	90	95	100
D	115	120	130
BC	80	85	95
wt (kg)	6	7	10

METRIC VALVES

MALLEABLE IRON

SIZES: 15mm to 40mm

Flanged ends
Bronze or SS trim

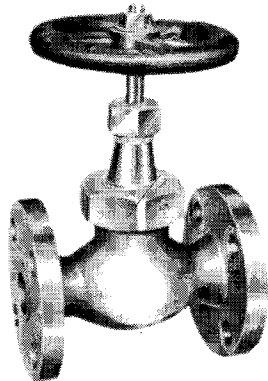

Globe
5K 921303
16K 923303

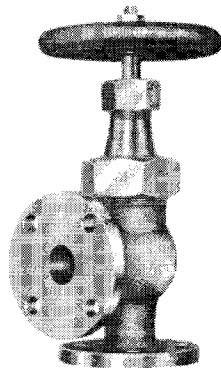

Angle
5K 921403
16K 923403

5K JIS Globe F-7321, Angle F-7322

Size	15	20	25	32	40
FF	100	110	120	140	160
CF	55	60	65	80	85
D	80	85	95	115	120
BC	60	65	75	90	95
wt (kg)	2	3	4	5	6.5

16K JIS Globe F-7323, Angle F-7324

Size	15	20	25	32	40
FF	110	120	130	160	180
CF	70	75	85	95	100
D	95	100	125	135	140
BC	70	75	90	100	105
wt (kg)	3	4	5	7	9

METRIC VALVES

BRONZE

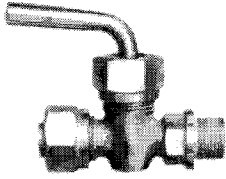

JIS 16K Cock
F-7387
Sizes 6, 10, 15, 20 mm
944803

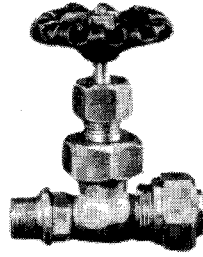

JIS 20K Globe
F-7388
Sizes 6 mm & 10 mm
944303

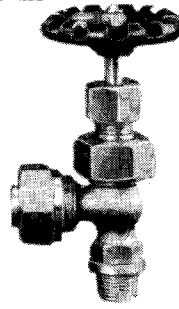

JIS 20K Angle
F-7389
Sizes 6 mm & 10 mm
944403

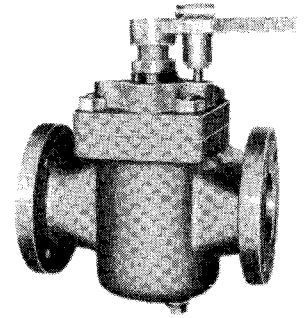

JIS 5K Cock
F-7380
Size 25 mm to 65 mm
944804

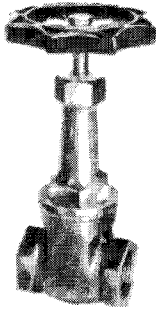

JIS Thread Gate
5K JIS-B-2013
940105
10K JIS-B-2023
940110



JIS Thread Globe
5K JIS-B-2011
940305
10K JIS-B-2021
940310

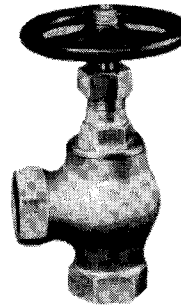

JIS Thread Angle
5K JIS-B-2012
940405
10K JIS-B-2022
940410

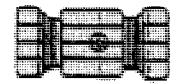

Ball-O-Fix
944944

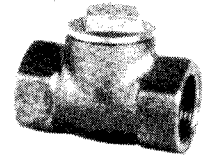

JIS Thread Check
5K JIS-B-2015
940505
10K JIS-B-2025
940510

MISCELLANEOUS

Other pipeline products to metric standards: such as strainers, steam traps and ball valves available.

Emergency shut-off valves are designed to operate manually by trip wire or automatically by use of pneumatic, hydraulic or heat fusible link. Supplied with trip wire lever unless otherwise specified. Sizes: 15mm to 150mm.

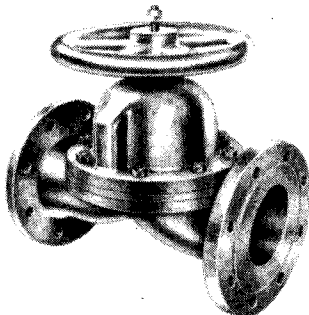

Diaphragm Valves
Weir
Straight Through/KB

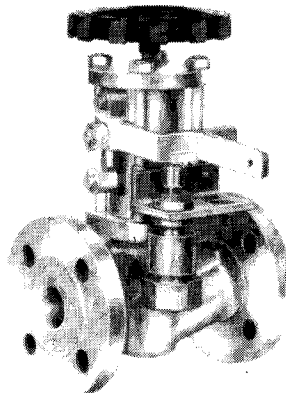

Emergency Shut-Off Globe
DIN PN16 Iron 982303
DIN PN40 Steel 981301
JIS F-7399 Steel 931301

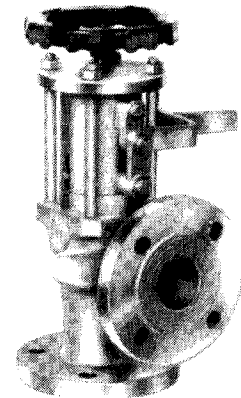

Emergency Shut-Off Angle
DIN PN16 Iron 982403
DIN PN40 Steel 981401
JIS F-7399 Steel 931401

METRIC CAST STEEL CHECK VALVES

FLANGED ENDS

DIN or JIS SPECIFICATIONS

SIZES: 40mm to 500mm

PN 16 DIN (European) SWING CHECK

SIZE	40	50	65	80	100	125	150	200	250
FF	180	200	240	260	300	350	400	500	600
D	150	165	185	200	250	220	285	340	405
BC	110	125	145	160	180	210	240	295	355
wt(kg)	12	16	22	29	41	57	75	120	195

PN 40 DIN (European) LIFT CHECK

SIZE	15	20	25	32	40	50	65	80	100	125	150	200	250	300
FF	130	150	160	180	200	230	290	310	350	400	480	500	730	850
D	95	105	115	140	150	165	185	200	235	270	300	375	450	515
BC	65	75	85	100	110	125	145	160	190	220	250	320	385	450
wt(kg)	4	4	5	8	11	15	25	26	42	56	82	152	230	290

10K JIS (Japanese) SWING CHECK

SIZE	50	65	80	100	125	150	200
FF	210	240	270	300	350	400	480
D	155	175	185	210	250	280	330
BC	120	140	150	175	210	240	290
wt(kg)	14	20	23	31	49	65	103

10K JIS (Japanese) LIFT CHECK

SIZE	50	65	80	100	125	150	200
FF	220	270	300	350	420	490	570
D	155	175	185	210	250	280	330
BC	120	140	150	175	210	240	290
wt(kg)	15	25	30	40	60	80	120

PN 10/16 DIN (European) WAFER SWING CHECK

SIZE	50	65	80	100	125	150	200	250
Thickness	19	19	19	19	19	19	29	29
Diameter	109	129	144	164	195	221	276	330
Bore	26	38	47	70	92	114	143	190

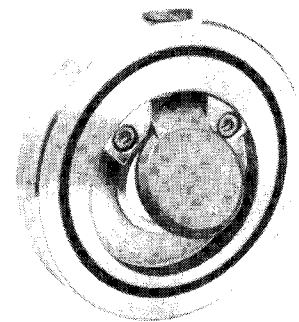
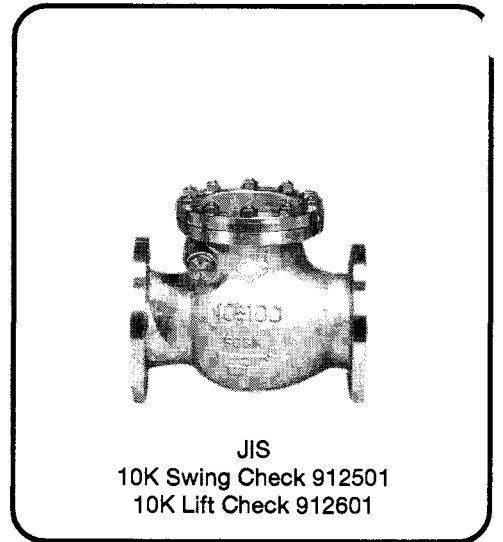
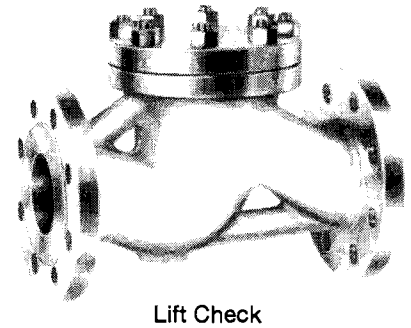
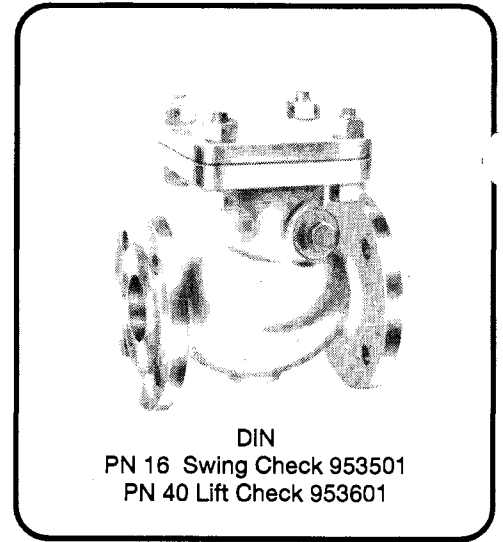
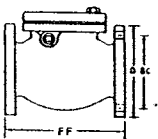

Steel - 953901
Stainless - 983901

W & O SUPPLY INC

METRIC BUTTERFLY VALVES

SIZES: 40mm to 750mm
JIS and DIN

Wafer, Lug, Flanged styles in Iron, Ductile (Nodular) Iron Body, Rubber Seat. Refer to numbers and options below. Standard valve is wafer iron body, buna liner, lever.

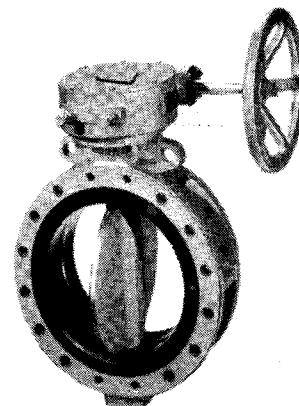
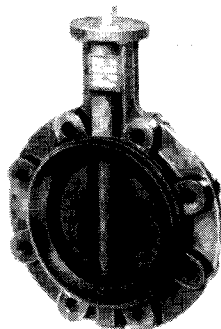
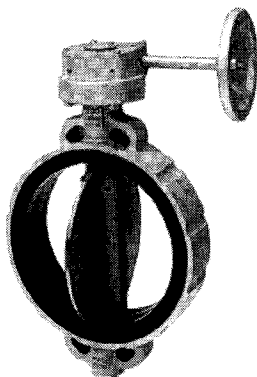
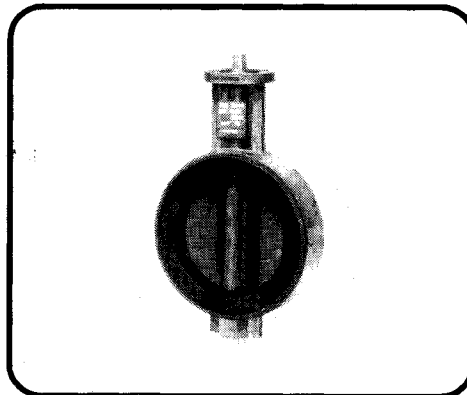

		Wafer	Lug	Flanged
5K JIS	Brz Disc	949102-5	949202-5	949302-5
	SS Disc	949107-5	949207-5	949307-5
JIS	Brz Disc	949102-10	949202-10	949302-10
	SS Disc	949107-10	949207-10	949307-10
PN 6 DIN	Brz Disc	949402-6	949502-6	949602-6
	SS Disc	949407-6	949507-6	949607-6
PN 10 DIN	Brz Disc	949402-10	949502-10	949602-10
	SS Disc	949407-10	949507-10	949607-10
PN 16 DIN	Brz Disc	949402-16	949502-16	949602-16
	SS Disc	949407-16	949507-16	949607-16

Options available: Ductile (Nodular) Iron body: add DI to item number
 Monel Disc add MD to item number
 Gear Operator add GO to item number
 Viton Seat/Liner add VS to item number
 EPDM Seat/Liner add EP to item number

TOMOE®

SIZES: 40mm to 750mm

Wafer, Lug (shown above), Flanged styles in Iron, Ductile (Nodular) Iron, Steel, Aluminum body, Rubber Seat. Numbers and options below. Standard valve is wafer iron body, buna liner, lever operator.

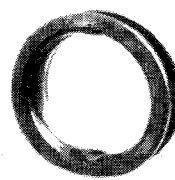

Replacement Seats

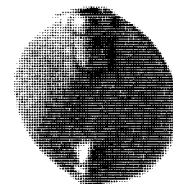

Replacement Discs

		700 S Wafer Cast Iron	700 Z Wafer Aluminum	720 F Flanged Cast Steel
5K	Brz Disc	949702-5	949708-5	949722-5
	SS Disc	949707-5	949709-5	949727-5
JK	Brz Disc	949702-10	949708-10	949722-10
	SS Disc	949707-10	949709-10	949727-10

Options available: Ductile (Nodular) Iron body: add DI to item number
 Lug Style (shown above) add LG to item number
 Gear Operator add GO to item number
 EPDM Seat/Liner add EP to item number



Lever Opt.

METRIC STORM SCUPPER VALVES

SIZES: 40m to 150mm

DIN or JIS Specifications

Bronze or Steel Construction
Horizontal, Vertical or Angle type
With or without manual closing gag control
Flanged ends, drilled or blank no holes

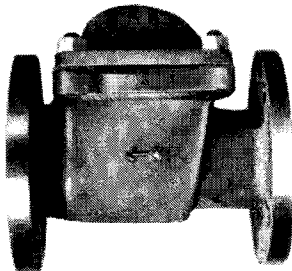

DIN Style:

Horizontal
Steel - 998101
Bronze - 998201

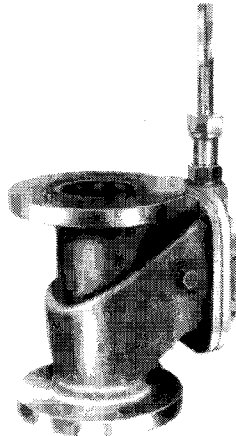

Vertical (shown with control)
Steel - 998102
Bronze - 998202

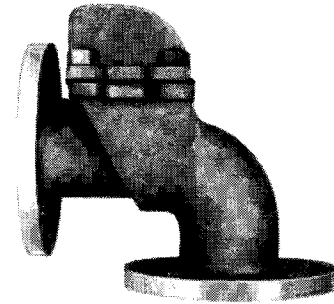

Angle
Steel - 998103
Bronze - 998203

JIS Style:

Steel - 948101
Bronze - 948201

Steel - 948102
Bronze - 948202
5K Bronze - 949901

Steel - 948103
Bronze - 948203

METRIC FITTINGS MISCELLANEOUS

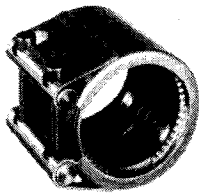

NormaConnect®
Pipe Coupling
540101 (page 118)

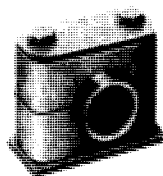

Staff
Tube Support
185000 (page 103)

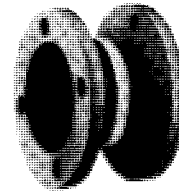

Expansion
Joints
(page 115)

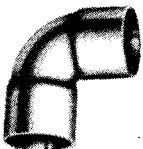

Wrot Copper
Sweat/Soldering
page 102



PVC/CPVC
Thd/Socket
page 99



Iron
BSP Threaded
page 90



Nipples
Hex Type
page 95

METRIC TUBING

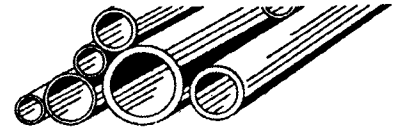

Fittings listed on page 102, 139

STEEL HYDRAULIC TUBING DIN 2391 CLASS C 6 Meter Lengths - Fig 871000 Specify OD + Wall

OD mm	4	6	8	10	12	14	15	16	18	20	22	25	28	30	35	38	42
Light Wall KG/CM ²	0.5 242	1.0 322	1.0 242	1.0 193	1.5 242	2.0 276	1.5 193	2.0 242	1.5 161	2.0 193	1.5 132	2.5 193	2.0 138	2.5 161	3.0 166	3.0 153	3.0 132
Med. Wall KG/CM ²	.75 363	1.5 483	1.5 363	1.5 280	2.0 322	2.5 345	2.0 258	2.5 302	2.0 215	2.5 242	2.0 176	3.0 232	3.0 207	3.0 193	4.0 221	4.0 204	4.0 185
Hvy. Wall KG/CM ²	1.0 483	2.0 644	2.0 483	2.0 387	2.5 403	3.0 414	2.5 322	3.0 363	2.5 269	3.0 290	2.5 220	4.0 309	4.0 276	4.0 258	5.0 276	5.0 234	5.0 230

KG/CM² = operating pressure, based on 4 to 1 safety factor

STAINLESS TUBING DIN 2343 5-6 Meter Lengths - Fig 877000

OD mm	6	8	10	12	14	15	16	18	20	22	25	30	35	38
Light Wall KG/CM ²	1.0 411	1.0 328	1.5 370	1.5 318	1.5 250	1.5 235	1.5 220	1.5 196	1.5 172	1.5 156	2.5 188	2.5 196	2.5 168	2.5 155
Med. Wall KG/CM ²		1.5 460	2.0 496	2.0 401			2.0 348	2.0 313	2.0 288	2.0 249	2.5 263			

COPPER TUBING - Hard Drawn Straight 5-6 Meter Lengths - Fig 873000 1-2 Meter Lengths - Fig 874000 Chrome plated

OD mm	6	8	10	12	14	15	16	18	20	22	25	28	35	42	54	67
Typical Wall KG/CM ²	.08 411	.08 328	.08 370	1.0 318	1.0 250	1.0 235	2.0 220	1.0 196	2.0 172	1.0 156	2.0 188	1.2 196	1.5 168	1.5 155	1.8	1.8

Note: Other walls available

COPPER TUBING - Soft Coils 10 Meter Coils - Fig 900000 Fig 900000C - Chrome plated

OD mm	4	6	8	10	12	15	16	18	22
Wall KG/CM ²	0.8 148	0.8 112	0.8 85	1.0 87	1.0 71	1.0 57	1.0 53	1.0 48/72	1.0 38/58

6

8

10

12

14

15

16

18

20

22

25

28

30

35

42

54

67

METRIC AND IMPERIAL TUBING AND FITTINGS

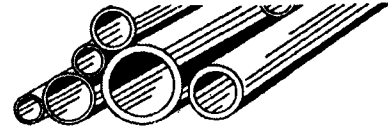

To BS 2871 Part 2

SIZES: 6mm to 508mm METRIC
1/2" to 24" IMPERIAL (not IPS)

Aluminum Brass 76/22/2 also known as "Yorcalbro"
(ASTM B111, CZ 100) and

CopperNickel 90/10 also known as CopperNickel Iron
(ATSM C70600, CN 102).

Aluminum brass has broad application in fuel oils and chemical service.
Coppernickel is used especially for bitumen type cargo systems or as an
upgrade for aluminum brass. Both are supplied in annealed temper.

Fittings for these piping systems are available in several types. Socket end
silver brazing fittings (shown) are supplied in aluminum brass with preinserted
silver brazing or capillary ring in small sizes (through 44.5 MM or 2"). Larger
fittings are gunmetal alloy LG2C. See pg 104 for a fuller description of fittings.

Buttweld fittings in aluminum brass or coppernickel are made in sizes above
44.5 mm or 2". Specify or add "BW" suffix to part numbers.

Tanker unions (shown below) offer a mechanical connection of two tubes
without requiring high heat that brazing or welding would require. This
mechanical connection is commonly used to repair tanker heating coil
systems where high heat would be ill advised. See pg 104.

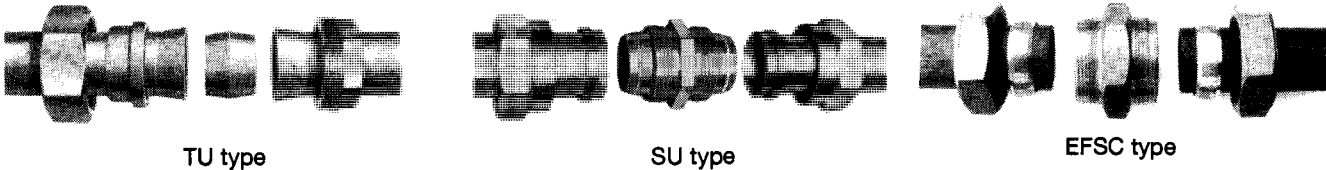

DIMENSIONS: Common Sizes and Walls*

METRIC SERIES (mm) Aluminum Brass (875000) and Coppernickel (875100)

Tube Size = Outside Diameter: mm	6	8	10	12	16	20	25	30	38	44.5	57	76.1	88.9	108	133	159
Wall Thickness: mm	0.8	0.8	0.8	0.8	1.0	1.0	1.5	1.5	1.5	1.5	2.0	2.0	2.5	2.5	2.5	2.5

IMPERIAL SERIES (Inches) Aluminum Brass (875001) and Coppernickel (875101)

Nominal Bore =	Inside Diameter:	1/2	3/4	1	1 1/4	1 1/2	2	2 1/2	3	3 1/2	4	5	6	
	Outside Diameter:	.596	.846	1.11	1.36	1.61	2.13	2.63	3.14	3.66	4.184	5.184	6.208	In
	mm:	15.1	21.5	28.2	34.6	40.9	54.0	66.7	79.8	93.0	106.27	131.67	157.68	mm
	Wall:	.048	.048	.056	.056	.056	.064	.064	.072	.080	.092	.092	.104	In
	mm:	1.22	1.22	1.42	1.42	1.42	1.63	1.63	1.83	2.03	2.34	2.34	2.64	mm
	Gauge:	18	18	17	17	17	16	16	15	14	13	13	12	SWG

Note: Other walls available for both Imperial and Metric
*Specify service pressure, temperature and medium.

METRIC FITTINGS COMPRESSION

SIZES: 6 to 42 mm

Bite Type Flareless Fittings to DIN 2353

L Designation is "Light" Series

S Designation is "Heavy" Series

See tube chart for pressure indications

ORDERING INFO: Material or Code + Fitting # and size

STEEL	841
BRASS	843
STAINLESS	845

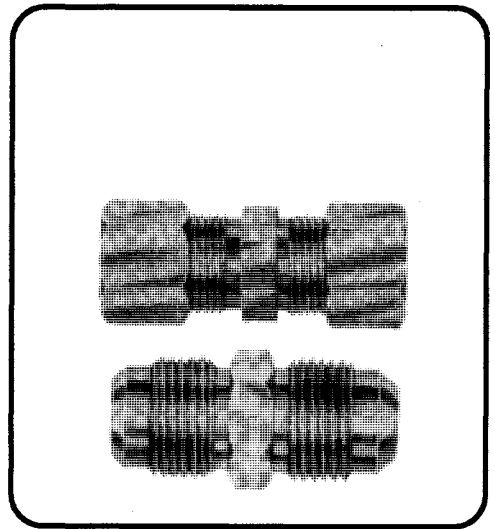

TUBE "D" mm	6	8	10	12	14	15	16	18	20	22	25	28	30	35	38
TYPICAL WALL mm	1.0 322	1.0 242	1.0 193	1.5 242	2.0 276	1.5 193	2.0 242	1.5 161	2.0 193	1.5 132	2.5 193	2.0 138	2.5 161	3.0 166	3.0
WITH OPERATING	1.5 483	1.5 363	1.5 280	2.0 322	2.5 345	2.0 258	2.5 302	2.0 215	2.5 242	2.0 176	3.0 232	3.0 207	3.0 193	4.0 221	4.0
PRESSURE (STEEL)	2.0 644	2.0 483	2.0 387	2.5 403	3.0 414	2.5 322	3.0 363	2.5 269	3.0 290	2.5 220	4.0 309	4.0 276	4.0 256	5.0 276	5.0
KG/CM ² 4:1 SAFETY															

SIZE	KG	"W"90	"T" Tee	"G" Union	"GEV (BSP)" Stud Cplg*	"GEV(NPT)" Stud Cplg	"GEV (M)" Stud Cplg*	Bulkhead Union	"K" Cross	Support Clamp	Cutting Ring	"D" Nut
6L	250	101006	121006	150006	160006	181008	162006	155008	185008	548806	298008	297006
6S	630	101006S	121006S	150006S	160006S	161006S	162006S	155006S	185006S		298006S	297006S
8L	250	101006	121008	150008	160008	161008	162008	155008	185008	548808	298008	297008
8S	630	101006S	121008S	150008S	160008S	161008S	162008S	155008S	185008S		298008S	297008S
10L	250	101010	121010	150010	160010	161010	162010	158010	185010	548810	298010	297010
10S	630	101010S	121010S	150010S	160010S	161010S	155010S	158010S	185010S		298010S	297010S
12L	250	101012	121012	150012	160012	161012	162012	155012	185012	548812	298012	297012
12S	630	101012S	121012S	150012S	160012S	161012S	162012S	155012S	185012S		298012S	297012S
14S	630	101014	121014	150014	160014	161014	162014	155014	185014	548814	298014	297014
15L	250	101015	121015	150015	160015	161015	162015	155015	185015	548815	298015	297015
16S	400	101016	121016	150016	160016	161016	162016	155016	185016	548816	298016	297016
18L	160	101018	121018	151018	160018	161018	162018	155018	185018	548818	298018	297018
20S	400	101020	121020	150020	160020	161020	162020	155020	185020	548820	298020	297020
22L	160	101022	121022	150022	160022	161022	162022	155022	185022	548822	298022	297022
25S	400	101025	121025	150025	160025	161025	162025	155025	185025	548825	298025	297025
28L	100	101028	121028	150028	160028	161028	162028	155028	185028	548828	298028	297028
30S	250	101030	121030	150030	160030	161030	162030	155030	185030	548830	298030	297030
35L	100	101035	121035	150035	160035	161035	162035	155035	185035	548835	298035	297035
38S	250	101038	121038	150038	160038	161038	162038	155038	185038	548838	298038	297038
42L	100	101042	121042	150042	160042	161042	162042	155042	185042	548842	298042	297042

* Specify tapered or parallel threads for male stud couplings GEV(BSP). GEV(M) is metric straight thread.

METRIC FLARE TYPE

SIZES: 6 to 16mm

Copper tube with flared tube ends required to utilize these fittings, each connection using a nut, supplied separately.

SIZE	90°	TEE	UNION	ADAPTER	NUT	TUBING
6	844106	844206	844306	844806	844906	900006
8	844108	844208	844308	844808	844908	900008
10	844110	844210	844310	844810	844910	900010
12	844112	844212	844312	844812	844912	900012
15	844115	844215	844315	844815	844915	900015
16	844116	844216	844316	844816	844916	900016

METRIC FLANGES & DIMENSIONS

Ordering info: Nom dia and DIN / JIS Class or part number

NOM DIA (mm)	DIN PN6 900106	DIN PN10 900110	DIN PN16 900116	DIN PN25 900125	DIN PN40 900140	JIS 5K 900005	JIS 10K 900010	JIS 16K 900016	JIS 20K 900020	JIS 40K 900040	NOM DIA (mm)
15	D 80 BC 55 H 4 x 11	95 65 4 x 14	95 65 4 x 14	95 65 4 x 14	95 65 4 x 14	80 60 4 x 12	95 70 4 x 15	95 70 4 x 15	95 70 4 x 15	115 80 4 x 19	15
20	90 65 4 x 11	105 75 4 x 14	105 75 4 x 14	105 75 4 x 14	105 75 4 x 14	85 65 4 x 12	100 75 4 x 15	100 75 4 x 15	100 75 4 x 15	120 85 4 x 19	20
25	100 75 4 x 11	115 85 4 x 14	115 85 4 x 14	115 85 4 x 14	115 85 4 x 14	95 75 4 x 12	125 90 4 x 19	125 90 4 x 19	125 90 4 x 19	130 95 4 x 19	25
32	120 90 4 x 14	140 100 4 x 18	140 100 4 x 18	140 100 4 x 18	140 100 4 x 18	115 90 4 x 15	135 100 4 x 19	135 100 4 x 19	135 100 4 x 19	140 105 4 x 19	32
40	130 100 4 x 14	150 110 4 x 18	150 110 4 x 18	150 110 4 x 18	150 110 4 x 18	120 95 4 x 15	140 105 4 x 19	140 105 4 x 19	140 105 4 x 19	160 120 4 x 23	40
50	140 110 4 x 14	165 125 4 x 18	165 125 4 x 18	165 125 4 x 18	165 125 4 x 18	130 105 4 x 15	155 120 4 x 19	155 120 8 x 19	155 120 8 x 19	165 130 8 x 19	50
65	160 130 4 x 14	185 145 4 x 18	185 145 4 x 18	185 145 8 x 18	185 145 8 x 18	155 130 4 x 15	175 140 4 x 19	175 140 8 x 19	175 140 8 x 19	200 160 8 x 23	65
80	190 150 4 x 18	200 160 8 x 18	200 160 8 x 18	200 160 8 x 18	200 160 8 x 18	180 145 4 x 19	185 150 8 x 19	200 160 8 x 23	200 160 8 x 23	210 170 8 x 23	80
100	210 170 4 x 18	220 180 8 x 18	220 180 8 x 18	235 190 8 x 22	235 190 8 x 22	200 165 8 x 19	210 175 8 x 19	225 185 8 x 23	225 185 8 x 23	250 205 8 x 25	100
125	240 200 8 x 18	250 210 8 x 18	250 210 8 x 18	270 220 8 x 26	270 220 8 x 26	235 200 8 x 19	250 210 8 x 23	270 225 8 x 25	270 225 8 x 25	300 250 8 x 27	125
150	265 225 8 x 18	285 240 8 x 22	285 240 8 x 22	300 250 8 x 26	300 250 8 x 26	265 230 8 x 19	280 240 8 x 23	305 260 12 x 25	305 260 12 x 25	355 295 12 x 33	150
175	295 255 8 x 18	315 270 8 x 22	315 270 8 x 22	330 280 12 x 26	350 295 12 x 30	300 260 8 x 23	305 265 12 x 23				175
200	320 280 8 x 18	340 295 8 x 22	340 295 12 x 22	360 310 12 x 26	375 320 12 x 30	320 280 8 x 23	330 290 12 x 23	350 305 12 x 25	350 305 12 x 25	405 345 12 x 33	200
250	375 335 12 x 18	395 350 12 x 22	405 355 12 x 26	425 370 12 x 30	450 385 12 x 33	385 345 12 x 23	400 355 12 x 25	430 380 12 x 27	430 380 12 x 27	475 410 12 x 33	250
300	440 395 12 x 22	445 400 12 x 22	460 410 12 x 26	485 430 16 x 30	515 450 16 x 33	430 390 12 x 23	445 400 16 x 25	480 430 16 x 27	480 430 16 x 27	540 470 16 x 39	300
350	490 445 12 x 22	505 460 16 x 22	520 470 16 x 26	555 490 16 x 33	580 510 16 x 36	480 435 12 x 25	490 445 16 x 25	540 480 16 x 33	540 480 16 x 33	585 515 16 x 39	350
400	540 495 16 x 22	565 515 16 x 26	580 525 16 x 30	620 550 16 x 36	660 585 16 x 39	540 495 16 x 25	560 510 16 x 27	605 540 16 x 33	605 540 16 x 33	645 570 16 x 39	400
450	595 550 16 x 22	615 565 20 x 26	640 585 20 x 33	670 600 20 x 36	755 670 20 x 42	605 555 16 x 25	620 565 20 x 27	675 605 20 x 33			450
500	645 600 20 x 22	670 620 20 x 26	715 650 20 x 33	730 660 20 x 36	795 670 20 x 42	655 605 20 x 25	675 620 20 x 27	730 660 20 x 33		D BC H	500

D: Flange Diameter
BC: Bolt Circle Diameter
H: Bolt Holes x Hole Diameter

1 inch = 25.4 mm



U. S. Naval vessel Philippine Sea, Aegis missile cruiser constructed Bath Iron Works, Maine, LOA 173' (56.7m), beam 55' (15.76m), 9468 tons full-load. Four gas turbines generate 80,000 shaft horse power. Range 6,000 nautical miles, complement 385.

NOTES

MIL-SPEC NUMBERS	PAGE
MIL STD-22D	192
T-960	170
P-1144	191
H-1149	169
F-1183	177
V-1189	147-148
T-1368	191
V-2042	164
T-2118	170
S-2953	163
V-2961	164
V-3155	167
MIL-T -15005	193
V-15020	174
V-15508	168
C-15726	120
S-16293	163
T-16420	193
B-16541	120
V-16556	176
R-16743	165
V-17501	168
V-17547	151,168
V-17737	156
MIL F -17823	190
V-17848	166
S-17849	163
V-18030	166
V-18110	154,157
T-18165	193
V-18436	157
G-18916	166
V-19772	165,167
MIL I -20031	171
F-20042	175,189
V-20065	162,165
T-20157	191
F-20236	183
F-20670	190
V-22052	157,158
V-22094	155
V-22133	159
V-22549	162
V-22687	161
MIL T -24107	193
V-24109	153
E-24127	174
F-24202	181
F-24227	177
V-24332	162
V-24384	164
V-24509	160,161
V-24569	176
V-24578	171
V-24586	171
V-24624	159
MIL P -24691	191

ASTM NUMBERS	PAGE
B-42, 43	191
B-61	147
B-88	111
A-105	190
A-106	191
B-165	191
A-182	190
A-312	191
A-335	191
A-376	191
B-466	193

DWG NUMBERS	PAGE
DWG 64496	190
461052	169
841337	179
338	179
499	163
623	179
DWG 1385541	149
623	150
637	151
673	150
707	175
711	152
721	152
714	143
712	145
766	179
781	192
789	172
792	186
DWG 1385842	179
846	179
859	179
861	190
863	179
866	192
880	181
883	179
886	179
892	189
DWG 1385901	169
912	184
913	186
941	179
942	179
943	179
944	179
946	179
950	184
992	189
DWG 1749102	159
103	159
1889587	146
620	186
635	186
868	173
2068540	184
2145801	192
526	173
DWG 2177525	155
917	148
934	146
2424406	192
424	192
3160733	186
3285813	175
820	175
821	175
831	173
846	173
DWG 4384536,	142
4444650	173
4715319	189
320	186
5001003	161
004	161
048	163
057	169
5184193	155
DWG 5959276	169

INDEX	PAGE
ANGLE VALVES	
BRONZE	144,153
STEEL	155-158
BALL VALVES	161
BELLMOUTH	186
BOILER VALVES	156
BUTTERFLY VALVES	159
CHECK VALVES	
BRONZE	145-151
STEEL	157,158,169
COMMERCIAL INDEX	3
COPPERNICKEL PIPE	193
DATA LISTS	203-222
DECK ACCESS BOX	173
DECK DRAINS, SLEEVES	172,192
DOME LOADED VALVE	164
DUMP VALVE	176
EDUCTOR	174
EDWARDS® VALVES	43-44,51-52
FITTINGS	
COPPERNICKEL	180-185
SILBRAZE	177-179
THREADED	184-185
WELD-ALLOYS	183-185
FLANGES	178,185-190
DIMENSION CHART	197-202
FLUSH VALVES	174
FUNNELS	186
GAGE VALVES, FTGS	184
GATE VALVES	
BRONZE	143-152
STEEL	154-158
GLOBE VALVES	
BRONZE	144-153
STEEL	155-158,176
HOSE VALVES, FTGS	152,173,187
LESLIE® VALVES	166
LIQUID GAUGE VALVE	171
MAGAZINE SPRINKLER	168
MEASURFLO®	174
METALS	119-121
MISCELLANEOUS	169,173
MONEL JIC	187
NEEDLE VALVE	171
O-SEAL VALVE, FTGS	153,187
OUTLETS	184
PIPE HANGERS, RINGS	192
PIPE & TUBING	191-195
PLUG VALVES	160
PRESSURE REDUCING	164-166
PRESSURE SEAL	158
PRIORITY VALVE	164
QUICK CLOSING VALVE	176
QUICK CONNECT FTGS	173
RELIEF VALVES	162
REGULATORS	165-166
SCUPPER VALVES	175
SOLENOID VALVES	176
STEAM TRAPS	170
STRAINERS	163,169
TEMPERATURE REG.	167
TUBING	193
UNION END VALVES	143-145, 153
VENTILATION BUTTERFLY	160



BRONZE GATE UNION END

DWG 1385714

SIZES: 1/4" to 2"

DESIGN DESCRIPTION

Union Ends	1/2" thru 2" size with monel seat rings
Non-rising Stem	1/4" and 3/8" sizes with integral bronze seats
Threaded Bonnet	Silbrazed tailpieces to MIL-F-1183
Monel Stem and Disc	

PARTS AND MATERIAL LIST:

DESCRIPTION	MATERIAL	SPECIFICATION
body	cast valve bronze	ASTM B61
bonnet	cast valve bronze	ASTM B61
seat ring	ni-cu alloy	QQ-N-288
wedge	ni-cu alloy	QQ-N-288
stem	ni-cu alloy	QQ-N-281
packing gland	phosphor bronze	QQ-B-750
retainer ring	cast valve bronze	ASTM B61
union "O" ring	buna-N rubber	MIL-P-83461
	rubber (EPR)	E515-80 or equal
packing	TFE imp. asbestos	commercial
union nut	cast valve bronze	ASTM B61
union tailpiece		
(silbrazed)	valve bronze	ASTM B61
(socketweld)	cu-ni alloy	MIL-C-15726
	stainless	ASTM A182
(buttweld)	ni-cu	QQ-N-281
	cu-ni alloy	MIL-C-15726
stuffing box	cast valve bronze	ASTM B61
stuffing nut	cast valve bronze	ASTM B61

OPTIONAL FEATURES:

These valves are normally furnished with bronze silbrazed tailpieces. Tailpieces can also be furnished with socketweld or buttweld ends in 90/10 or 70/30 coppernickel, monel, or stainless.

The "O" Rings (one each at the body and tailpiece joint) can be furnished in the following materials:

1. BUNA-N—For oil service.
2. "EPR"—For water, gas or steam service.

Available with lockshield and key.
Available with stem position indicator.

PRESSURE/TEMPERATURE RATINGS

200 psi wsp 425° F
400 psi wog 150° F

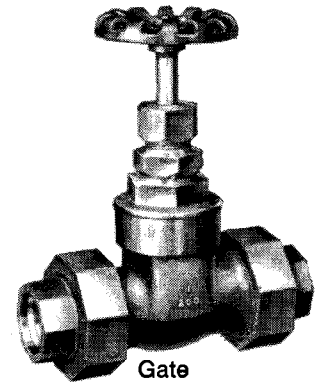

Gate
414101

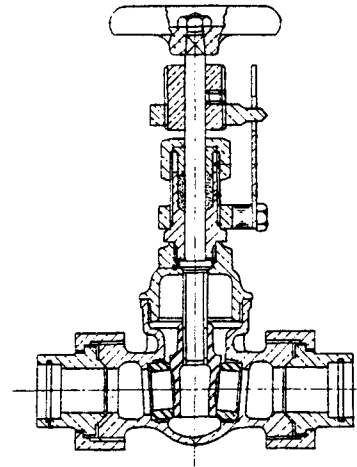

With Indicator
414261

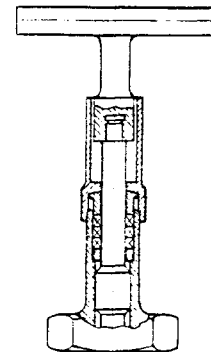

With Lockshield
414161

BRONZE GLOBE & ANGLE UNION END

DWG 4384536

SIZES: 1/4" to 2"

DESIGN DESCRIPTION: CLASS A

Union Ends	Monel Trim
Union Bonnet	Globe and Stop Check versions
Hard Disc	

Bronze body, bonnet, and bonnet ring, with a monel stem, seat ring and disc. There are "O" rings in the body-to-bonnet joint and the union ends. The standard valve has silbraze tailpieces to MIL-F-1183. Available in needle globe design.

DESIGN DESCRIPTION: CLASS B

Union Ends	Monel Trim
Union Bonnet	Globe, and Stop Check versions
Soft Disc	

Bronze body, bonnet, and bonnet ring, with a monel stem and seat ring and monel disc with Kel F insert. There are "O" rings in the body-to-bonnet joint and in the union ends. Standard valve has silbraze tailpieces to MIL-F-1183.

PARTS AND MATERIAL LIST:

DESCRIPTION	MATERIAL	SPECIFICATION
body	valve bronze	ASTM B61
bonnet	valve bronze	ASTM B61
bonnet ring	comp. bronze	ASTM B62
disc (Class A)	ni-cu alloy	QQ-N-288
disc assembly (Class B)		
disc holder	ni-cu alloy	QQ-N-288
soft disc	Kel-F	commercial
disc retainer	ni-cu alloy	QQ-N-288
disc ret. scr. (1/4"-3/4")	ni-cu alloy	QQ-N-281
disc ret. nut (1"-2")	ni-cu alloy	QQ-N-281
disc locknut (1"-2")	comp. bronze	ASTM B62
seat ring	ni-cu alloy	QQ-N-288
stem	ni-cu alloy	QQ-N-281
gland	phosphor bronze	QQ-B-750
stuffing nut	comp. bronze	ASTM B62
packing	TFE imp. asbestos	commercial
handwheel	aluminum	commercial
union nut	valve bronze	ASTM B61
union tailpiece		
silbraze	valve bronze	ASTM B61
socketweld	cu-ni alloy	MIL-C-15726
	stainless	ASTM A182
butt weld	ni-cu alloy	QQ-N-281
	cu-ni alloy	MIL-C-15726
bonnet "O" ring	buna-N	MIL-P-83461
union "O" ring	buna-N	MIL-P-83461
"O" ring retainer	bronze	ASTM B61

PRESSURE / TEMPERATURE RATINGS

400 psi wog 150° F

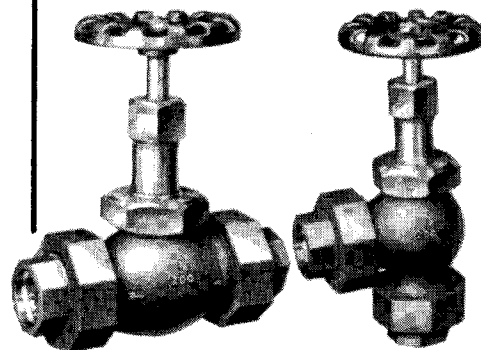

Globe

Angle

FIG. NUMBERS:

Globe	Class A	414301
	Class B	414303
Globe	Stopcheck Class A	414302
	Stopcheck Class B	414304
Globe	Needle Class A	414305
Angle	Class A	414401
	Class B	414403
Angle	Stopcheck Class A	414402
	Stopcheck Class B	414404

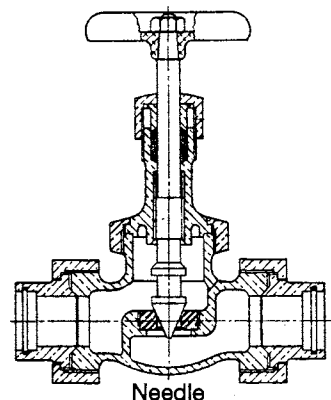

Needle

OPTIONAL FEATURES:

These valves are normally furnished with sil-braze tailpieces. Tailpieces can also be furnished with socketweld or butt weld ends in 90/10 or 70/30 coppernickel, monel or stainless.

The "O" Rings (one each at the body and tailpiece joint) can be furnished in the following materials:

1. BUNA-N—For oil service.
2. "EPR"—For water, gas or steam service.

Valve can be supplied with a flow control device and a lockshield and key.

BRONZE SWING CHECK UNION END

DWG 1385721, 5384536

SIZES: 1/4" to 2"

DESIGN DESCRIPTION

Union Ends
Monel Disc
Regrinding Seat

Bronze union end swing check valve has a monel disc, side plugs, hinge pin, and disc nut. The standard valve has silbrazed tailpieces grooved for, but furnished without, silbrazed rings.

Also available in horizontal lift check design to DWG 5384536.

PRESSURE / TEMPERATURE RATINGS

200 psi wsp 425° F
400 psi wog 150° F

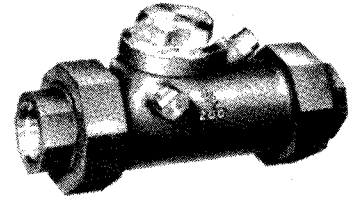

Swing Check
414501

PARTS AND MATERIAL LIST:

DESCRIPTION	MATERIAL	SPECIFICATION
body	cast valve bronze	ASTM B61
cap	cast valve bronze	ASTM B61
disc	ni-cu alloy	QQ-N-288
disc nut	ni-cu alloy	commercial
disc pin	ni-cu alloy	commercial
hanger	cast valve bronze	ASTM B61
side plug	ni-cu alloy	QQ-N-281
union nut	cast valve bronze	ASTM B61
union "O" ring	buna-N rubber	MIL-P-83461
union tailpiece		
silbrazed	cast valve bronze	ASTM B61
socketweld	cu-ni alloy or stainless	MIL-C-15726 ASTM A182
butt weld	cu-ni alloy or ni-cu	MIL-C-15726 QQ-N-288
retainer ring	cast valve bronze	ASTM B61

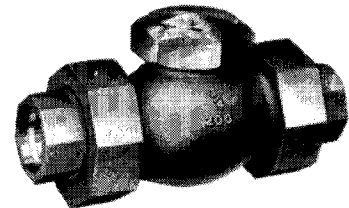

Lift Check
414601

OPTIONAL FEATURES:

Bronze union end valves are normally furnished with silbrazed tailpieces. Tailpieces can also be furnished with socketweld or butt weld ends in 90/10 or 70/30 coppennickel, monel or stainless.

The "O" rings, one each at the body and tailpiece joint, can be furnished in the following materials:

1. BUNA-N—For oil service.
2. "EPR"—For water, gas or steam service.

BRONZE GATE, GLOBE, ANGLE & STOP CHECK 700 LB

DWG 1889587

SIZES: 1/4" to 2"

DESIGN DESCRIPTION

Bronze body, bonnet and bonnet ring
 Union bonnet
 Monel trim
 Silbraze ends
 KEL-F disc (Globe and Angle)
 Flow control device available

PRESSURE / TEMPERATURE RATINGS
 700 PSI WOG 180° F

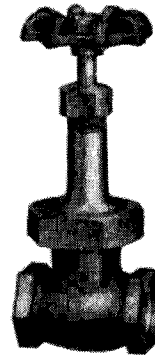

Gate 427101

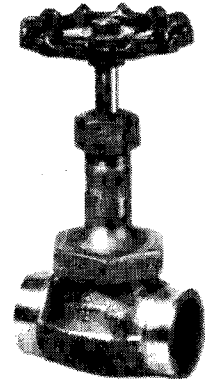

Globe 427301
 Angle 427401



Check
 427601

COPPER-NICKEL GLOBE, ANGLE & CHECK 700 LB

DWG 2177934

SIZES: 1/4" to 2"

DESIGN DESCRIPTION

Forged copper-nickel body and bonnet
 Union bonnet
 Monel trim
 KEL-F disc (Globe and Angle)
 Socketweld or silbraze ends
 Flow control device available

PRESSURE / TEMPERATURE RATINGS
 700 PSI WOG 250° F

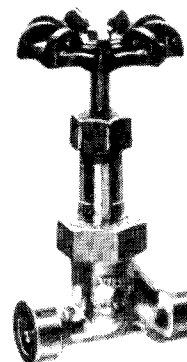

Globe
 447301

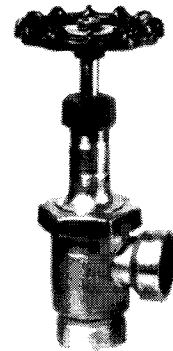

Angle
 447401

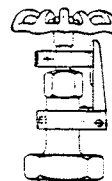

Flow Control
 Device

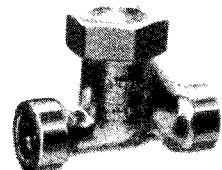

Check
 447601

BRONZE GATE NAVY

100 WOG

MIL-V-1189 TYPE I, CLASS 1 (OSY)
TYPE II, CLASS 1 (NRS)

SIZES: 1" to 12"

DESIGN DESCRIPTION

Bronze (B-61) body and bonnet
Monel trim
Outside screw and yoke (OSY) or non-rising Stem (NRS)
Bolted bonnet
Flanged ends (Mil-F-20042)

Hose outlet available on 1 1/2 and 2 1/2 sizes: order 411101-H
Dwg 2145526: Quick disconnect adapter: order 411101-QD

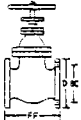

DIMENSIONS (INCHES)

Size	1	1 1/4	1 1/2	2	2 1/2	3	3 1/2	4	4 1/2	5	6	7	8	9	10
FF	5	5 1/4	5 1/2	5 3/4	6	6 1/4	6 1/2	6 3/4	7	7 1/2	8	8 3/4	9 1/2	10 1/2	11
D	4 1/4	4 1/2	5 1/16	5 9/16	6 1/8	6 5/8	7 3/16	7 11/16	8 3/16	9 1/16	10 1/8	11 5/16	12 3/8	13 15/16	15
BC	3 1/8	3 3/8	3 15/16	4 7/16	5	5 1/2	6 1/16	6 9/16	7 1/16	7 13/16	8 7/8	10	11 1/8	12 3/8	13 7/16
Holes	4	4	6	6	6	8	8	8	10	10	12	12	14	14	15
wt	12	19	19	21	29	44	52	68	93	95	110	180	249	340	403

PRESSURE/TEMPERATURE RATINGS
100 PSI WOG 425°F

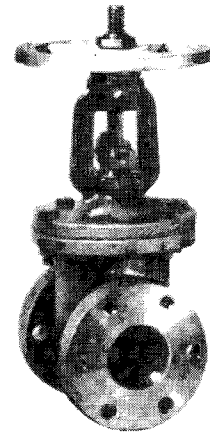

OSY - 411101
NRS - 411201

BRONZE GATE NAVY

30 WOG

MIL-V-1189 TYPE I, CLASS 4 (OSY)
TYPE II, CLASS 4 (NRS)

SIZES: 12" to 48"

These low pressure Navy drilled gate valves are available in a full range of sizes from 12" to 48". Flanges are drilled in accordance with MIL-F-20042 Class 50: as listed on page 188. Gear operators or motor actuators are also available.

PRESSURE/TEMPERATURE RATINGS
30 PSI WOG 425°F

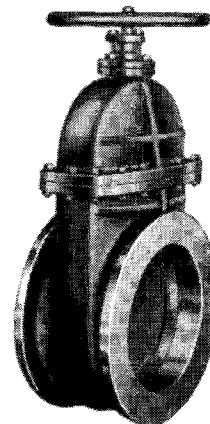

OSY - 410101
NRS - 410201

NAVY BRONZE GATE

250 WOG

MIL-V-1189 TYPE I, CLASS 2

DWG 2177917 SIZES: 2 1/2, 3, 4, 5, 6, 8, 10, 12

DWG 1385602 SIZES: 2, 3 1/2, 7, 9

SIZES: 2" to 12"

DESIGN DESCRIPTION

Bronze body and bonnet
 Bolted bonnet
 Outside screw and yoke
 Monel trim
 Flanged ends (Mil-F-20042)

DIMENSIONS (INCHES)

Size	2	2 1/2	3	3 1/2	4	5	6	7	8	9	10	12
FF	5 3/4	6	6 1/4	6 1/2	6 3/4	7 1/2	8	8 3/4	9 1/2	10 1/2	11	12 1/2
D	5 9/16	6 1/8	6 5/8	7 3/16	7 11/16	9 1/16	10 1/8	11 5/16	12 3/8	13 15/16	15	17 5/8
BC	4 7/16	5	5 1/2	6 1/16	6 9/16	7 13/16	8 7/8	10	11 1/16	12 3/8	13 7/16	16 1/16
Holes	6	6	8	8	8	10	12	12	14	14	15	18
wt	39	50	56	69	80	126	158	180	277	340	445	702

NAVY BRONZE GATE

400 WOG

MIL-V-1189 TYPE I, CLASS 3 (OSY)

TYPE II, CLASS 3 (NRS)

SIZES: 1" to 8"

DIMENSIONS (INCHES)

Size	1	1 1/4	1 1/2	2	2 1/2	3	3 1/2	4	4 1/2	5	6	8
FF	5	5 1/4	5 1/2	5 3/4	8	8 1/2	9	9 1/2	10	10 1/4	10 3/4	11 3/4
D	4 1/4	4 1/2	5 1/16	5 9/16	7 9/16	8 1/8	8 11/16	9 1/4	9 13/16	10 3/8	11 15/16	14 3/4
BC	3 3/4	4 1/16	4 5/8	5 3/16	6	6 9/16	7 1/8	7 11/16	8 1/4	8 13/16	10 3/16	12 3/4
Holes	5	5	6	7	8	8	9	9	10	11	12	13
wt	13	29	32	40	65	74	84	94	148	157	200	280

PRESSURE / TEMPERATURE RATINGS

250 psi wog 150F
 150 psi wog 425F

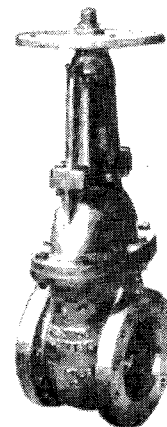

412101

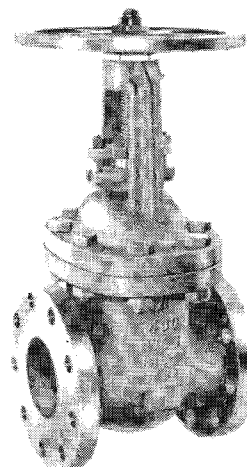
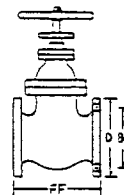

413101 OSY
 413201 NRS

BRONZE GLOBE, ANGLE AND CROSS 100 WOG NAVY

DWG 803-1385541
(Formerly B-135)

SIZES: 1/2" to 12"

DESIGN DESCRIPTION

Bronze body and bonnet
 Union bonnet (size 1/2" to 1-1/2")
 Bolted bonnet (size 2" and larger)
 Bronze disc standard. Monel disc also available
 Bronze integral seat (1/2" - 3" standard)
 Monel seat rings (size 3 1/2" and larger)
 Monel stem (all sizes)
 Stop check available
 Full monel trim available
 Flanged ends (Mil-F-20042, 150 LB)

PRESSURE / TEMPERATURE RATINGS

100 psi wog 425F

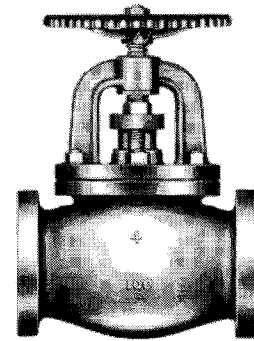

Globe
411301

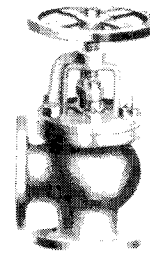

Angle
411401

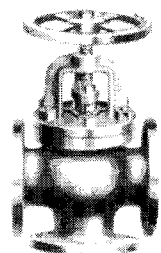

Cross
411404

DIMENSIONS (INCHES): GLOBE (FF), ANGLE (CF)

Size	1/4	1/2	3/4	1	1 1/4	1 1/2	2	2 1/2	3	3 1/2	4	5	6	8	10	12
FF	4 1/2	4 3/4	5 1/4	5 3/4	6 1/4	6 3/4	8	9	10	11 1/2	12 1/2	14 3/4	17	21 1/2	26	29 1/4
CF	2 1/4	2 3/8	2 5/8	2 7/8	3 1/8	3 3/8	4	4 1/2	5	5 1/2	6	7 1/8	8	9 3/4	11 3/4	13 3/8
D	3 1/4	3 9/16	3 13/16	4 1/4	4 1/2	5 1/16	5 9/16	6 1/8	6 5/8	7 3/16	7 11/16	9 1/16	10 1/8	12 3/8	15	17 5/8
BC	2 1/8	2 7/16	2 11/16	3 1/8	3 3/8	3 15/16	4 7/16	5	5 1/2	6 1/16	6 9/16	7 13/16	8 7/8	11 1/16	13 7/16	16 1/16
Holes	3	3	4	4	4	6	6	6	8	8	8	10	12	14	15	18
wt	5	5	8	12	15	20	30	35	45	55	60	100	130	250	430	590

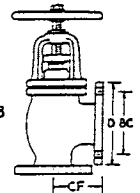

BRZ INVERTED GLOBE LIFTCHECK VALVE 100 WOG NAVY

SIZES: 1" to 4"

Designed to various Buships DWGs

Bronze body
 Bolted bonnet
 Flanged ends (MIL-F-20042, 150 LB)

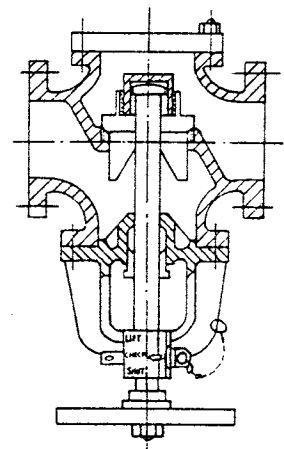

Fig 411901

BRONZE GLOBE ANGLE AND CROSS 200 PSI / 400 WOG NAVY

DWG 803-1385673
(Formerly B-136)

SIZES: 1/2" to 12"

DESIGN DESCRIPTION

Bronze body, bonnet and stem
Bolted bonnet
Manganese bronze disc
Full Monel trim available
Stop check available
Flanged ends (Mil-F-20042, 200 LB/400 WOG)

DIMENSIONS (INCHES)

Size	1/4	1/2	3/4	1	1 1/4	1 1/2	2	2 1/2	3	3 1/2	4	5	6
FF	6 1/4	7	7 1/2	8 1/2	8 3/4	10 1/4	11 1/2	12 1/2	13	13 3/4	15	16 3/4	18 3/4
CF	3 1/8	3 1/2	3 3/4	4 1/4	4 3/8	5 1/8	5 3/4	6 1/4	6 1/2	6 7/8	7 1/2	8 3/8	9 3/8
D	3 3/4	4	4 5/16	5 1/16	5 3/8	5 15/16	6 1/2	7 9/16	8 1/8	8 11/16	9 1/4	10 3/8	11 15/16
BC	2 5/8	2 7/8	3 3/16	3 3/4	4 1/16	4 5/16	5 3/16	6	6 9/16	7 1/8	7 11/16	8 13/16	10 3/16
Holes	3	4	4	5	5	6	7	8	8	9	9	11	12
wt	13	18	22	27	35	47	63	86	110	130	165	260	360

PRESSURE / TEMPERATURE RATINGS

200 psi wsp

425° F

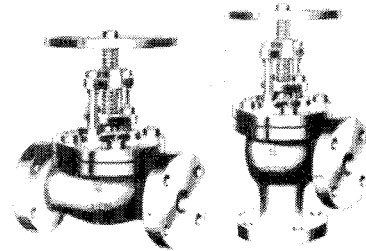

Globe - 412301
Angle - 412401
Cross - 412404

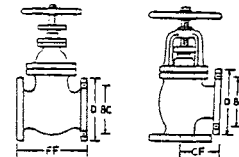

BRONZE Y-GLOBE NAVY 250 WOG

DWG 803-1385623

DESIGN DESCRIPTION

Bronze body and bonnet
Bolted bonnet
Monel trim with nylon KEL-F or monel disc - see trim choices
Flanged ends (Mil-F-20042, 250 LB)

Stop check not available in this configuration.

DIMENSIONS (INCHES)

Size	2 1/2	3	3 1/2	4	5	6	8	10
FF	9	10	11 1/2	12 1/2	14 3/4	17	21 1/2	26
D	6 1/8	6 5/8	7 3/16	7 11/16	9 1/16	10 1/8	12 3/8	15
BC	5	5 1/2	6 1/16	6 9/16	7 13/16	8 7/8	11 1/16	13 7/16
Holes	6	8	8	8	10	12	14	15
wt	48	75	95	110	155	200	370	500

PRESSURE / TEMPERATURE RATINGS

250 psi wsp

160° F

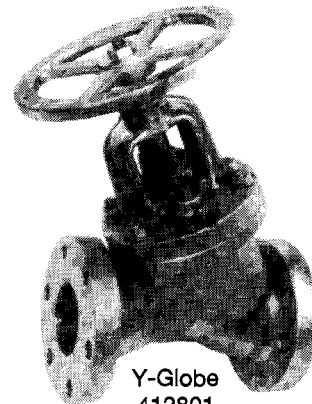

Y-Globe
412801

Trim Choice

- TYPE 1- Nylon disc without retainer
- TYPE 2- NI-CU disc with throttle retainer
- TYPE 3- KEL-F disc without retainer
- TYPE 4- KEL-F disc with retainer
- TYPE 5- KEL-F disc with throttle retainer
- TYPE 6- NI-CU disc without throttle retainer

BRONZE SWING CHECK

100 WOG NAVY

MIL-V-17547 TYPE A CLASS 1

SIZES: 1" to 12"

Bronze body with bronze or monel trim. Small sizes typically supplied with threaded cap but available with bolted cap upon request.

PARTS AND MATERIAL LIST

DESCRIPTION	MATERIAL	SPECIFICATION
disc	bronze or monel	MIL-B-16541/QQ-N-281
hanger	bronze	MIL-B-16541
hinge pin	monel	QQ-N-281
cover (cap)	bronze	MIL-B-16541
disc nut	monel	QQ-N-281
disc nut pin	monel	QQ-N-281
body	bronze	MIL-B-16541
cover gasket	non-asbestos	commercial
disc washer	monel	QQ-N-281
side plug	monel	QQ-N-281

* Available with monel seat ring

DIMENSIONS (INCHES)

	1	1 1/4	1 1/2	2	2 1/2	3	3 1/2	4	5	6	8	10	12
FF	55/8	6	6 1/4	7 5/16	8 5/16	9	10 15/16	11 3/4	13 1/2	15 1/2	19 1/2	22	24
D	4 1/4	4 1/2	5 1/16	5 9/16	6 1/8	6 5/8	7 3/16	7 11/16	9 1/16	10 1/8	12 3/8	15	17 5/8
BC	3 1/8	3 3/8	3 15/16	4 7/16	5	5 1/2	6 1/16	6 9/16	7 13/16	8 7/8	11 1/16	13 7/16	16 1/16
Holes	4	4	6	6	6	8	8	8	10	12	14	15	18
wt	8	10	14	20	33	40	49	65	88	130	210	360	450

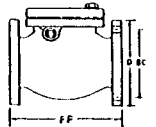

FF dimensions may vary by brand and design

BRONZE SWING CHECK

250 WOG NAVY

MIL-V-17547 TYPE A CLASS 2 (for Type B Class 2 see pg 168)
DWG 803-1385637

SIZES: 2" to 12"

Bronze body with monel trim. Bolted cap.

DIMENSIONS (INCHES)

Size	2	2 1/2	3	3 1/2	4	5	6	8	10	12
FF	9 1/4	10	10 3/4	11 1/2	12 1/4	13 3/4	15 1/4	18 1/2	21 3/4	25 1/4
D	5 9/16	6 1/8	6 5/8	7 3/16	7 11/16	9 1/16	10 1/8	12 3/8	15	17 5/8
BC	4 7/16	5	5 1/2	6 1/16	6 9/16	7 13/16	8 7/8	11 1/16	13 7/16	16 1/16
Holes	6	6	8	8	8	10	12	14	15	18
wt	44	48	58	69	78	110	150	275	330	500

PRESSURE / TEMPERATURE RATINGS

100 psi wog

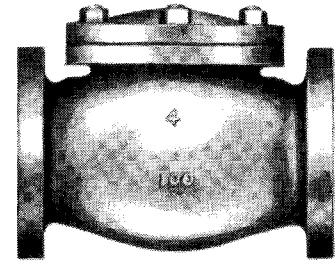

Swing Check
411501

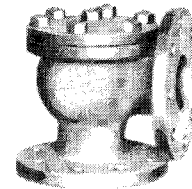

Angle Check
411801



Vertical Check
411701

PRESSURE / TEMPERATURE RATINGS

250 psi wog

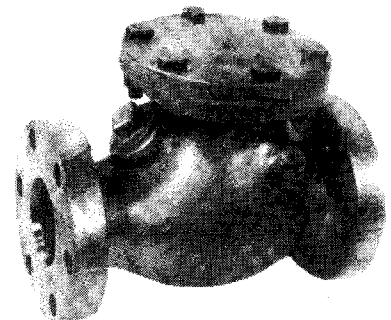

Swing Check
412501

BRONZE HOSE GLOBE AND HOSE ANGLE NAVY 250 LB

DWG 1385711 UNION BONNET
DWG 1385712 OS&Y

SIZES: 1 1/2" and 2 1/2"

DESIGN DESCRIPTION

Bronze body and bonnet
Union bonnet (1 1/2")
Outside screw and yoke (2 1/2")
Rubber disc
Monel stem, disc pin, disc retaining nut, and split pin
Available with 100 LB or 250 LB Navy flange
Also available with 150 LB or 300 LB Commercial flange (see page 21)

DIMENSIONS (INCHES)

Size	1 1/2	2 1/2
D	5 1/16	6 1/8
BC	3 15/16	5
Holes	6	6
wt	18	38

HOSE FITTINGS, ADAPTERS AND FLANGES

Hose fittings, flanges, and adapters are available in a wide variety of configurations. End connections are generally flanged, silbrazed, male or female thread by hose thread. Please specify hose thread type.

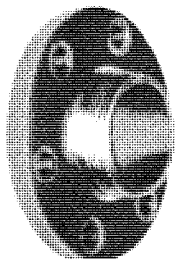

Hose Flange

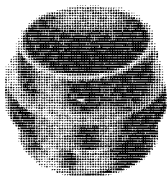

Male Silbrazed x
Male Thread

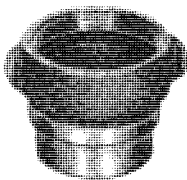

Male Silbrazed x
Female Thread

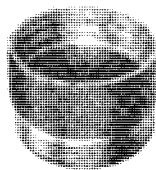

Female Silbrazed x
Male Thread

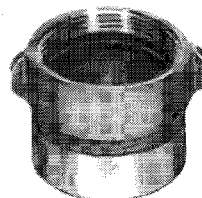

Female Silbrazed x
Female Thread



Cap



Plug

PRESSURE / TEMPERATURE RATINGS

250 psi wog

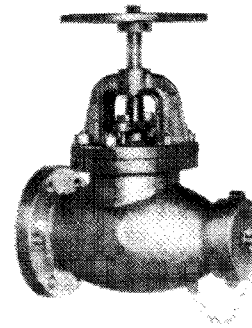

412371 Hose Globe

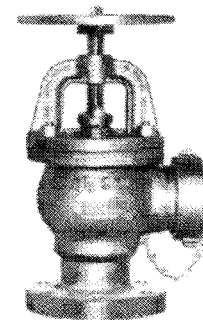

412471 Hose Angle

NAVY HOSE THREAD (Specification 34-F3)

Hose Size	Male Thread OD	Threads/inch
1 1/2	1.875	1 1/2
2 1/2	3.0386	7/2

1 1/2 = NPSH (IPT) Threads
2 1/2 = NH (NST) Threads

For threaded adapters see page 78

UNION END GLOBE ANGLE & CHECK 6000 LB

MIL-V-24109

For high pressure liquid, air, and steam applications. Body and bonnet are aluminum bronze, trim monel with KEL-F soft seating. Valves are normally supplied without end nuts or tailpieces.

ORDERING INFO:

Specify nut and tail: Bronze, Stainless, Coppernickel or Monel.
Tail style: Silbraze, Socket weld, Threaded or Buttweld.

Globe (Straight)	416301	1/8" - 2"
Globe (Offset)	416302	1/8" - 2"
Needle Type	416304	1/8" - 2"
Angle	416401	1/8" - 2"
Lift Check	416601	1/4" - 1 1/4"
Vertical Check	416801	1/4" - 1 1/4"

Fittings available for use with 6000 PSI valves see page 187

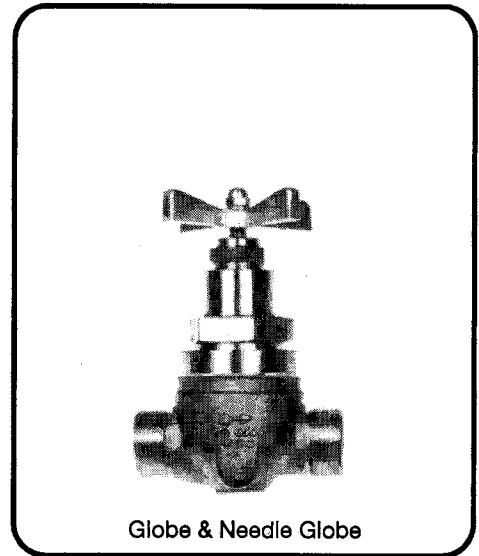

Globe & Needle Globe



Offset
Globe



Lift
Check



Angle
Valve

3000 LB

Bronze body with steel nuts and bronze silbraze tailpieces.
Monel trim with nylon soft seating.

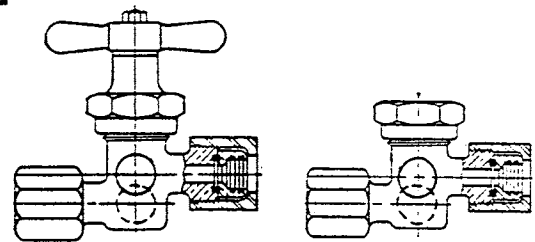

Globe - 418301
Angle - 418401
Check - 418601

1000 LB

Bronze body with steel nuts and bronze silbraze tailpieces.
Monel trim with nylon soft seating.

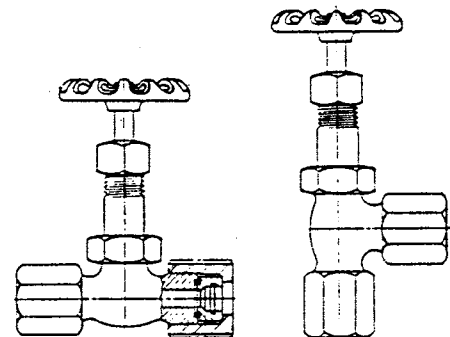

Globe - 417301
Angle - 417401

FORGED STEEL GATE

150, 300, 600 & 1500 LB

MIL-V-18110

SIZES: 1/4" to 2"

DESIGN DESCRIPTION

BODY: A105, F11 or Stainless
TRIM: Stellite HF

Bolted bonnet
Outside screw and yoke
Flanged, socket weld, or threaded ends
Monel stem, disc available

Level 1 available

SOCKET WELD ENDS:

600 LB	A105 (Comp D)	233131
	F11 (Comp B)	243131
	Stainless	233137
1500 LB	A105 (Comp D)	236131
	F11 (Comp B)	246131

FLANGED ENDS:

150 LB	A105 (Comp D)	251111
300 LB	A105 (Comp D)	252111
600 LB	A105 (Comp D)	253111
150 LB	Stainless	251117
300 LB	Stainless	252117

DIMENSIONS: FLANGED

SIZE		1/2	3/4	1	1 1/4	1 1/2	2
150LB	FF	4 1/4	4 5/8	5	5 1/2	6 1/2	7 1/2
	D	3 1/2	3 7/8	4 1/4	4 5/8	5	6
	BC	2 3/8	2 3/4	3 1/8	3 1/2	3 7/8	4 3/4
	Holes	4	4	4	4	4	4
300LB	FF	5 1/2	6	6 1/2	7 1/2	7 1/2	8 1/2
	D	3 3/4	4 5/8	4 7/8	5 1/4	6 1/8	6 1/2
	BC	2 5/8	3 1/4	3 1/2	3 7/8	4 1/2	5
	Holes	4	4	4	4	4	8
600LB	FF	6 1/2	7 1/2	8 1/2	9	9 1/2	11 1/2
	D	3 3/4	4 5/8	4 7/8	5 1/4	6 1/8	6 1/2
	BC	2 5/8	3 1/4	3 1/2	3 7/8	4 1/2	5
	Holes	4	4	4	4	4	8

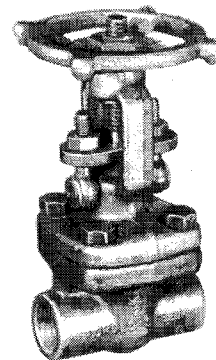

Socketweld

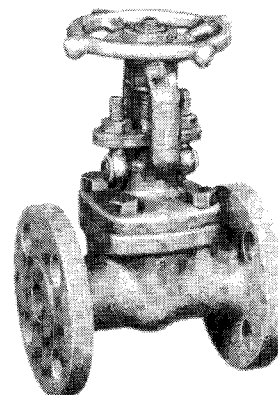

Flanged End

FORGED ALLOY STEEL GLOBE AND ANGLE

MIL-V-22094 (600, 1500, 2500 LB)
A105 (COMP D), F11 (COMP B), OR STAINLESS

DWG 2177525 (900 LB) A105, STAINLESS OR MONEL
DWG 5184193 (1500 LB) F11 CHROMEMOLY

SIZES: 1/2" to 2"

DESIGN DESCRIPTION

Bolted bonnet
Outside screw and yoke
Flanged or socketweld ends

Level 1 available
Stop check available
Needle design available

SOCKET WELD ENDS:

				Globe	Angle
MIL-V-22094	Comp D A105	600 LB		233331	233431
		1500 LB		236331	236431
		2500 LB		239331	—
DWG 2177525	Comp B F11	600 LB		243331	243431
		1500 LB		246331	246431
		900 LB		235331	235431
DWG 5184193	F11	900 LB		235337	235437
		900 LB		295331	295431
		1500 LB		246338	246438

FLANGED ENDS:

				Globe	Angle
MIL-V-22094	Comp D A105	150 LB		251311	251411
		300 LB		252311	252411
		600 LB		253311	253411
		1500 LB		259311	259411
		150 LB		261311	261411
	Comp B F11	300 LB		262311	262411
		600 LB		263311	263411
		1500 LB		269311	269411

DIMENSIONS: Flanged

SIZE		1/2	3/4	1	1 1/4	1 1/2	2
150 LB	FF	4 1/4	4 5/8	5	5 1/2	6 1/2	8
	D	3 1/2	3 7/8	4 1/4	4 5/8	5	6
	BC	2 3/8	2 3/4	3 1/8	3 1/2	3 7/8	4 3/4
	Holes	4	4	4	4	4	4
300 LB	FF	6	7	8	8 1/2	9	10 1/2
	D	3 3/4	4 5/8	4 7/8	5 1/4	6 1/8	6 1/2
	BC	2 5/8	3 1/4	3 1/2	3 7/8	4 1/2	5
	Holes	4	4	4	4	4	8
600 LB	FF	6 1/2	7 1/2	8 1/2	9	9 1/2	11 1/2
	D	3 3/4	4 5/8	4 7/8	5 1/4	6 1/8	6 1/2
	BC	2 5/8	3 1/4	3 1/2	3 7/8	4 1/2	5
	Holes	4	4	4	4	4	8
1500 LB	FF	8 1/2	9	10	11	12	14 1/2
	D	4 3/4	5 1/8	5 7/8	6 1/4	7	8 1/2
	BC	3 1/4	3 1/2	4	4 3/8	4 7/8	6 1/2
	Holes	4	4	4	4	4	8

W & O SUPPLY INC

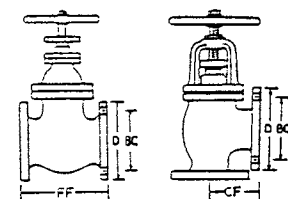
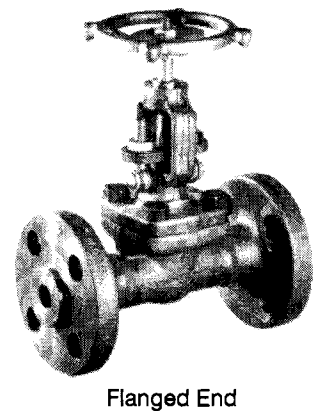
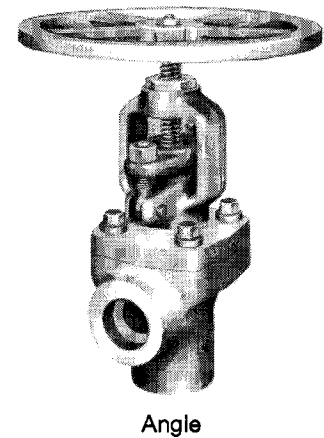
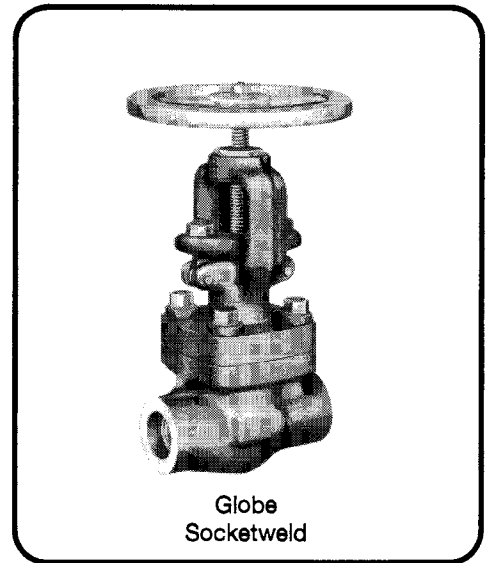

BOILER BLOWDOWN VALVE 600 - 1500 LB

MIL-V-17737, TYPE I & II, CLASS 2

SIZE: 1 1/2"

DESIGN DESCRIPTION

A105 Forged steel body and bonnet
Stellite trim
Bolted bonnet
Flanged ends
Type I - Handwheel
Type II - Removable T handle

600 LB	Y-Globe	298311
1500 LB	Y-Globe	299311
1500 LB	Angle	299411

DIMENSIONS FOR Y-GLOBE:

		600 LB	1500 LB
1 1/2	FF	7 1/2	15
	D	5	7
	BC	37/8	47/8
	Holes	4	4

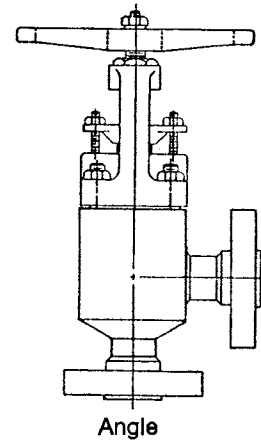
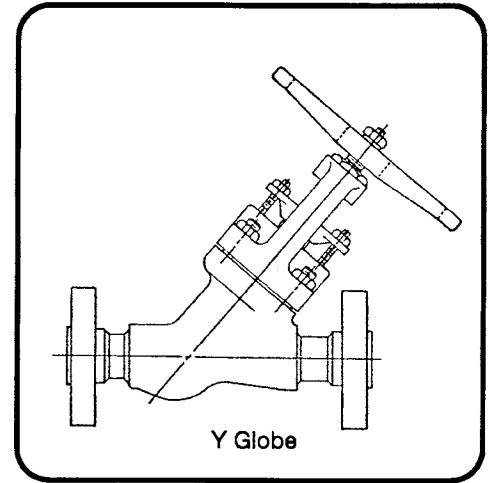

MONEL BOILER VALVE 600 / 1500 LB

MIL-V-17737, TYPES I through VIII

SIZE: 1 1/2"

DESIGN DESCRIPTION

Monel body, bonnet and trim
Bolted bonnet
Flanged ends
Stop check available

600 LB	Globe	293311
1500 LB	Globe	296311
600 LB	Angle	293411
1500 LB	Angle	296411

DIMENSIONS

		600 LB	1500 LB
1 1/2	FF	9 1/2	12
Globe	D	5	7
	BC	37/8	47/8
	Holes	4	4
1 1/2	FF	4 3/4	6
Angle	D	5	7
	BC	37/8	47/8
	Holes	4	4

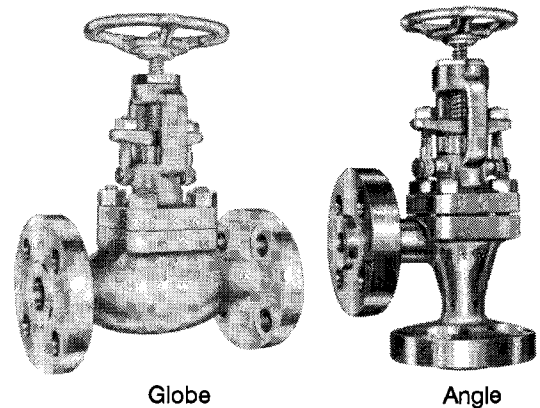

CAST STEEL GATE

150 LB - 300 LB NAVY

MIL-V-18110

DESIGN DESCRIPTION

Outside screw and yoke
Bolted bonnet
Flanged or buttweld ends

Cast carbon steel (WCB) body and bonnet with CR13/HF trim. Available all stainless steel. Outside screw and yoke; bolted bonnet construction.

Dimensions and drilling equal to commercial cast steel valve specifications: see pages 37, 39. Navy drilling on request.

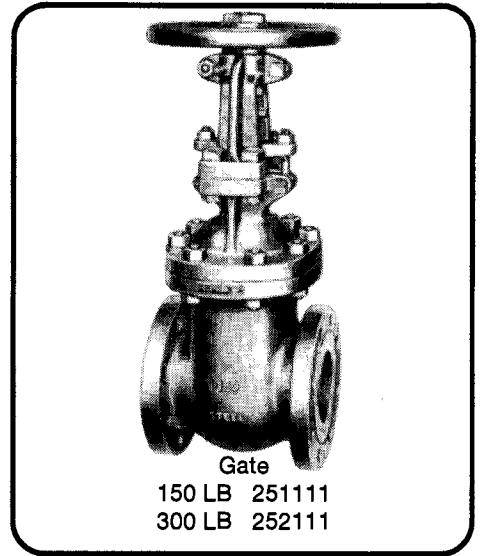

CAST STEEL GLOBE & ANGLE 150 LB - 300 LB

MIL-V-22052

DESIGN DESCRIPTION

Outside screw and yoke
Bolted bonnet
Flanged or buttweld ends
Available with stop check

Cast carbon steel (WCB) body and bonnet with CR13/HF trim. Available all stainless steel. Outside screw and yoke; bolted bonnet construction.

Dimensions and drilling equal to commercial cast steel valve specifications: see pages 40, 41. Navy drilling on request.

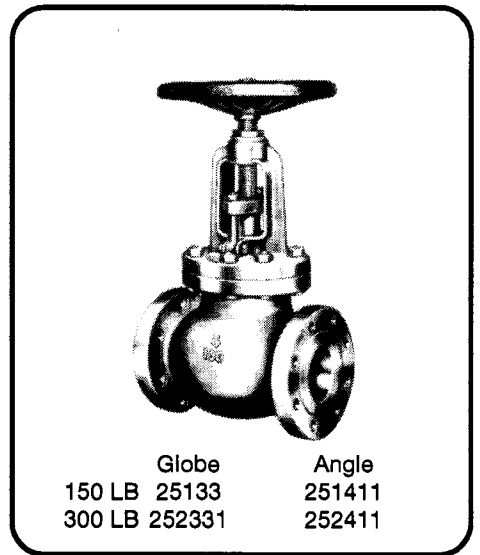

CAST STEEL SWING CHECK 150 LB NAVY

MIL-V-18436

DESIGN DESCRIPTION

Bolted bonnet
Flanged or buttweld ends

Cast carbon steel (WCB) body and cap with CR13/HF trim. Available in all stainless steel construction. Bolted cap.

Dimensions and drilling equal to commercial cast steel valve specifications: see pages 45, 47. Navy drilling on request.

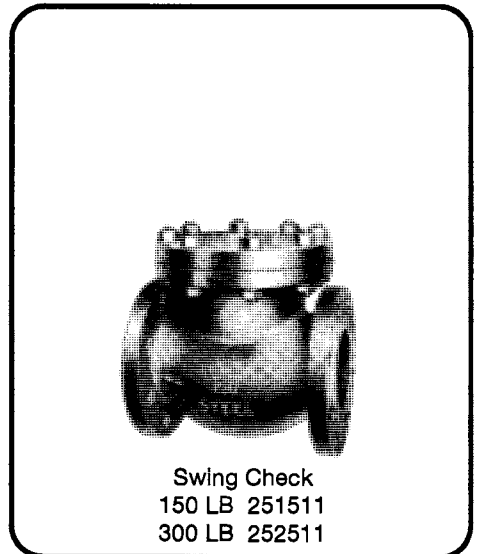

PRESSURE-SEAL GATE

600 - 900 - 1500 LB

MIL-V-18110

SIZES: 2" to 12"

DESIGN DESCRIPTION

BODY: Carbon steel - Cast WCB, Forged A-105
 or Chromemoly steel - Cast WC6, Forged F11
 also available in stainless steel
 buttweld or flanged ends

TRIM: HF Stellite

PART NUMBERS:

		Buttweld	Flanged
600 LB	A-105/WCB	273141	273111
	F11/WC6	283141	283111
900 LB	A-105/WCB	275141	275111
	F11/WC6	285141	285111
1500 LB	A-105/WCB	276141	276111
	F11/WC6	286141	286111

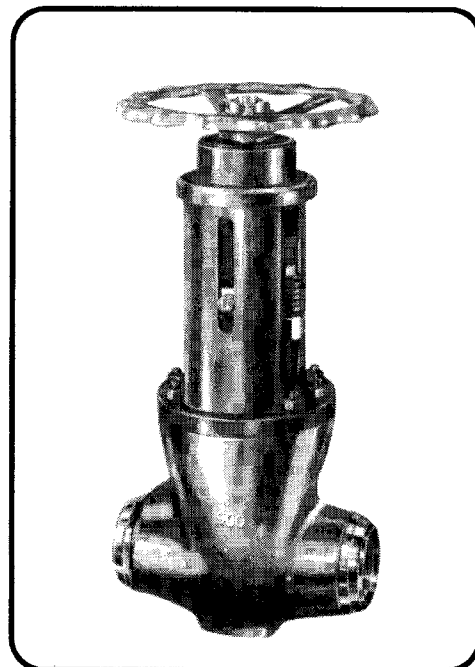

PRESSURE-SEAL

GLOBE AND ANGLE

600 - 900 - 1500 LB

MIL-V-22052

SIZES: 2" to 12"

DESIGN DESCRIPTION

BODY: Carbon steel - Cast WCB, Forged A-105
 or Chromemoly steel - Cast WC6, Forged F11
 also available in stainless steel
 buttweld or flanged ends

TRIM: HF Stellite

PART NUMBERS:

		Globe Buttweld	Globe Flanged	Angle Buttweld	Angle Flanged
600 LB	A-105/WCB	273341	273311	273441	273411
	F11/WC6	283341	283311	283441	283411
900 LB	A-105/WCB	275341	275311	275441	275411
	F11/WC6	285341	285311	285441	285411
1500LB	A-105/WCB	276341	276311	276441	276411
	F11/WC6	286341	286311	286441	286411

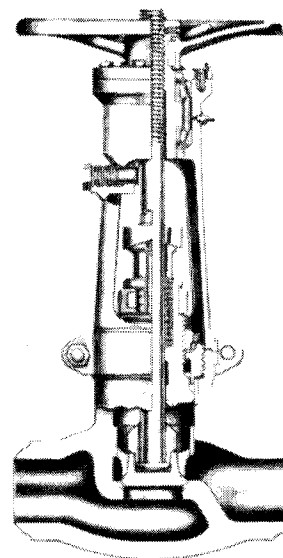

Globe Cutaway

BUTTERFLY VALVE

MIL-V-24624

SIZES: 2 1/2" to 24"

DESIGN DESCRIPTION

High performance type construction without typical butterfly resilient type seat allows for fire resistant high heat application.

Aluminum Bronze (Type III) or Stainless (Type I) body

Teflon seats with metal backup

Fire resistant

Available in wafer (Style A) or lug (Style B) styles

Gear Operator is standard

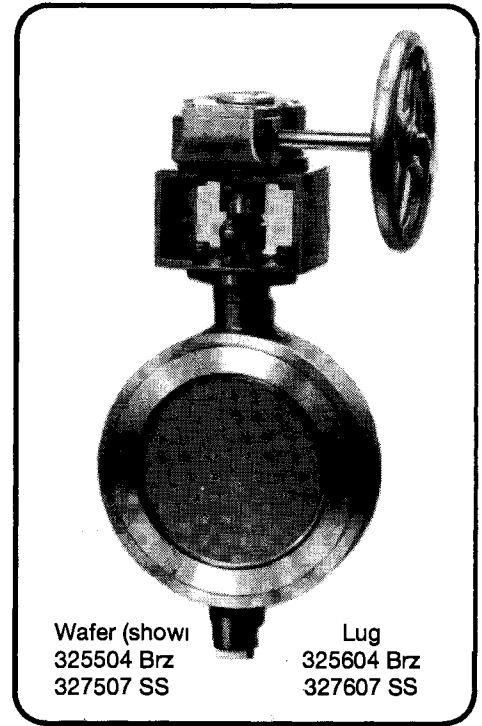

MIL-V-22133

SIZES: 1 1/2" to 18"

DESIGN DESCRIPTION

Nickel aluminum bronze body

Monel disc and stem

Rubber seats (Buna-N)

Available in wafer or lug styles

Lever or Gear Operated

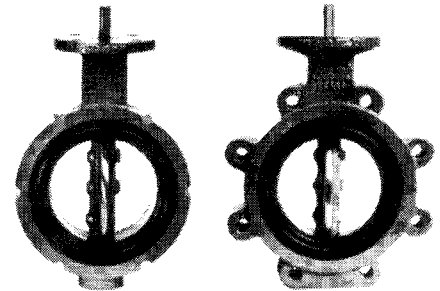

Wafer
325104

Lug
325204

VENTILATION BUTTERFLY

DWG 805-1749102 (ROUND)

DWG 805-1749103 (OVAL)

SIZES: 2 1/2" to 30"

DESIGN DESCRIPTION

Aluminum body and disc or all stainless (rev. C) construction

Rubber seat or fire safe seat

Round or oval wafer pattern

30 LB rated test pressure

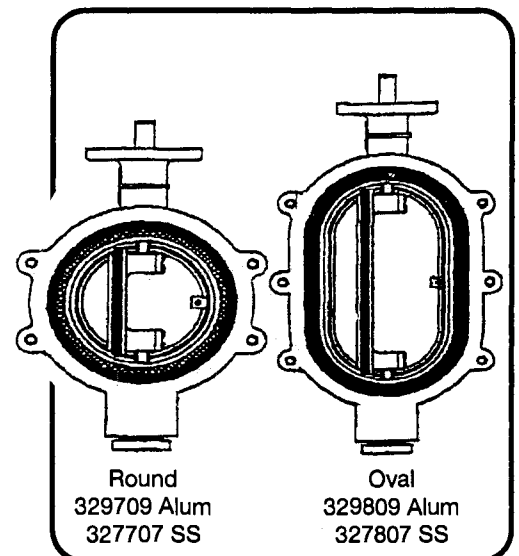
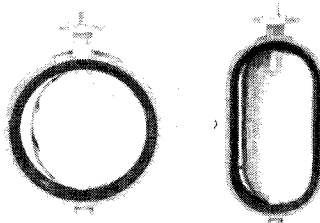

BRONZE PLUG VALVES

100 LB NAVY

MIL-V-24509

SIZES: 1 1/4" to 8"

DESIGN DESCRIPTION

Bronze body and plug
Lubricated design
Round full flow port
Navy flanged ends MIL-V-20042

Available in straightway or multiport patterns
"Way" refers to number of outlets on body
"Port" refers to number of outlets in plug
2 port also called "angle port". 3 port also called "tee port".

Common Flow Plan Configurations:

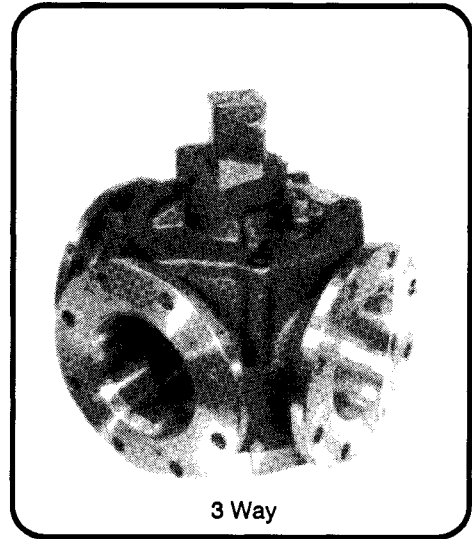

3 Way

- 365202 2 Way 2 Port
- 365302 3 Way 2 Port (Flow 10)
- 365353 3 Way 3 Port (Flow 5)
- 365373 3 Way 3 Port (Flow 7)

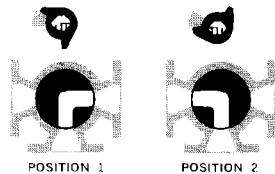

3 Way 2 Port
Flow 10

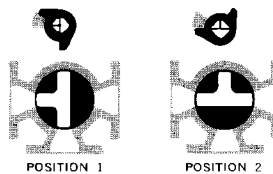

3 Way 3 Port
Flow 5

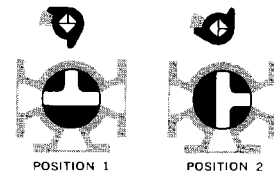

3 Way 3 Port
Flow 7

Other Flow Plan Configurations: 3 Way 3 Port

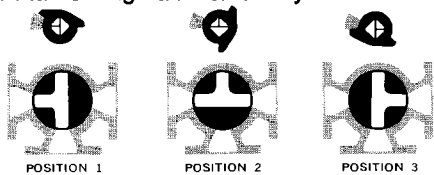

Flow 1

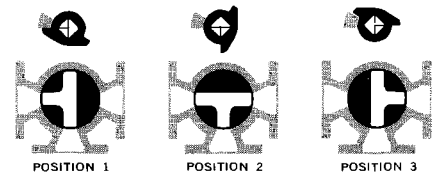

Flow 2

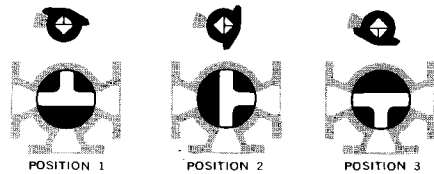

Flow 3

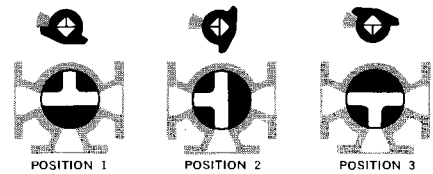

Flow 4

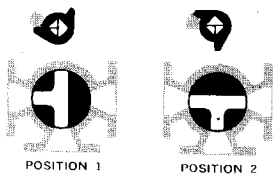

Flow 6

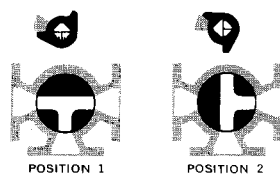

Flow 8

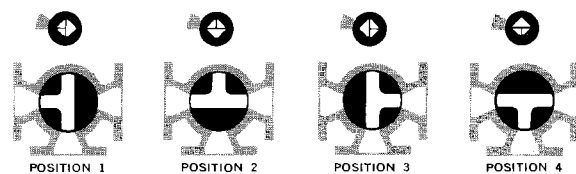

Flow 9

NAVY BALL VALVES

MIL-V-24509

FLANGED 150 WOG

SIZES: 1 1/4" to 6"

DESIGN DESCRIPTION

Bronze body and ball
 Monel stem, teflon seat
 Flanged ends MIL-V-20042
 Available in 2-way and 3-way patterns

SIZE	1 1/4	1 1/2	2	2 1/2	3	4	5	6
FF	5 1/4	5 3/4	6 1/2	7 3/4	9	10 1/2	13	15
D	4 1/2	5 1/16	5 9/16	6 1/8	6 5/8	7 11/16	9 1/16	10 1/8
BC	3 3/8	3 15/16	4 7/16	5	5 1/2	6 9/16	7 13/16	8 7/8
Holes	4	6	6	6	8	8	10	12

DWG 5001003 1/4" to 2 1/2" 700 PSI
 5001004 3" to 6" 700 PSI

BODY: Bronze, CopperNickel, Steel or Stainless
 BALL: Titanium or CRES/SS
 SEATS: Teflon
 ENDS: Silbraze, Socketweld, Buttweld, Hose or Flanged
 available in 2-way and 3-way patterns

UNION END SILBRAZE 400 PSI

SIZES: 1/4" to 2"

Bronze body
 Silbraze ends bronze
 Steel union nuts
 Bronze or monel ball
 Teflon seats

HIGH PRESSURE MIL-V-22687 3000-4500 PSI

SIZES: 1/4" to 2"

BODY: Bronze, Coppernickel or Stainless
 ENDS: Silbraze or Socket weld
 STYLE: Direct braze/weld or Union End
 SEATS: Teflon

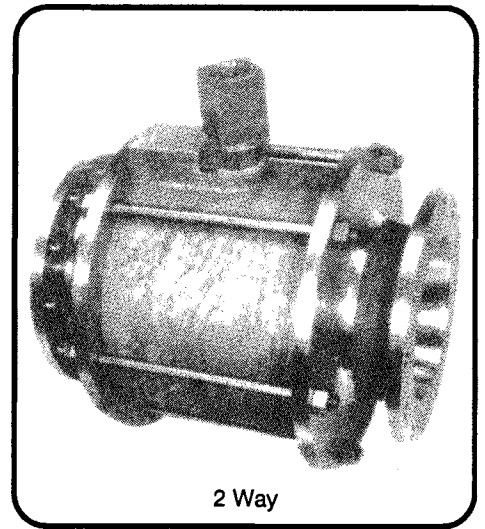

2 Way

- 359202 2 Way Straight
- 395302 3 Way 2 Port
- 395302 3 Way 3 Port(Flow 5)
- 395373 3 Way 3 Port (Flow 7)

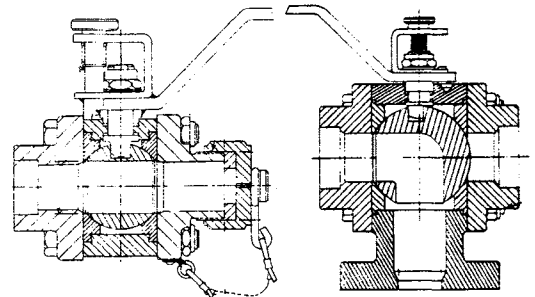

- 393305 2 Way Silbraze (1/4"-2 1/2")
- 393305 2 Way Silbraze (3" - 6")
- 393355 2 Way Silbraze x Hose
- 393905 3 Way Silbraze x Flanged

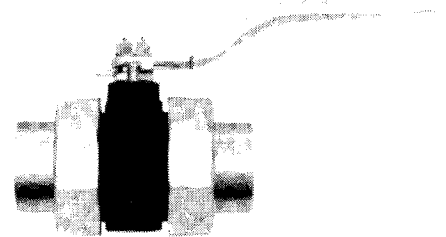

375502 Union End Silbraze

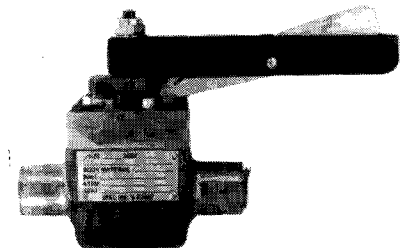

395901 MIL-V-22687

RELIEF VALVES

MIL-V-22549 AIR OR GAS SERVICE

MIL-V-24332 LIQUID SERVICE

MIL-V-20065* STEAM SERVICE

* some old MIL-V-20065 valves may be air or liquid service

SIZES: 1/4" to 8"

DESIGN DESCRIPTION

Bronze, steel, alloy steel or stainless steel

Monel or stainless steel trim

Stellite or hard-faced trim available for severe applications

Plated steel, hi-temp steel, phosphor bronze, stainless steel, or monel
springs available depending on size and pressure

CONNECTIONS

Union end silbraze - Bronze

Flanged commercial - Bronze or steel

Flanged Navy - Bronze or steel

Flanged x silbraze - Bronze

SPECIFY:

Material

End connections - inlet and outlet

Spring set pressure to relieve at

Enclosed or exposed spring

With or without lift lever

Service: liquid, air, or steam



Union End Silbraze
505101

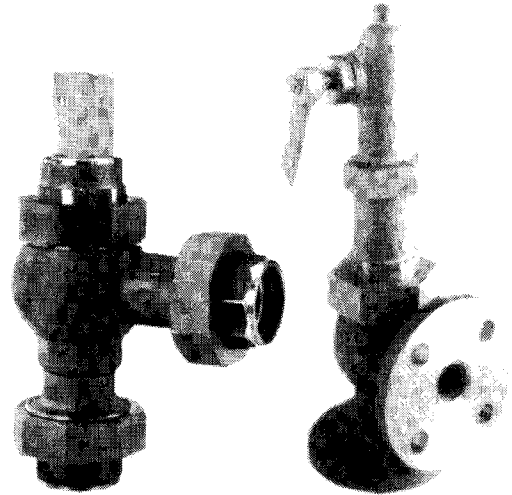

Union End
Without Lift Lever
Air Service Only
505100

Flanged
Bronze - 505102
Steel - 505202

IN LINE CHECK VALVE

SIZES: 1/4" to 2" IPS

DESIGN DESCRIPTION

Stainless steel, brass or steel body

Silbraze or socketweld union ends

One-way check mechanism for high pressure service in air, water and hydraulic application.

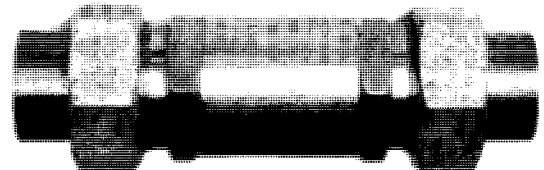

583900

STRAINERS NAVY

MIL-S-2953 FLANGED, BUTTWELD or SOCKETWELD
 MIL-S-16293 FLANGED or THREADED
 DWG 841499 SILBRAZE

Y-TYPE

SIZES: 1/4" to 12"

DESIGN DESCRIPTION

Bronze, Iron, Steel or Stainless body
 Stainless or Monel perforated screen

Ends: Silbraze	Fig 690101 (Bronze)
Threaded	Fig 690102 (Bronze), 690301 (Steel)
Socketweld	Fig 690302 (Steel)
Flanged	Fig 690401 (150 Navy Bronze)
	Fig 690402 (250 Navy Bronze)
	Fig 690404 (400 Navy Bronze)
	Fig 690504 (150 ANSI Bronze)

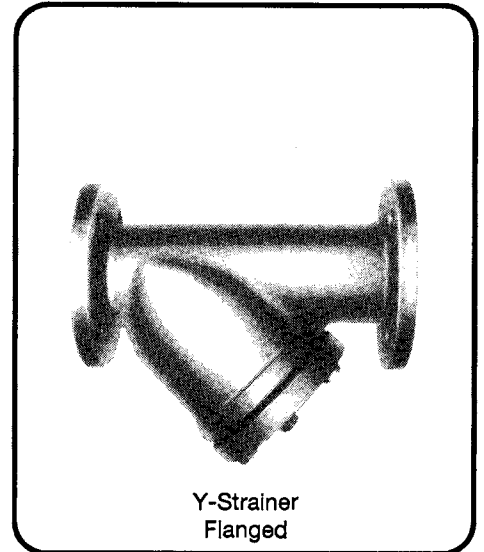

Y-Strainer
Flanged

MIL-S- 16293 FLANGED or THREADED

SIMPLEX

SIZES: 1/2" to 12"

DESIGN DESCRIPTION

Bronze, Steel or Stainless body
 Stainless or Monel perforated screen

Flanged Ends:	Fig 691401 (Bronze 150 Navy)
	Fig 691402 (Bronze 250 Navy)
	Fig 691501 (Bronze 150 ANSI)
	Fig 691601 (Steel 150 ANSI)
	Fig 690500 (Bronze Offset "Macomb" Type)

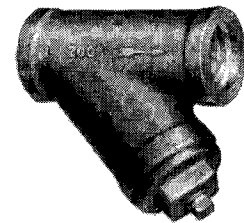

Y-Strainer
Silbraze

MIL-S-17849 Bronze & Steel
 DWG 5001048 Steel 600 LB

DUPLEX

SIZES: 1" to 8"

DESIGN DESCRIPTION

Stainless or Monel perforated screen
 Available with Navy MIL-F-20042 or commercial ANSI flanges

Flanged Ends:	Fig 692401 (Bronze 150 Navy)
	Fig 692402 (Bronze 250 Navy)
	Fig 692501 (Bronze 150 ANSI)
	Fig 693606 (Steel 600 ANSI)

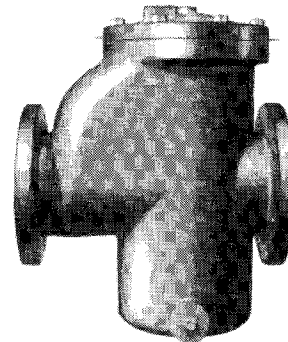

Simplex
Strainer

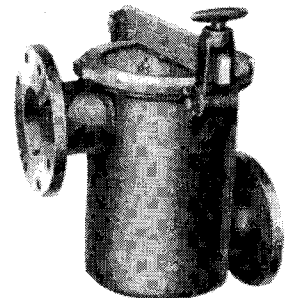

Offset
"Macomb"
Simplex
Strainer

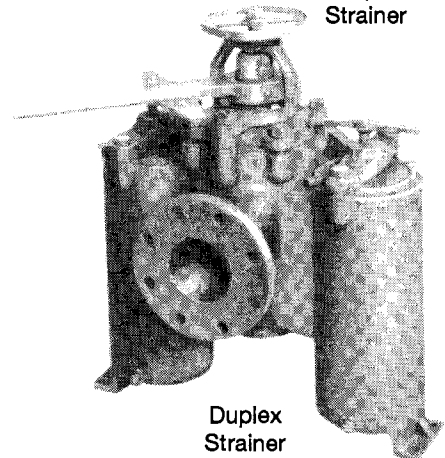

Duplex
Strainer

NAVY PRESSURE REDUCING VALVES

MIL-V-2042 LIQUID REDUCER

SIZES: 1/4" to 6"

Bronze construction with monel trim
Buna rubber diaphragms, gaskets and O-rings
Silbrazed union ends (Fig 502101) or
Navy flanged 150 (Fig 502102) or 250 (Fig 502103)

Designed to provide accurate regulation of salt or sea water systems. Compact, single-seat design eliminates the effect of variable inlet pressures. May be installed in any position. Completely self-contained unit requires no external sensing lines or control medium.

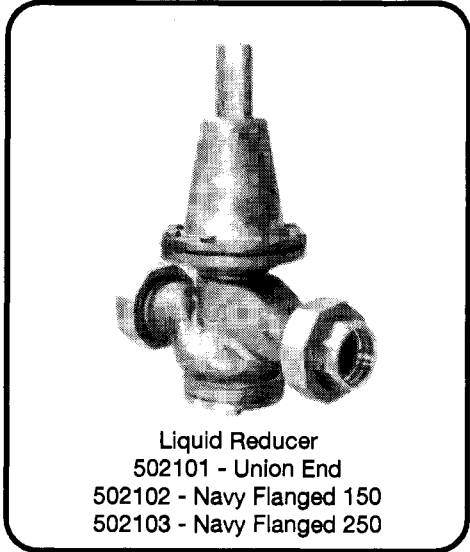

Liquid Reducer
502101 - Union End
502102 - Navy Flanged 150
502103 - Navy Flanged 250

MIL-V-2961 TYPE 1 AIR REDUCER MIL-V-24384 TYPE 1 AIR REDUCER

SIZES: 1/4" to 2"

Bronze construction with monel trim
Buna rubber diaphragms, gaskets and O-rings
Silbrazed union ends (Fig 502201)

Designed to provide accurate regulation of low pressure air or nitrogen systems. Compact, single seat design eliminates the effect of variable inlet pressures. May be installed in any position. Completely self-contained unit requires no external sensing lines or control medium.



Air Reducer
502201

MIL-V-24384 TYPE III AIR REDUCER PRIORITY VALVE

SIZES: 1 1/4", 1 1/2", 2"

Bronze construction with monel trim
Buna rubber diaphragms, gaskets and O-rings
Silbrazed union ends (Fig 502202)

Specifically designed for back pressure regulation applications and intended for installation in low pressure (150 PSIG or below) air or nitrogen systems. Used to protect the supply of pressure to essential or "priority" services by throttling down or cutting off the flow to all non-essential services when necessary. The valve senses upstream pressure and acts to throttle down or completely shut off the flow at any time the sensed pressure drops below a safe level.

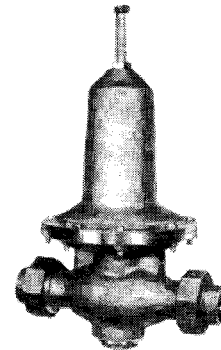

Priority Valve
502202

MIL-V-2961 TYPE II AIR REDUCER DOME LOADED REDUCER

SIZES 1/4" to 2"

Bronze construction with monel trim
Buna rubber diaphragms, gaskets and O-rings
Silbrazed union ends (Fig 502501)
High pressure 600 LB, 3000 LB, and 6000 LB

Used on ships high pressure air or nitrogen system, these self-contained regulators utilize a dome of air or nitrogen, bled from the high pressure side and locked into a sealed chamber, to control the downstream pressure.

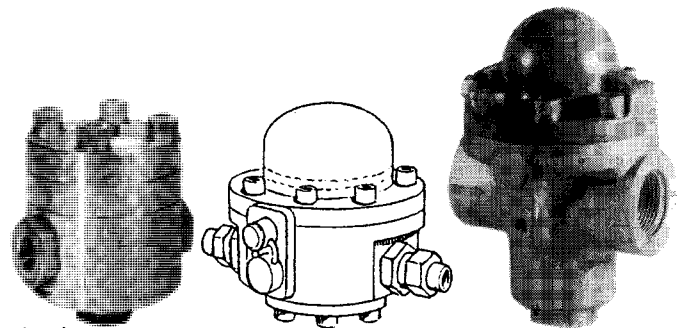

Dome Regulator - 3 Styles 502501

MISC. NAVY REGULATORS

MIL-R-16743

SIZES: 1/2" to 4"

Penn, Johnson, Marsh, Metrex types

Water regulator used for refrigeration systems. Specify coolant.
Bronze body
Flanged or threaded ends

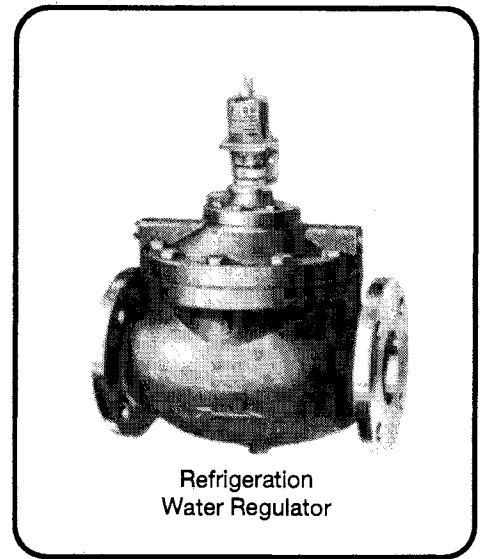

Refrigeration
Water Regulator

MIL-V-17992 TYPE I

SIZES: 2" to 6"

Amot type

3 Way thermostatic valve
Bronze body
Flanged ends

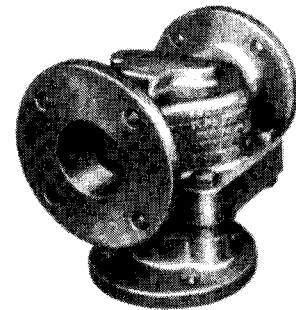

Robertshaw type

3 Way thermostatic valve
Bronze body
Flanged ends

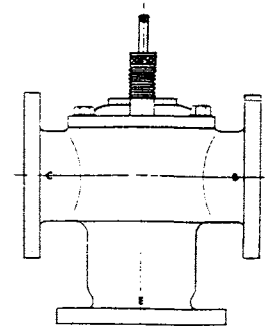

MIL-V-20065A

SIZES: 1/2" to 2"

Trac type

Back pressure regulator for liquids
Bronze body
Flanged ends to MIL-V-20042

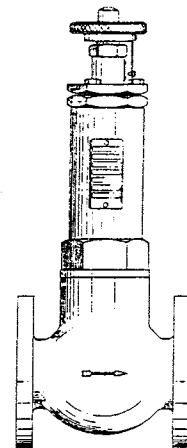

STEAM PRESSURE REDUCING VALVE

MIL-V-17848

SIZES: 1/2" to 4"

DESIGN DESCRIPTION

Provides accurate regulation comparable to instrument control. Sensitive stainless steel diaphragm responds instantly to flow changes, eliminating the need for stuffing boxes and bellows seals. Reduced pressure range is adjustable. Fully guided main valve prevents rubbing or binding of internal parts.

Single-seated for positive shut-off
Cast steel or bronze body
Stainless steel internals
150 LB, 300 LB, 600 LB Flanged ends: 1/2" to 4"
600 LB Threaded ends: 1/2" to 2"

STEAM PRESSURE CONTROL VALVE

MIL-V-18030

SIZES: 1/2" to 12"

DESIGN DESCRIPTION

Diaphragm type control valve
Cast steel or bronze body
150 LB, 300 LB, 600 LB Flanged ends
Straight or angle pattern
Single or double seated
Pressure and temperature pilot controllers available

PUMP PRESSURE REGULATOR

MIL-G-18916

SIZES: 1/2" to 21/2"

DESIGN DESCRIPTION

Cast steel body
Flanged ends

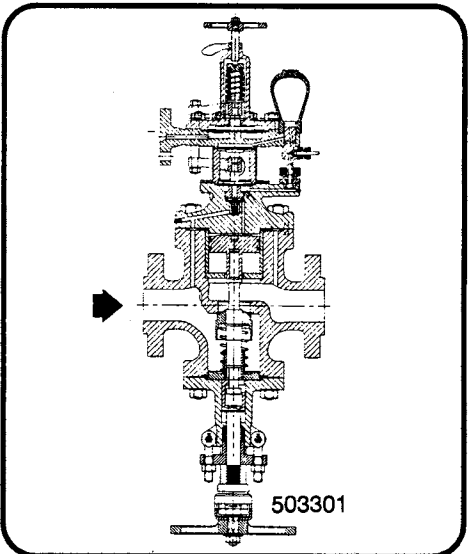
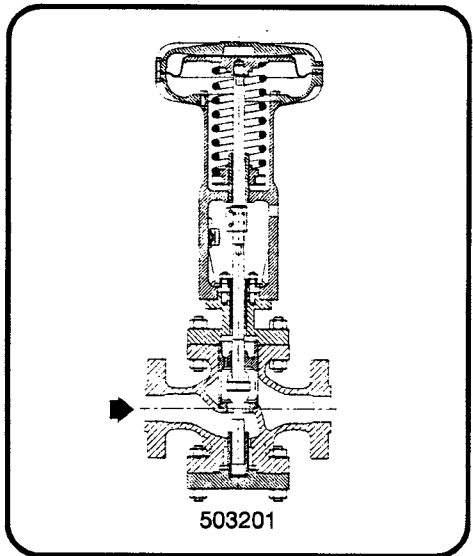
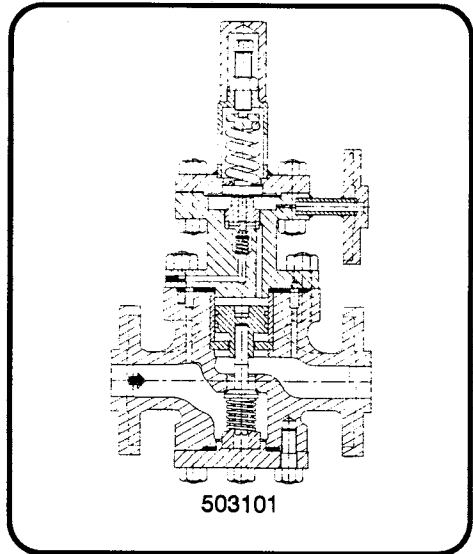

TEMPERATURE REGULATING VALVE

MIL-V-19772, TYPE I and II - Thermostatic Temp Regulator
 TYPE IV - Combination Temp/Press Regulator

SIZES: 1/2" to 2"

DESIGN DESCRIPTION

Bronze body
 Union end silbrazed or flanged ends
 2 Way or 3 Way

Specify : temperature range
 capillary length
 thermocoupler length
 direct or reverse acting

Three basic types: please specify:

2 Way direct acting - rise in temperature closes valve
 2 Way reverse acting - rise in temperature opens valve
 3 Way - application in mixing or diverting service

MIL-V-3155 for Steam Control of Ventilation Heaters

SIZES: 1/2" to 1 1/2"

DESIGN DESCRIPTION

Bronze body
 Union end silbrazed

Specify : temperature range
 capillary length
 thermocoupler length
 direct or reverse acting

Three models:

- E - Single thermostat
 Sizes 1/2" - 1 1/2"
- G - Single thermostat
 Size 1 1/2" high capacity
- D - Double thermostat
 Sizes 3/4" - 1 1/2"

Thermostat Types:

- W - Weather type - non adjustable with 10' capillary
- L - Duct type - adjustable range 40-100° F with 10' capillary
- R - Room type - adjustable range 60-80° F with 25' capillary

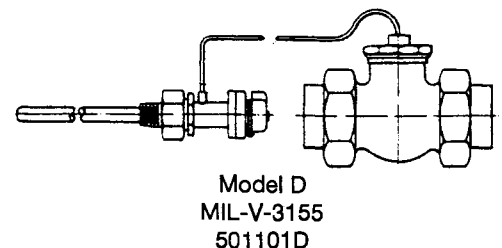
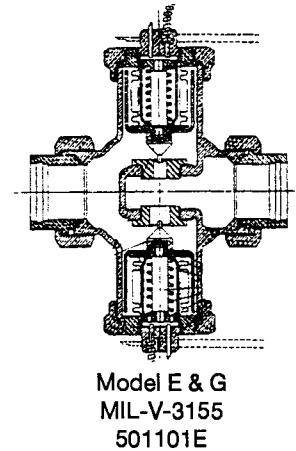
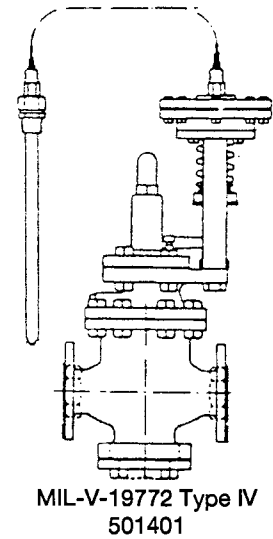
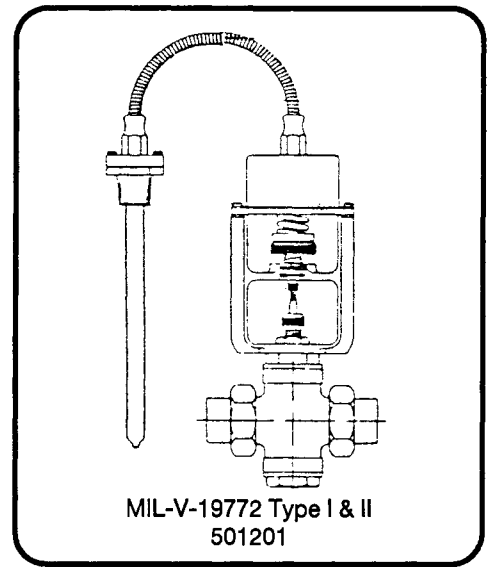

MAGAZINE SPRINKLER VALVE

MIL-V-15508
 MIL-V-17501, TYPE 1
 MIL-V-17547, TYPE B, CLASS 2

DESIGN DESCRIPTION

Automatic diaphragm-actuated, hydraulically (or pneumatically) operated valves utilizing hydraulic or air pressure from any available source, such as fire mains or compressed air systems.

MIL-V-17501 - MAGAZINE SPRINKLER CONTROL VALVE

Powertrol type is ideally suited to an extreme range of operating requirements. It contains a separate operating chamber under the diaphragm and is designed to open when controlling pressure is applied under the diaphragm. When controlling pressure is released, the valve closes. The powertrol valve is normally supplied with hose thread provision for test fitting. Sizes 1" to 8", union end silbrazed or Navy flanged.

MIL-V-15508 - FOG FOAM CONTROL VALVE

Hytrol type is used in piping systems requiring remote control, pressure regulation, solenoid operation, rate of flow control, liquid level control, or check valve operation. Operation results from application or release of pressure in a chamber above the diaphragm. Sizes 3/8" to 8", union end silbrazed or Navy flanged.

MIL-V-17547 - TYPE B CLASS 2 LIFT CHECK VALVE

Lift check valve constructed of bronze with monel trim and is supplied with 100LB or 250 LB Navy flanged ends in sizes 2" to 8".

CONTROLS AND ACCESSORIES FOR MAGAZINE SPRINKLER SYSTEM

Three way manual diverter valve is supplied with 3/8" silbrazed union ends.

Dual solenoid valve control is bronze with 3/8" silbrazed union ends.

Diaphragm check - spring loaded diaphragm operated lift check.

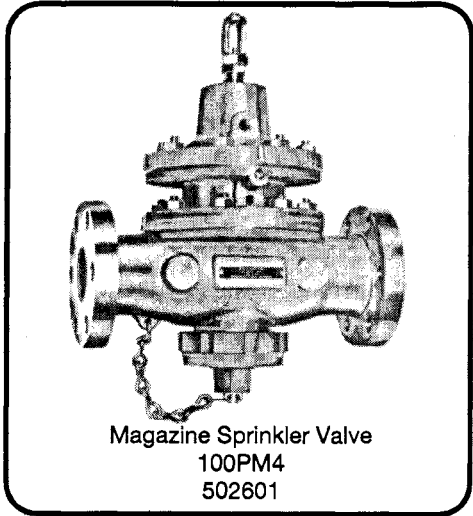

Magazine Sprinkler Valve
 100PM4
 502601

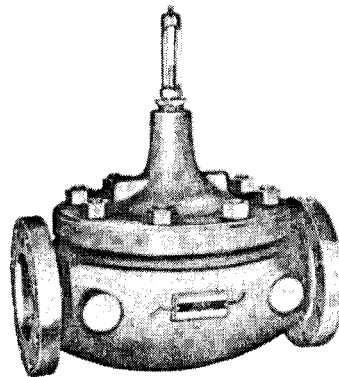

Fog Foam Valve
 100M-1
 502701

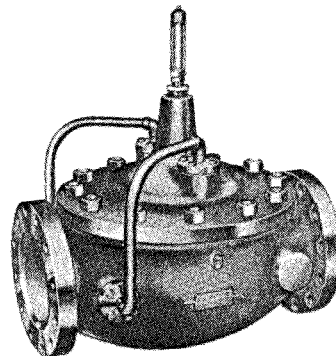

Lift Check Valve
 81M-3
 502801



Solenoid Valve
 CSM5M
 502605

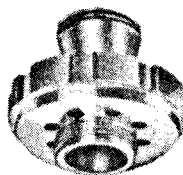

Test Fitting
 502609

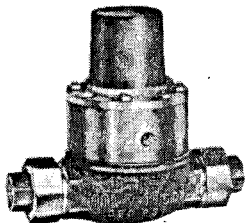

Hydraulic Check
 81PM
 502802

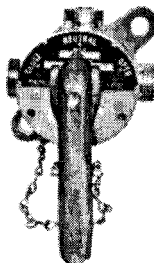

Threeway Manual Diverter
 CM15M
 502603



Diaphragm Check
 81M
 502602

MARINE STRAINERS

DWG 1385901: 1 1/2"
DWG 461052: 2 1/2"

DESIGN DESCRIPTION

Protects hose lines and nozzles from foreign matter
Supplied with blow-off valve to clean screen
Bronze body
Coppernickel screen

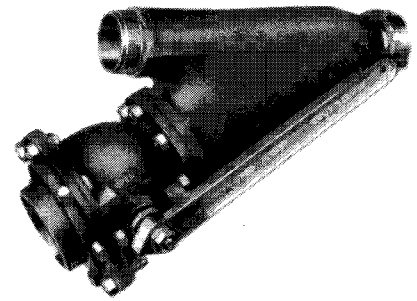

Marine Strainer
694101

FLOATING BALL CHECK

DWG 5959276

SIZE: 1 1/2"

Steel body
Threaded ends

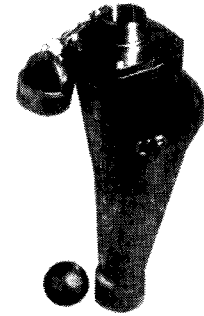

Floating Ball Check
502901

DRAIN STRAINER ORIFICE

DWG 5001057

SIZES: 1/2" and 3/4"

Stainless Body
Socketweld Ends
900 LB Rated

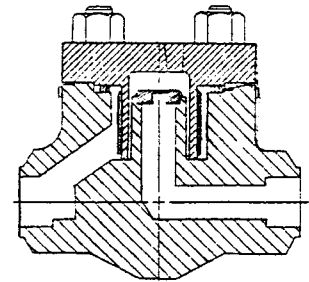

Drain Strainer Orifice
235931

SPRINKLER HEAD

MIL-H-1149

SIZES: 3/8" to 3/4"

Bronze, Stainless or Monel
Threaded or Male Silbrazo Connection

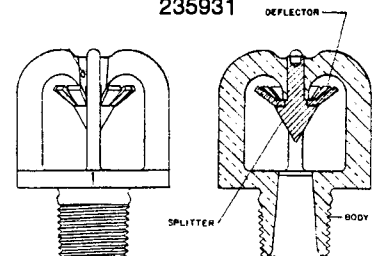

Sprinkler Head
513501

P-TRAP AND S-TRAP

SIZES: 1 1/4", 1 1/2", 2"

Bronze Construction
Threaded, Slip, Silbrazo, or Union Ends

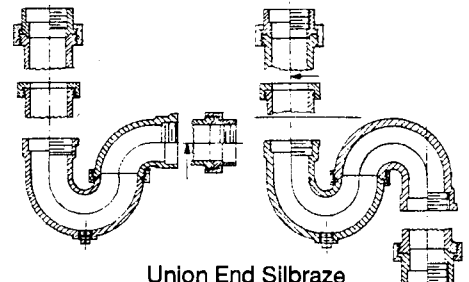

Union End Silbrazo
P-Trap - 512101
S-Trap - 512102

STEAM TRAPS

MIL-T-2118

SIZES: 1/2" to 1 1/2"

DESIGN DESCRIPTION

Bronze body
Silbrazed union end

Straight or angle type

Combination trap and check valve. This combination trap is available with or without integral strainer.

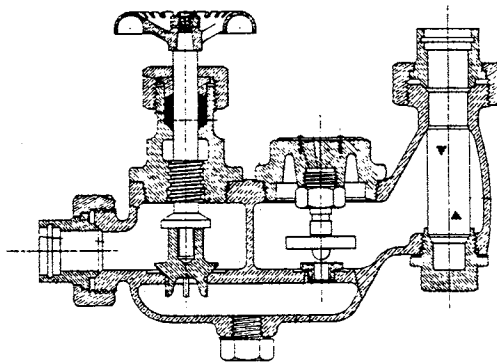
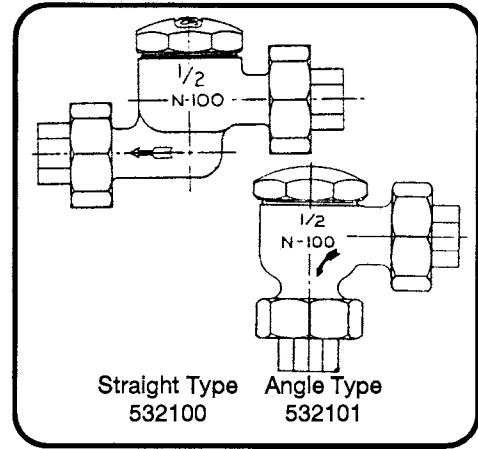

Combination Trap & Check & Strainer
532103

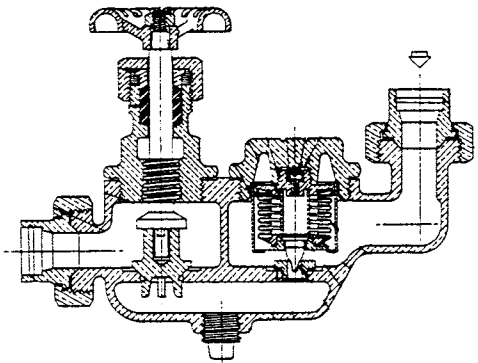

Combination Trap & Check
532102

MIL-T-960 TYPE II

SIZES 1/2" to 1"

DESIGN DESCRIPTION

Steel or chromemoly body
For high pressure and/or high temperature
Socketweld or flanged ends

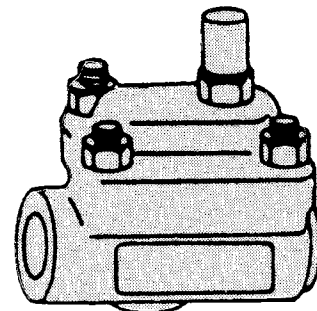

High Pressure
Steam Trap
Carbon Steel - 532201
Chromemoly - 532202

MIL-T-960 TYPE III

SIZES: 1/2" to 1"

DESIGN DESCRIPTION

Chevalier drainator®
Bronze body
Silbrazed union end

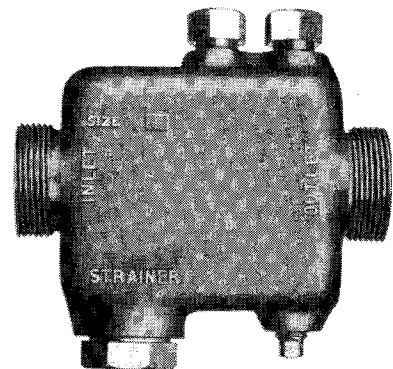

Chevalier Drainator®
532104

GAGE VALVES

6000 PSI

MIL-V-24578

SIZE: 1/4" OD

DESIGN DESCRIPTION

Stainless steel or monel body
Union end socketweld or bite-type compression ends.
Also available with male or female threaded ends .
Straight or angle pattern

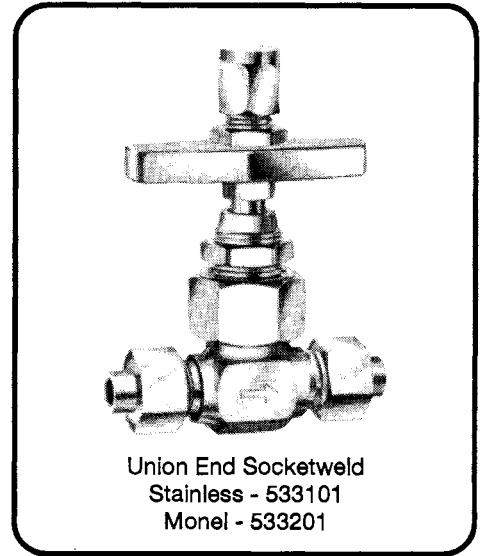

Union End Socketweld
Stainless - 533101
Monel - 533201

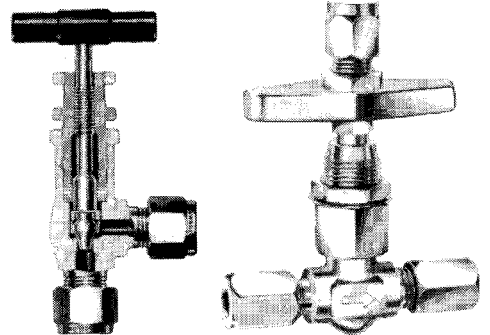

Angle Type
Stainless - 533401

Bite Type
Stainless - 533102
Monel - 533202

NEEDLE VALVES

5000 PSI

MIL-V-24586

SIZES: 1/4" to 1/2" IPS

DESIGN DESCRIPTION

Carbon or stainless steel body
Designed for use with IPS sized pipe
Socketweld ends
Union bonnet

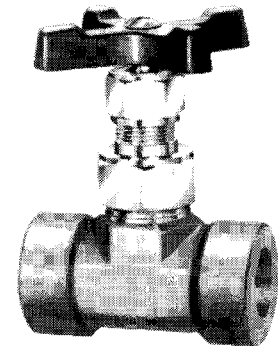

Steel 533401
Stainless 533407

LIQUID GAUGE VALVES

MIL-I-20031

SIZE: 3/4"

Flanged End

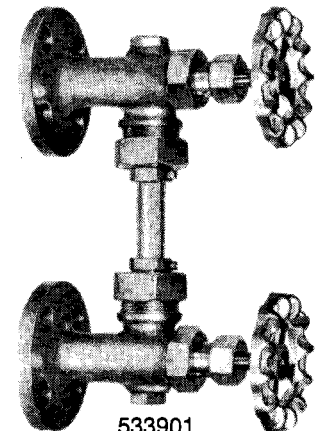

533901

DECK DRAINS

DWG 1385789

SIZES: 1 1/2" to 3"

TYPE A & TYPE D

Cast bronze with integrally-cast steel sleeve for direct welding to deck, eliminating the need for silbrazing. Furnished with trap and bell baffle, to seal pipe odors, and with Navy standard flush strainer. Outlet furnished for silver solder connection. Type A has manual valve for positive back flow protection. Type D has plain cover with no manual closing valve.

Also available in aluminum or coppernickel. Special design with flange for wood hull mounting is available.

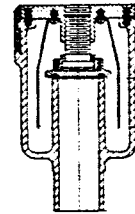

TYPE A
Bronze - 511101
Alum - 510101
70/30 - 510001

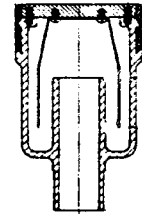

TYPE D
Bronze - 511104
Alum - 510104
70/30 - 510004

TYPE B

Cast bronze with integrally-cast steel sleeve for direct welding to deck, eliminating the need for silbrazing. Furnished with manual valve for positive back flow protection, bell baffle, and with Navy standard flush strainer. Outlet furnished for silver solder connection.

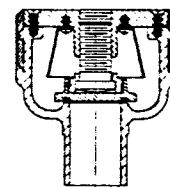

TYPE B
Bronze - 511102
Alum - 510102

TYPE C

Cast bronze with integrally-cast steel sleeve for direct welding to deck, eliminating the need for silbrazing. Plain deck or shower drain furnished with Navy standard flush strainer. Outlet furnished for silver solder connection.

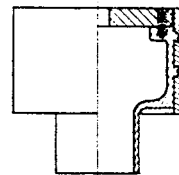

TYPE C
Bronze - 511103
Alum - 510103
70/30 - 510003

Also available in aluminum or coppernickel.

TYPE F

Cast aluminum for direct welding to aluminum deck. Plain deck or shower drain furnished with Navy standard flush strainer. Outlet flange drilled per MIL-F-20042.

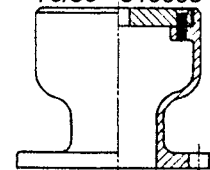

TYPE F
Aluminum - 511106

TYPE G & TYPE H

Cast bronze with integrally-cast steel sleeve for direct welding to deck, eliminating the need for silbrazing. Furnished with trap and bell baffle, to seal pipe odors, and with Navy standard flush strainer. Outlet furnished for silver solder connection with a pipe plug cleanout. Type G has manual valve for positive back flow protection. Type H has plain cover with no manual closing valve.

Also available in aluminum or coppernickel.

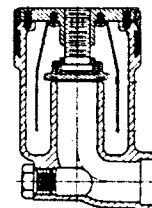

TYPE G
Bronze - 511107
Alum - 510107
70/30 - 510007

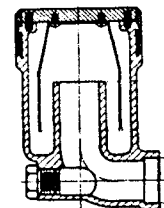

TYPE H
Bronze - 511108
Alum - 510108
70/30 - 510008

DECK ACCESS BOXES AND SOUNDING TUBES

DECK BOX
DWG 1385548

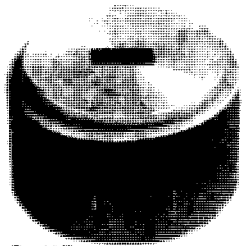

SIZES: 1 1/2", 2", 2 1/2"

Steel body
Bronze plug with rectangular countersunk hole
Slipon socket connection

DECK BOX

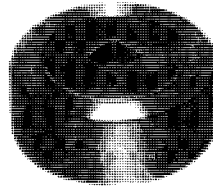

SIZES: 1 1/2", 2", 2 1/2"

Stainless body
Bronze plug with square hole
Socketweld connection

SOUNDING
TUBE
DWG 1385791
DWG 3285831
SIZE: 1 1/2"

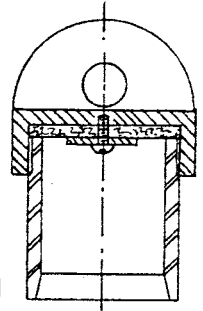

Steel body
Bronze cap
Plain pipe end connection

QUICK DISCONNECT FLANGE & FITTINGS

DWG 4444650, 2145526 (Flange Adapter)

SIZES: 1 1/2" to 6"

Bronze, Coppernickel, or Stainless, Aluminum

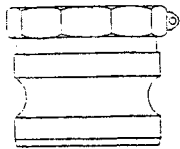

Part A
Male Connector
with Female Thread

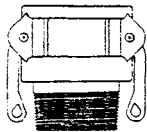

Part B
Female Connector
with Male Thread

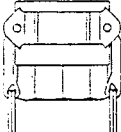

Part D
Female Connector
with Female Thread



Part F
Male Connector
with Male Thread

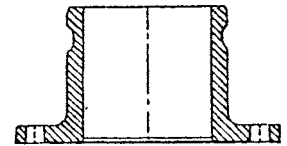

Flange Adapter

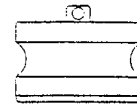

Dust Plug
Male Connector

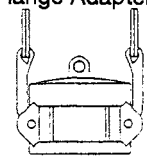

Dust Cap
Female Connector

THERMO FITTINGS

DWG 3285846

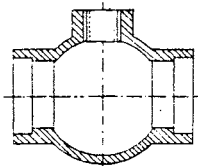

Thermo Tee
Globe Type A
Bronze Silbraz
513101-A

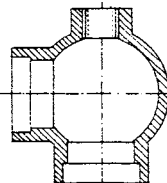

Thermo Tee
Angle Type B
Bronze Silbraz
513101-B



Thermowell
MIL-T-24270
Bronze 513103
Coppernickel 513104
Stainless 513105

VENT & DRAIN FITTINGS

DWG 1889868

SIZES: 1/4" to 2 1/2"

Bronze or 70/30 Coppernickel Construction
Silbraz Ends

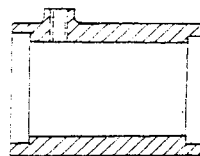

V&D Straight
513301

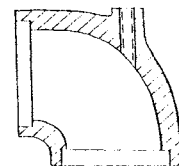

V&D Ell
513302

MEASURFLO®

SIZES: 1/4" to 1 1/2"

DESIGN DESCRIPTION

Automatic flow control / balancing valve for shipboard chilled water and air conditioning systems.

Material specification: QQ-C-390A Bronze
Union end silbraze per MIL-F-1183

Specify size and required GPM.

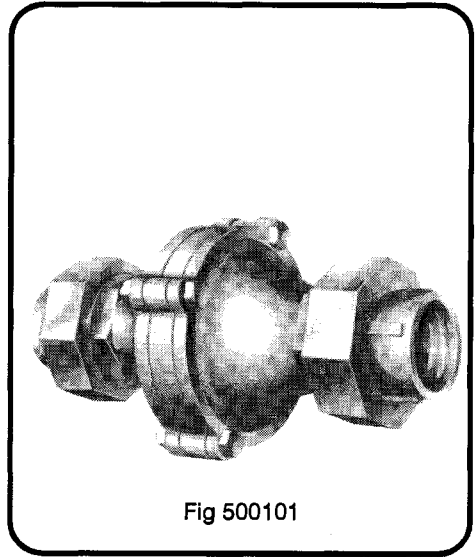

EDUCTORS

MIL-E-24127

DESIGN DESCRIPTION

Self-priming liquid jet pumps which utilize liquids and liquid/solid mixtures under pressure to create pumping action. In standard eductors the inlet pressure liquid discharges through a single nozzle to start pumping. There are no moving parts to break down or wear out. Available with flanged or threaded connections, for portable use or permanent installation. Used to pump liquids from chain lockers, bilges, cargo holds, tanks, or other similar spaces.

A peripheral jet type eductor utilizes straight-through, unrestricted flow allowing passage of larger suspended solids. Inlet pressure liquid is discharged through a multi-jet nozzle which permits handling of larger volumes of air. Suitable for pumping bilges, stripping ballast, or priming large pumps. Cannot lose suction: every gallon of inlet liquid (sea water) can pump up to 1 1/2 gallons of suction liquid (bilge water). Diagrams shown on page 75.

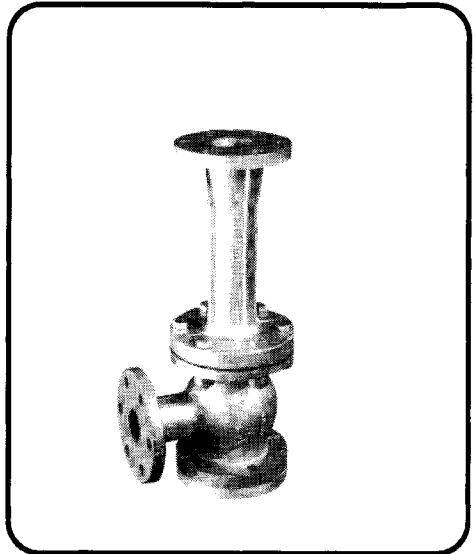

FLUSH VALVES

MIL-V-15020

Quiet dolphin exposed flushed valve, chrome plated with screw driver angle stop for urinal and closet flush applications. Rigid type use brazed connections. Shockproof have scored connections for rubber hose and clamp connections. Repair kits and parts available. See page 87.

CLOSET TYPE - 1" Inlet

Type I Class A - Shockproof
Type I Class B - Rigid

Fig 3057004
Fig 3057006

URINAL TYPE - 1/2" Inlet

Type II Class A - Shockproof
Type II Class B - Rigid

Fig 3057051
Fig 3057052

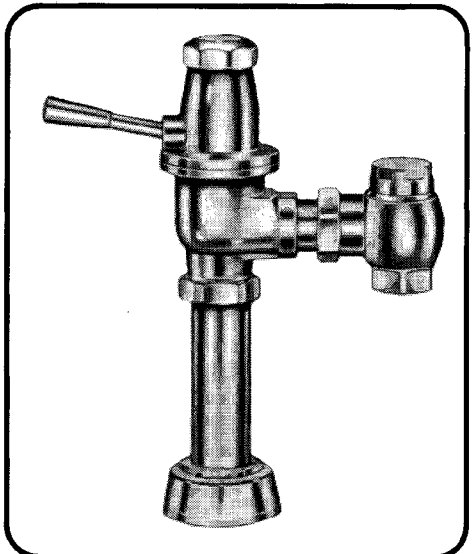

SCUPPER VALVES

SIZES: 2" to 8"

Bronze or Steel construction
With or without gag control

180° FLANGED COMMERCIAL (ANSI) or NAVY (MIL-F-20042)

Figure numbers	With Gag	No Gag
Outlet and Inlet same size	515071 Bronze	515070 Bronze
" " "	516071 Steel	516070 Steel
Outlet larger than Inlet (Comm)	515051 Bronze	515050 Bronze
" " "	516051 Steel	516050 Steel
Outlet special Navy, Inlet Std Navy	515111 Bronze	515110 Bronze
MIL-F-20042 DWGS 3285821(2")		
3285820(3"), 3285813(4")		

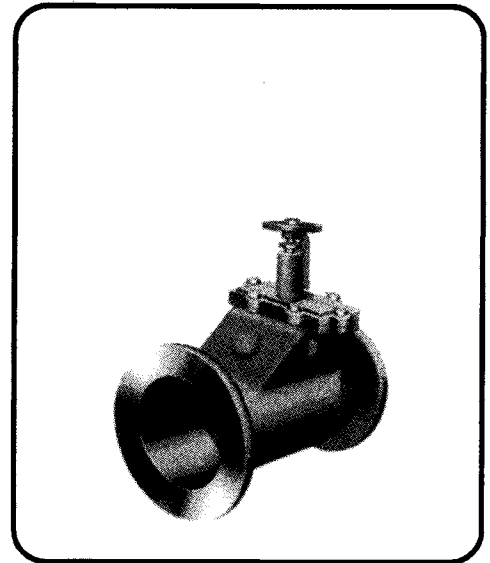

90° FLANGED COMMERCIAL (ANSI) or NAVY (MIL-F-20042)

Figure numbers	With Gag	No Gag
Outlet and Inlet same size	515081 Bronze	515080 Bronze
" " "	516081 Steel	516080 Steel
Outlet larger than Inlet (Comm)	515061 Bronze	515060 Bronze
" " "	516061 Steel	516060 Steel
Outlet special Navy, Inlet Std Navy	515131 Bronze	515130 Bronze
MIL-F-20042 DWGS 3285821(2")		
3285820(3"), 3285813(4")		

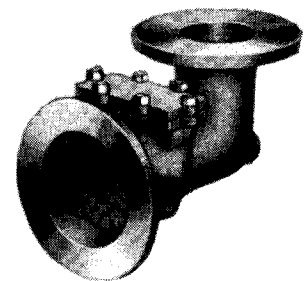

105° FLANGED NAVY (MIL-F-20042)

Figure numbers	With Gag	No Gag
Outlet special Navy, Inlet Std Navy	515121 Bronze	515120 Bronze
MIL-F-20042 DWGS 3285821(2")		
3285820(3"), 3285813(4")		

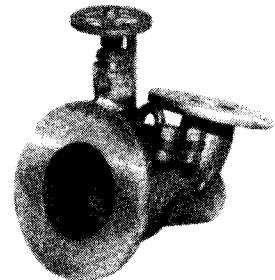

NAVY "HORIZONTAL" TYPE Flanged Navy (MIL-F-20042)

DWG 1385707

Bronze construction
With or without gag control

Figure numbers	With Gag	No Gag
Outlet special Navy, Inlet Std Navy	515141 Bronze	515140 Bronze
MIL-F-20042		

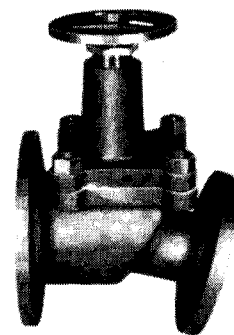

Scupper/Discharge fittings to DWG 3288519 available:

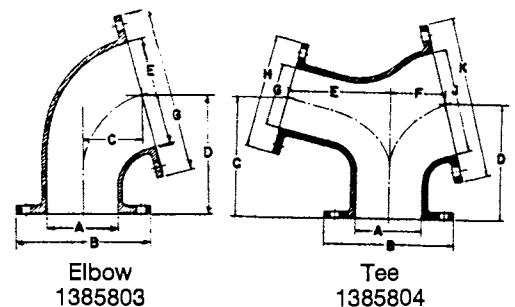

SOLENOID VALVES

MIL-R-16743

2 WAY SOLENOID VALVE

SIZE: 1/4" to 2"

DESIGN DESCRIPTION

Bronze body
 Silbraz union end
 or
 Flanged ends per MIL-F-20042
 Normally closed
 Steam, water or air service

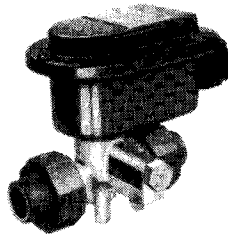

Steam
 AV 174

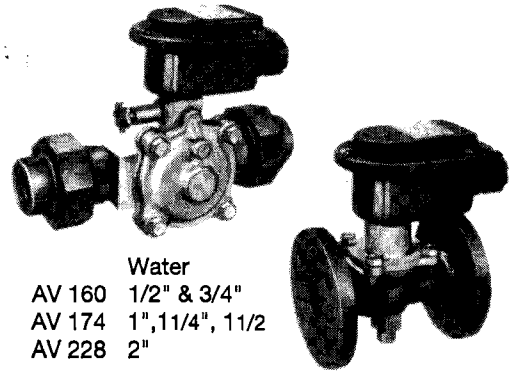

Water
 AV 160 1/2" & 3/4"
 AV 174 1", 1 1/4", 1 1/2"
 AV 228 2"

Water
 AV 172

2 WAY MANUAL RESET VALVE

SIZE: 3/4", 1 1/2", 2 1/2"

DESIGN DESCRIPTION

Steel body
 Welded pipe ends
 Overpressure trip valve for steam service system

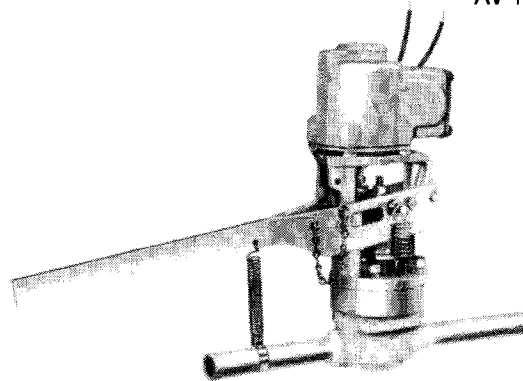

AV 170 3/4"
 AV 212 1 1/2"
 AV 89 2 1/2"

3 WAY MANUAL RESET "DUMP" VALVE

MIL-V-16556

SIZE: 1/2" to 1 1/2"

DESIGN DESCRIPTION

Bronze body
 Flanged ends per MIL-F-20042
 Used on fresh water distilling units

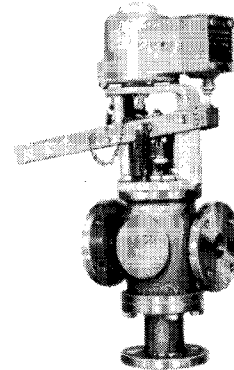

AV 182

QUICK CLOSE GLOBE VALVE

MIL-V-24569

SIZE: 1/2" to 2"

DESIGN DESCRIPTION

Forged steel body with stainless trim
 Flanged ends to 600 LB ANSI

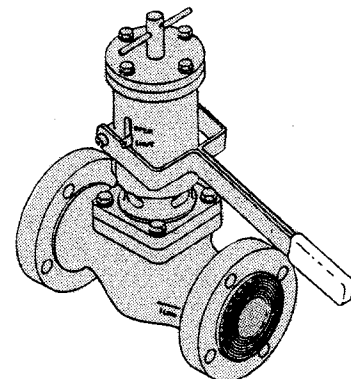

AV 212

The quick closing valve is installed in fuel oil and auxiliary steam systems to provide immediate shutoff of fluid in the system if required.

BRONZE SILBRAZE FITTINGS

MIL-F-1183
MIL-F-24227 (U.T. TYPE)

MATERIAL - B61 BRONZE

These fittings are used with IPS sized pipe/tubing. Typically supplied grooved for pre-inserted silver brazing ring. Available without groove ("face fed"). Specify as such.

Reducing fittings - add "R" to part number.

These fittings will not fit type K, L, M copper water tube which require solder joint fittings as shown on page 102.

FF = Female Braze End, Grooved
FPT = Female Pipe Thread
MF = Male Braze End
MPT = Male Pipe Thread

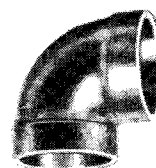

90 Ell
FF x FF 605101
FF x FPT 605102
FF x MF 605107
FF x MPT 605108



45 Ell
FF x FF 605104
FF x MF 605109



St 90 Ell
FF x MPT 605107
FF x MF 605108

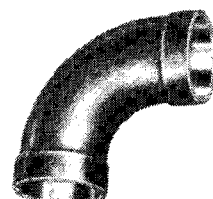

Long Turn 90
FF x FF 605111

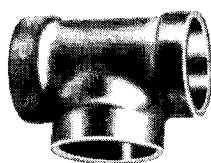

Tee
FF x FF x FF 605121
FF x FPT x FF 605122
FF x FF x FPT 605123
FF x FPT x FPT 605124

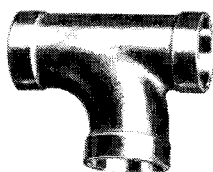

Single Sweep Tee
FF x FF 605130
FF x FPT 605131

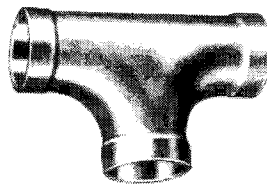

Double Sweep Tee
FF x FF 605133

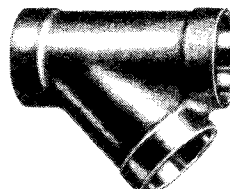

Y-Branch
FF x FF 605140

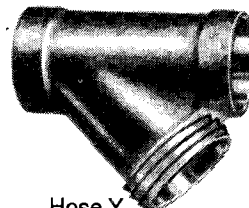

Hose Y
FF x Barb 605145
DWG 1385706



Plug
MF 605065

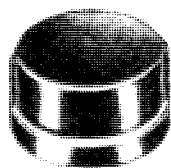

Cap
FF 605154



Coupling
FF x FF 605150
FF x FPT 605151



Reducer
FF x FF 605150R
FF x FPT 605151R



Hose Tee
FF x Barb 605144
DWG 1385706

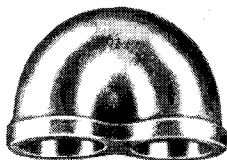

180 Return Bend
Closed
FF x FF 605155



180 Return Bend
Open
FF x FF 605156

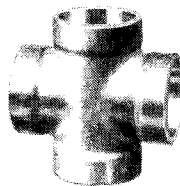

Cross
FF x FF 605135

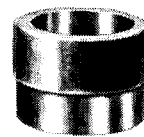

Bushing
MF x FF 605157

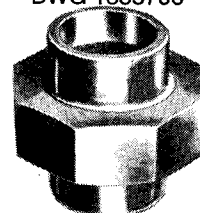

Union
FF x FF 605301
FF x FPT 605526
FF x MF 605527
FF x MPT 605528



Female Adapter
MF x FPT 605065



Male Adapter
Navy Adapter
Oversize Adapter
FF x Male Pipe Thread 605160
FF x one size larger MPT 605161
FF x more than one size larger 605162

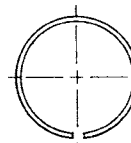

Silver Brazing Ring
605197 (GR.3)
605194 (GR.4)
605195 (GR.5)

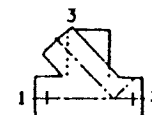

Reducing Fittings
Specify sizes 1-2-3
Add "R" to part #

BRONZE SILBRAZE UNIONS & FLANGES

MIL-F-1183

MIL-F-20042 FLANGES DWG 1385892 BUTTERFLY* FLANGES

MATERIAL: B61 BRONZE

Tailpieces are also available in 90/10, 70/30, monel and stainless
Also: U.T. end preparation, reducing outlet sizes, hose outlet end.

FF = Female Braze End (Grooved)

FPT = Female Pipe Thread

MF = Male Braze End

MPT = Male Pipe Thread

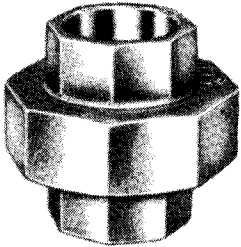

Union
FF x FF 605301
FF x FPT 605526
FF x MF 605527
FF x MPT 605528
FF x MPT 605529
one size larger



Threadpiece
FF 605299



Tailpiece
FF 605298
FPT 605294
MPT 605293
MF 605295
MPT 605296
one size larger



Nut
605297

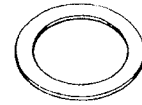

Retainer and O-ring
BRZ Retainer
with Buna O-ring
605347 Kit
605343 Buna O-ring
605344 EPR O-ring
605345 Viton O-ring
605346 BRZ Retainer

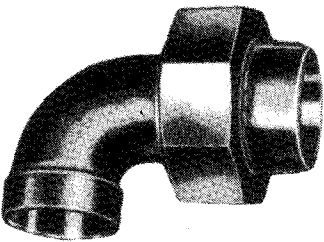

Union 90
FF x FF 605530
FF x FPT 605531
FF x MF 605532
FF x MPT 605533
FF x MPT 605534
one size larger

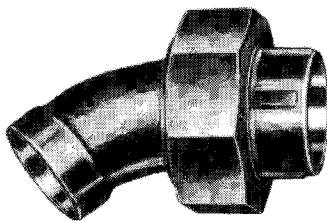

Union 45
FF x FF 605535
FF x FPT 605536
FF x MF 605537
FF x MPT 605538
FF x MPT 605539
one size larger

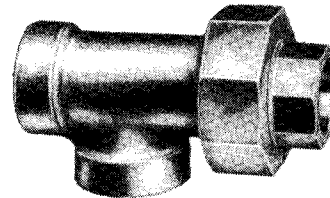

Union Run Tee
FF x FF 605540
FF x FPT 605541
FF x MF 605542
FF x MPT 605543
FF x MPT 605544
one size larger

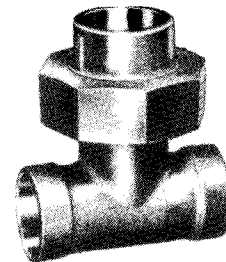

Union Outlet Tee
FF x FF 605545
FF x FPT 605546
FF x MF 605547
FF x MPT 605548
FF x MPT 605549
one size larger

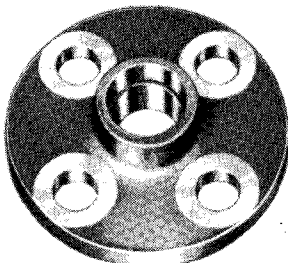

Silbraze
150 ANSI 605170
300 605570
150 Navy 605175
200* 605188
250 605181
400 605178
700 605179

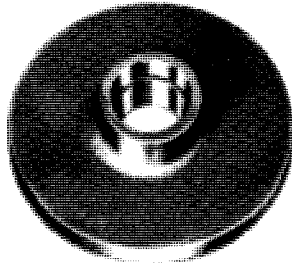

Silbraze Undrilled
150 ANSI 605270
150 Navy 605275
250 605281

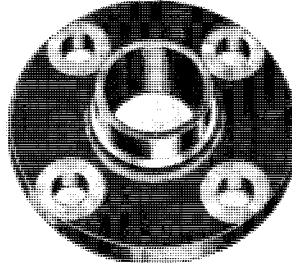

Male Silbraze
150 ANSI 605073
150 Navy 605075

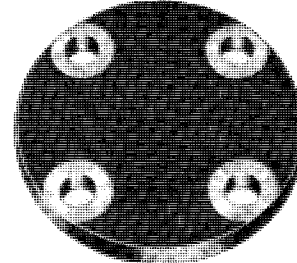

Blind
150 ANSI 605072
300 605076
150 Navy 605077
250 605081
400 605078

HIGH PRESSURE BRONZE SILBRAZE FITTINGS AND UNIONS

SIZES: 800 LB 2 1/2" to 12"
1500 LB 1/8" to 2"
3000 LB 1/8" to 2 1/2"

- DWG 1385766 - 800 / 1500 LB Fittings
1385863 - 800 / 1500 LB Bushings
1385859 - 800 / 1500 LB Unions
1385942 - 800 / 1500 LB Fittings U.T.
1385946 - 800 / 1500 LB Unions U.T.
- 841338 - 3000 LB Gageline Fittings
841626 - 3000 LB Gageline Unions
841337 - 3000 LB Union steel nut, rectangular gasket
- 1385883 - 3000 LB U.T. O-ring gasket
1385886 - 3000 LB O.D. Fittings
1385941 - 3000 LB Fittings U.T.
1385944 - 3000 LB Gageline Fittings U.T.
1385943 - 3000 LB Unions U.T. NI-CU nut, O-ring gasket
- 2068540 - 3000 LB Bushings and Reducers

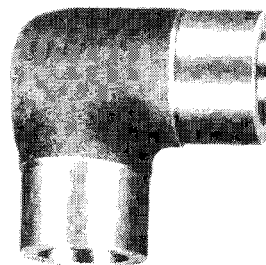

90 Ell
800/1500 606101
3000 607101
3000 UT 608101



45 Ell
606104
607104
608104

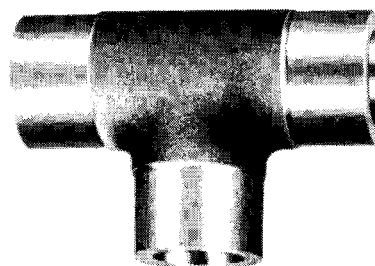

Tee
800/1500 606121
3000 607121
3000 UT 608121

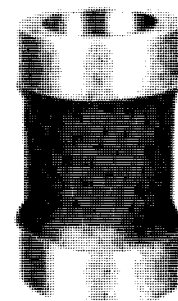

Coupling
606150
607150
608121

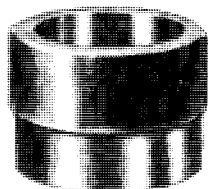

Bushing
800/1500 606157
3000 607157
3000 UT 608157

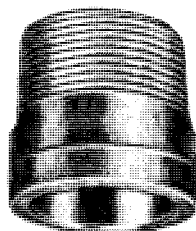

Male Adapter
606160
607160

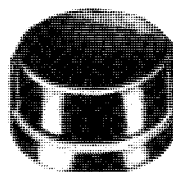

Cap
606154
607154
608154

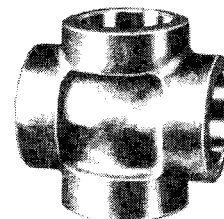

Cross
606135
607135
608135

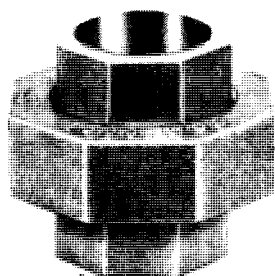

Union
O-ring Gasket
800/1500 606301



Union
Rectangular Gasket
3000 607301

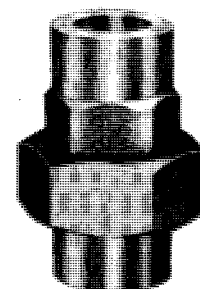

Union
O-ring Gasket
3000 UT 608301

COPPERNICKEL

SOCKETWELD FITTINGS

CAST 90/10 & 70/30

DWG 6397430

SIZES:	1/4" to 6"	200 PSI	425°F
	1/4" to 6"	400 WOG	150°F
	8" to 12"	150 PSI	425°F
	8" to 12"	200 WOG	150°F

Approved for use with Class 200 & 700 Coppernickel tubing in fire hazardous areas and systems. For high pressure 3000 LB and 6000 LB forged fittings: see page 185.

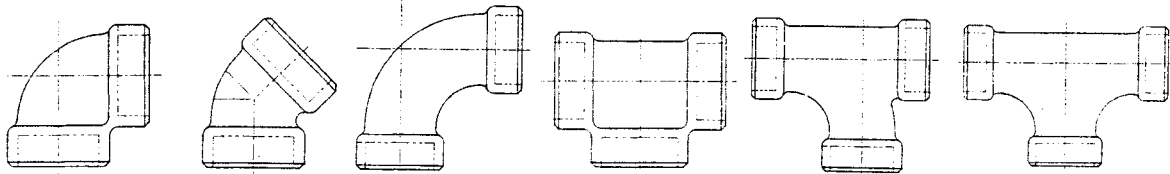

	90 El	45 El	Long Turn 90 El	Tee	Single Sweep Tee	Double Sweep Tee
90/10	640101	640104	640111	640121	640130	640133
70/30	650101	650104	650111	650121	650130	650133

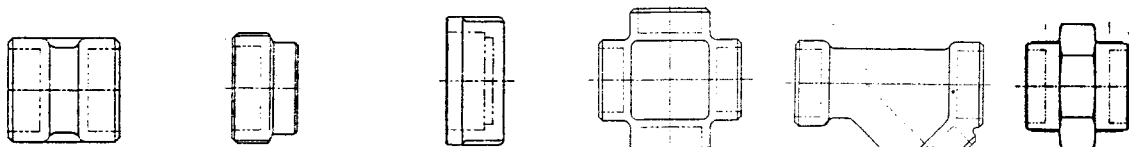

	Coupling	Bushing	Cap	Cross	Y Branch	Union
90/10	640150	640157	640154	640135	640140	640301
70/30	650150	650157	650154	650135	650140	650301

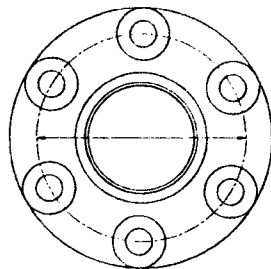

	150 Comm	150 Navy	250 Navy	150 Butterfly
	Flange	Flange	Flange	Flange
90/10	640170	640175	640181	640188
70/30	650170	650175	650181	650188

COPPERNICKEL

BUTTWELD FITTINGS

90/10 & 70/30

DWG 1385880 90/10 Class 200
 70/30 Class 200
 MIL-F-24202 70/30 Class 700

Schedule 40 fittings are dimensioned ANSI B16.9 as shown next page.
 Fittings available in metric and imperial sizes as listed page 104.

DIMENSIONS

IPS Size	OD Max	Wall CL 200	Wall CL 700	A LR 90* or SS or D.S. Tee	B LR 45 Elbow	E Tee or Cross	L Reducer Con or Ecc	S SR 90* Elbow	C Cap End	M Stub End	W Sleeve ID=IPSOD	H 45° Y Lateral
1/2	.840	.065	.072	115/16		1				2	3/4	
3/4	1.05	.065	.083	119/32		1 1/8	1 1/2			2	13/16	
1	1.31	.065	.095	2	11/8	2	2	11/2	11/2	2	7/8	61/4
1 1/4	1.66	.072	.095	27/16	111/32	17/8	2	113/16	11/2	2	1	613/16
1 1/2	1.90	.072	.109	215/16	15/8	21/4	2 1/2	23/16	11/2	2	1 1/4	711/16
2	23/8	.083	.120	323/32	131/32	2 1/2	3	223/32	11/2	2 1/2	15/16	823/32
2 1/2	27/8	.083	.134	45/8	27/16	3	3 1/2	33/8	11/2	2 1/2	19/16	103/8
3	3 1/2	.095	.165	513/32	249/64	33/8	3 1/2	329/32	2	2 1/2	121/32	1029/32
3 1/2	4	.109	.180	61/4	311/64	33/4	4	47/16	2 1/2	3	13/4	127/16
4	4 1/2	.109	.203	631/32	329/64	4 1/8	4	431/32	2 1/2	3	1 13/16	13
5	59/16	.125	.220	819/32	413/64	47/8	5	63/32	3	3	2 1/16	1419/32
6	65/8	.134	.259	1011/64	429/64	55/8	5 1/2	711/64	3 1/2	3 1/2	27/32	1511/16
8	85/8	.148	.340	133/8	611/32	7	6	93/8	4	4	25/8	187/8
10	103/4	.187	.380	169/16	725/32	8 1/2	7	119/16	5	5	3	
12	123/4	.250	.454	1911/16	99/64	10	8	1111/16	6	6	3 1/4	
14	14			211/2	91/4	11	13	141/2	6 1/2	6		
16	16			241/2	101/2	12	14	161/2	7	6		
18	18			271/2	113/4	13 1/2	15	181/2		6		
20	20			301/2	13	15	20	20 1/2		6		
24	24			361/2	15 1/2	17	20	24 1/2		6		



	LR 90	LR 45	Tee	Conc Red	SR 90	Cap	Stub End	Sleeve	Lateral
90/10 CL 200	601111	601104	601120	601150	601101	601154	601159	601155	601140
70/30 CL 200	602111	602104	602120	602150	602101	602154	602159	602155	602140
70/30 CL 700	607211	607204	607220	607250	607201	607254	607259	607255	607240

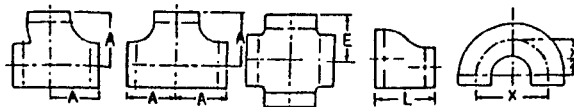

	Single Sweep Tee	Double Sweep Tee	Cross	Eccentric Reducer	180° Return
90/10 CL 200	601130	601133	601135	601149	601156
70/30 CL 200	602130	602133	602135	602149	602156

Reducing fittings: LR 90, Tee, SS Tee, DS Tee, Cross, Y Lateral add "R" Suffix + Specify sizes 1-2-3 as shown at right.
 * Class 700 LR 90 + SR 90 dimensions differ from chart. They are slightly less than the Class 200 dimensions shown.

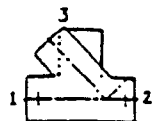

WELDING FITTINGS

Dimensions shown cover steel, stainless steel, aluminum, monel and copper nickel (in Sch 40 only: uncommon and costly) but not Class 200/700. Copper nickel in Class 200/700 dimensions, matching common copper nickel pipe wall thicknesses: pg 181, 110.

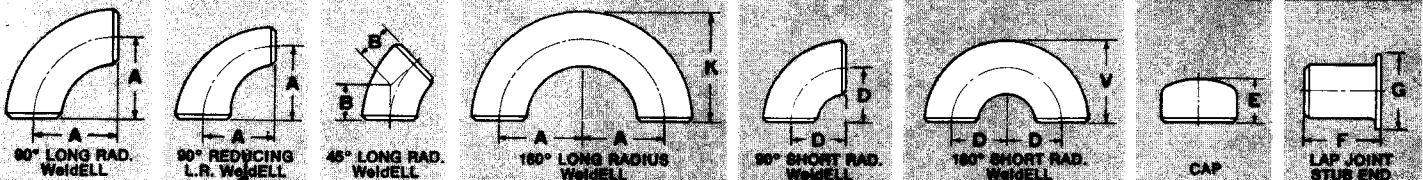

Nom. Pipe Size	Pipe O.D.	WALL THICKNESS													A	B	K	D	V	E	F		G	Nom. Pipe Size
		Light Wall	Sch 20	Sch 30	Sch 40	Sch 60	X-Stg	Sch 80	Sch 100	Sch 120	Sch 140	Sch 160	XX-Stg	ASA							MSS			
1/2	.840	.083109	.109147	.147188	.294	1 1/2	3/8	1 1/8	1	3	2	1 1/8	1/2
3/4	1.050	.083113	.113154	.154219	.308	1 1/2	3/8	1 1/8	1	3	2	1 1/8	3/4
1	1.315	.109133	.133179	.179250	.358	1 1/2	3/8	2 3/8	1	1 1/2	1 1/2	4	2	2	1
1 1/4	1.660	.109140	.140191	.191250	.382	1 1/2	1	2 1/4	1 1/4	2 1/2	1 1/2	4	2	2 1/2	1 1/4
1 1/2	1.900	.109145	.145200	.200281	.400	2 1/4	1 1/4	3 1/4	1 1/2	2 3/8	1 1/2	4	2	2 1/2	1 1/2
2	2.375	.109154	.154218	.218344	.436	3	1 1/4	4 3/8	2	3 3/8	1 1/2	6	2 1/2	3 3/8	2
2 1/2	2.875	.120203	.203276	.276375	.552	3 3/4	1 1/4	5 3/8	2 1/2	3 1 1/8	1 1/2	6	2 1/2	4 1/8	2 1/2
3	3.500	.120216	.216300	.300438	.600	4 1/2	2	6 1/4	3	4 1/2	2	6	2 1/2	5	3
3 1/2	4.000	.120226	.226318	.318438	.636	5 1/4	2 1/4	7 1/4	3 1/2	5 1/2	2 1/2	6	3	5 1/2	3 1/2
4	4.500	.120237	.237337	.337438531	.674	6	2 1/2	8 1/4	4	6 1/4	2 1/2	6	3	6 3/8	4
5	5.563	.134258	.258375	.375500625	.750	7 1/2	3 3/8	10 1/8	5	7 3/4	3	8	3	7 3/8	5
6	6.625	.134280	.280432	.432562719	.864	9	3 3/8	12 3/8	6	9 3/8	3 1/2	8	3 1/2	8 1/2	6
8	8.625	.148	250	277	.322	.322	.406	.500	.500	.594	.719	.812	.906	.875	12	5	16 3/8	8	12 3/8	4	8	4	10 3/8	8
10	10.750	.165	250	.307	.365	.365	.500	.500	.594	.719	.844	1.000	1.125	1.000	15	6 1/4	20 1/8	10	15 1/8	5	10	5	12 1/2	10
12	12.750	.180	250	.330	.375	.406	.562	.500	.688	.844	1.000	1.125	1.312	1.000	18	7 1/2	24 1/8	12	18 3/8	6	10	6	15	12
14	14.000	.250	312	.375	.375	.438	.594	.500	.750	.938	1.094	1.250	1.406	...	21	8 3/8	28	14	21	6 1/2	12	...	16 1/2	14
16	16.000	.250	312	.375	.375	.500	.656	.500	.844	1.031	1.219	1.438	1.594	...	24	10	32	16	24	7	12	...	18 1/2	16
18	18.000	.250	312	.438	.375	.562	.750	.500	.938	1.156	1.375	1.562	1.781	...	27	11 1/4	36	18	27	8	12	...	21	18
20	20.000	.250	375	.500	.375	.594	.812	.500	1.031	1.281	1.500	1.750	1.969	...	30	12 1/2	40	20	30	9	12	...	23	20
24	24.000	.250	375	.562	.375	.688	.969	.500	1.219	1.531	1.812	2.062	2.344	...	36	15	48	24	36	10 1/2	12	...	27 1/2	24
30	30.000	.312	.500	.625	.375500	45	18 1/2	60	30	45	10 1/2	30
36	36.000	.312	.500	.625	.375	.750500	54	22 1/4	...	36	54	10 1/2	36
42	42.000375500	63	26	...	42	...	12	42
48	48.000375500	72	29 3/4	...	48	...	13 1/2	48

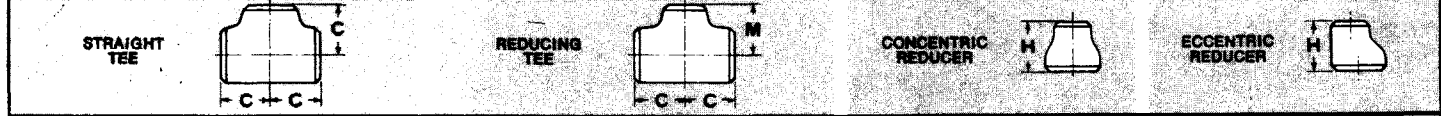

Nom. Pipe Size	Outlet	C			Nom. Pipe Size	Outlet	C			Nom. Pipe Size	Outlet	C			Nom. Pipe Size	Outlet	C		
		M	H	M			H	M	H			M	H	M			H		
3/4	3/4	1 1/8	3 1/2	3 3/4	10	10	8 1/2	20	20	15	
1	1	1 1/2		3 3/4	3 3/4	3 3/4		4	8	8 1/2	8		...	7	18	15	14 1/2
1 1/4	1 1/4	1 1/2	2	3 3/4	3 3/4	3 3/4	4	6	8 1/2	7 3/8	7	16	15	14	...	20	
1 1/2	1 1/2	1 1/2	1 1/2	3 3/4	3 3/4	3 3/4	4	5	8 1/2	7 1/2	7	14	15	13 3/8	...	20	
1 3/4	1 3/4	1 1/2	4	8 1/2	7 1/4	7	10	15	13 3/8	...	20	
2	2	2 1/4	4	4 1/4	12	10	24	17	
2 1/2	2 1/2	2 1/4	3 1/2	4 1/4	4 1/4	4	...	10	10	9 1/2	8	20	17	17	
3	3	2 1/4	3	4 1/4	3 3/4	4	...	8	10	9	8	18	17	16 1/2	
3 1/2	3 1/2	2 1/4	2 1/2	4 1/4	3 3/4	4	...	6	10	8 3/8	8	16	17	16	
4	4	2 1/4	2	4 1/4	3 1/2	4	...	5	10	8 1/2	8	14	17	16	
4 1/2	4 1/2	2 1/4	1 1/2	4 1/4	3 3/4	4	...	12	10	8 1/2	8	12	17	15 1/2	
5	5	2 1/4	14	11	10	17	15 3/8	
5 1/2	5 1/2	2 1/4	5	4 3/4	12	11	10 3/8	13	30	22	
6	6	2 1/4	4	4 3/4	4 1/2	5	...	10	11	10 3/8	13	24	22	21	
6 1/2	6 1/2	2 1/4	3	4 3/4	4 1/2	5	...	8	11	9 3/4	13	20	22	20	
7	7	2 1/4	2 1/2	4 3/4	4 1/2	5	...	6	11	9 3/4	13	18	22	19 1/2	
7 1/2	7 1/2	2 1/4	16	12	16	22	19	
8	8	2 1/4	6	5 1/4	14	12	12	14	14	22	19	
8 1/2	8 1/2	2 1/4	5	5 1/4	5 1/4	5 1/2	...	12	12	11 3/8	14	36	26 1/2	
9	9	2 1/4	4	5 1/4	5 1/4	5 1/2	...	10	12	11 3/8	14	30	26 1/2	25	
9 1/2	9 1/2	2 1/4	3 1/2	5 1/4	5 1/4	5 1/2	...	8	12	10 3/4	14	24	26 1/2	24	
10	10	2 1/4	3	5 1/4	4 3/4	5 1/2	...	6	12	10 3/8	14	20	26 1/2	23	
10 1/2	10 1/2	2 1/4	2 1/2	5 1/4	4 3/4	5 1/2	...	18	13 1/2	18	26 1/2	22 1/2	
11	11	2 1/4	16	13 1/2	16	26 1/2	22	
11 1/2	11 1/2	2 1/4	6	5 1/4	5 1/4	5 1/2	...	14	13 1/2	13	15	42	30	28	
12	12	2 1/4	5	5 1/4	5 1/4	5 1/2	...	12	13 1/2	13	15	36	30	28	
12 1/2	12 1/2	2 1/4	4	5 1/4	4 3/4	5 1/2	...	10	13 1/2	12 1/2	15	30	30	28	
13	13	2 1/4	3 1/2	5 1/4	4 3/4	5 1/2	...	8	13 1/2	12 1/8	15	24	30	26	
13 1/2	13 1/2	2 1/4	2 1/2	5 1/4	4 3/4	5 1/2	...	18	13 1/2	11 3/4	15	20	30	26	
14	14	2 1/4	16	13 1/2	11 3/4	15	18	30	26	

STEEL AND ALLOY BUTTWELD FITTINGS

ANSI B16.9

SIZES: 1/2" to 24"

Ordering Info: by *description* or codes + size

Steel A234 WPB MIL-F-20236	STD	614 + Fitting Code Number (see below) + Size
	XH	615
	SCH 160	617
	XXH	618
Chromemoly P11/P22	STD	619
ASTM A182	XH	620
Stainless 304/316/321/347	SCH 10	653
ASTM A182	SCH 40	654
	SCH 80	655
	SCH 160	656
Aluminum 6061	STD	664
	XH	665
Aluminum 5086	STD	666
	XH	667
Monel 400	STD	668
	XH	669



180 Return
Long / Open



180 Return
Short / Closed

Copper Nickel

see page 181

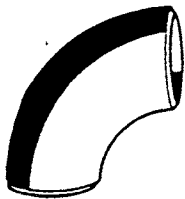

90 Ell
Long Radius
111

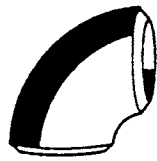

90 Ell
Short Radius
101



45 Ell
104

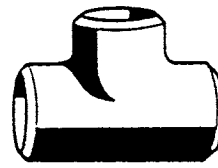

Tee
121

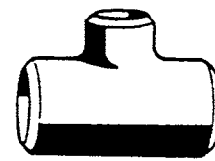

Tee
Reducing
122

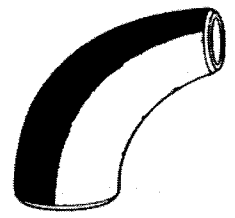

90 Ell
Reducing
112



Cap
154



Concentric
Reducer
150



Eccentric
Reducer
149



Lateral
140



Stub End
159

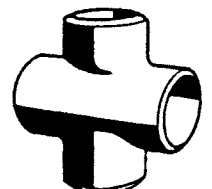

Cross
135

BOSSSES & OUTLETS

Outlet fittings are designed to be welded onto an existing "run" of pipe to provide a branch or "outlet" connection without having to cut run pipe. Outlet connection can be threaded, socketweld, braze, or buttweld. Outlet fittings provide 90° or 45° (elbolet) connections. They are typically described by two sizes: "run" by "outlet". For example a 4x2 sockolet fits on a 4" run of pipe with a 2" socket outlet size.

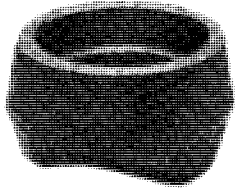

Socket/Braze Outlet

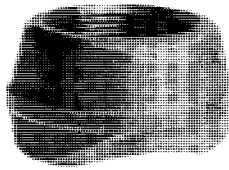

FPT Outlet

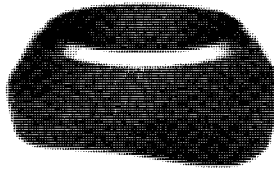

Buttweld Outlet



Boss
DWG 1385912
DWG 1385950

Bronze	695320	695310	—	—
90/10	695120	695110	695130	695140
70/30	695220	695210	695230	695240
Steel	695420	695410	695430	695440
Stainless	695720	695710	695730	695740
Monel	695920	695410	695430	695940
Aluminum	695620	695610	695630	695640
F11 Steel	695520	695510	695530	695540

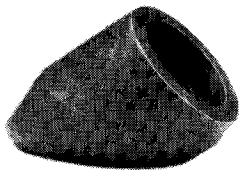

Elbow Socket/Braze Outlet



Elbow FPT Outlet

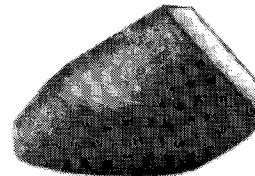

Elbow Buttweld Outlet

Bronze	697320	697310	697330
90/10	697120	697110	697130
70/30	697220	697210	697230
Steel	697420	697410	697430
Stainless	697720	697710	697730
Monel	697920	697910	697930
Aluminum	697620	697610	697630
F11 Steel	697520	697510	697530

ADAPTERS AND GAGELINE FITTINGS

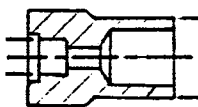

1/4 IPS x 1/4 OD
Gageline Bushing
DWG 2068540
DWG 1385850

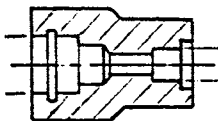

1/4 IPS x 1/4 OD
Gageline Coupling
DWG 2068540
DWG 1385850

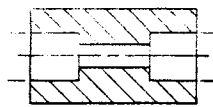

1/4 OD
Gageline Coupling
DWG 1385850

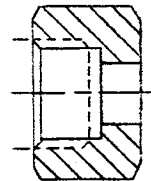

1/4 OD
Union Nut
DWG 1385850

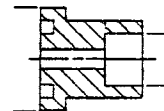

1/4 OD
Tailpiece
DWG 1385850

Bronze	607157	607150R	607150	607297	607298
90/10	642157	642150R	642150	642297	642298
70/30	647157	647150R	647150	647297	647298
Steel	622157	622150R	622150	622297	622298
Stainless	652157	652150R	652150	652297	652298
Monel	635157	635150R	635150	635297	635298

STEEL AND ALLOY FORGED FITTINGS

ANSI B16.11

SIZES: 1/8" to 4"

Ordering Info: by *description* or code numbers

Steel	A105	3000 LB	Threaded	621 + Fitting Code (see below) + Size
		3000 LB	Socketweld	622
		6000 LB	Socketweld	624
Chromemoly	F11	3000 LB	Socketweld	626
		3000 LB	Socketweld	628
90/10 CopperNickel MIL-C-15726		200/400 LB*	Socketweld*	640
		3000 LB	Threaded	641
		3000 LB	Socketweld	642
70/30 CopperNickel MIL-C-15726		200/400 LB*	Socketweld*	645
		3000 LB	Threaded	646
		3000 LB	Socketweld	647
Monel Nickel Copper QQ-N-288		3000 LB	Threaded	634
		3000 LB	Socketweld	635
Aluminum	6061	3000 LB	Threaded	661
		3000 LB	Socketweld	662
Aluminum	5086	3000 LB	Socketweld	664
Stainless	304/316 St/L	3000 LB	Threaded	651/651L
		3000 LB	Socketweld	652/652L

Also Available: 6000 + 9000 LB rated fittings

Also Available: Inconel, 321, 347, A20 and other alloys

*This is a cast fitting, not forged, and listed on page 180

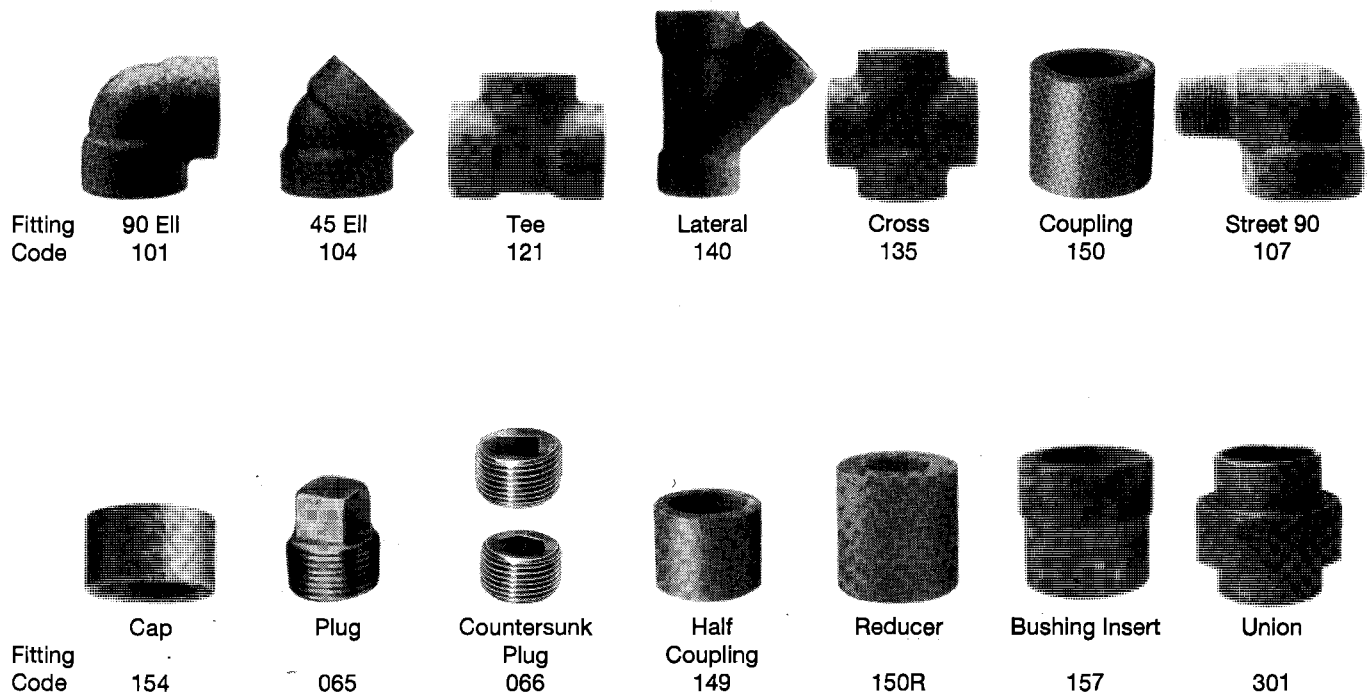

COPPER FUNNELS

SIZES: 1/2" to 12"

DWG 4715320

Round 524101
Oval 524102

DWG 3160733

Round 524101
Oval 524102

DWG 1889635

Rect. 524103
Oval 524104

DWG 1385913

Round 524105

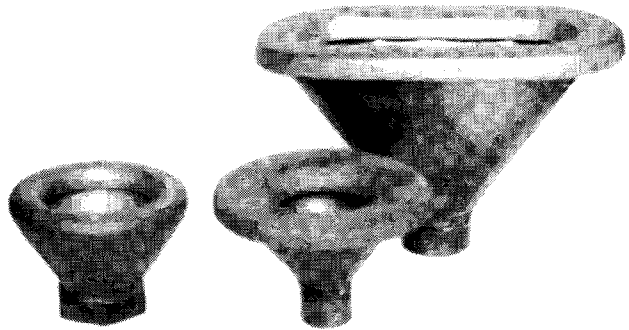

BELLMOUTH

DWG 1385792

SIZES: 1 1/4" to 10"

MATERIAL: 90/10 or 70/30 CopperNickel

Bellmouths are used for fuel tank filling or stripping operations and/or deballasting.

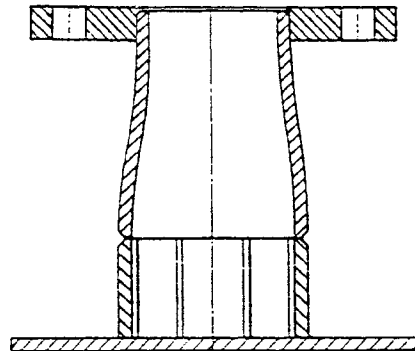

FLANGED x SILBRAZE FITTINGS

DWG 1889620

Bronze material
Navy or Commercial drilled

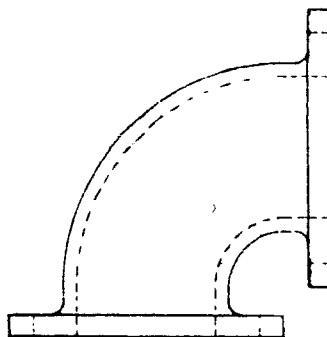

Flanged Fittings

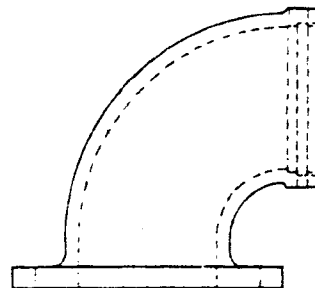

Flanged x Silbraze Fittings

O-SEAL FITTINGS

3000 - 6000 PSI

MATERIALS: Bronze 70/30, Monel, Stainless, Steel

DIMENSIONS: Per Drawing



Socket/Braze

Union

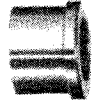

Socket/Braze

Tailpiece



Union

Nut

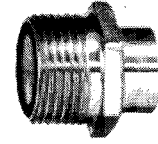

Socket Braze

Threadpiece

Bronze	645301	645298	645297	645299
Steel	646301	646298	646297	646299
Stainless	647301	647298	647297	647299
70/30	648301	648298	648297	648299
Monel	649301	649298	649297	649299

Also available: Tailpiece and Threadpiece with threaded or buttweld connection.

AEROQUIP FITTINGS

MATERIAL: Monel

37° Flare (JIC) x Silbraze Adapters, IPS Pipe Size & OD Tube Size

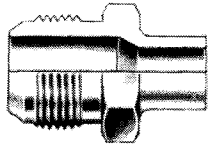

4-202142 (Pipe) & 4-202140 (Tube)
37° JIC x Male Silbraze
635901

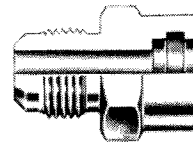

4-202242 (Pipe) & 4-202240 (Tube)
37° JIC x Female Silbraze
635902

MECHANICAL FITTINGS

SIZES: 1/8" to 1 1/2" IPS Pipe or OD Tube Sizes

MATERIALS: Stainless, 70/30 Copper Nickel and Steel

RATINGS: 3750 PSI and 6000 PSI

Fittings are connected to pipe or tube by hydraulic swaging with special tool.



	90 Ell	45 Ell	Coupling	Tee	Flange
SS 3750 LB	836101	836104	836150	836121	836170
SS 6000 LB	837101	837104	837150	837121	837170
70/30 3750 LB	838101	838104	838150	838121	838170
70/30 6000 LB	839101	839104	839150	839121	839170

NAVY FLANGE DIMENSIONS

100/150 LB. MIL-F-20042 Flanges

SIZE	Diameter	Thickness	Bolt Circle	No. Of Holes	Hole Size
1/4	3 1/4	3/8	2 1/8	3	9/16
3/8	3 3/8	3/8	2 1/4	3	9/16
1/2	3 9/16	3/8	2 7/16	3	9/16
3/4	3 13/16	7/16	2 11/16	4	9/16
1	4 1/4	7/16	3 1/8	4	9/16
1 1/4	4 1/2	7/16	3 3/8	4	9/16
1 1/2	5 1/16	7/16	3 5/16	6	9/16
2	5 9/16	7/16	4 7/16	6	9/16
2 1/2	6 1/8	1/2	5	6	9/16
3	6 5/8	1/2	5 1/2	8	9/16
3 1/2	7 3/16	1/2	6 1/16	8	9/16
4	7 11/16	1/2	6 9/16	8	9/16
4 1/2	8 3/16	1/2	7 1/16	10	9/16
5	9 1/16	9/16	7 13/16	10	11/16
6	10 1/8	9/16	8 7/8	12	11/16
7	11 5/16	9/16	10	12	11/16
8	12 3/8	5/8	11 1/16	14	11/16
9	13 15/16	11/16	12 3/8	14	13/16
10	15	11/16	13 7/16	15	13/16
11	16 9/16	11/16	15	16	13/16
12	17 5/8	3/4	16 1/16	18	13/16

250 LB. MIL-F-20042 Flanges

SIZE	Diameter	Thickness	Bolt Circle	No. Of Holes	Hole Size
1/4	3 1/4	11/16	2 1/8	3	9/16
3/8	3 3/8	11/16	2 1/4	3	9/16
1/2	3 9/16	11/16	2 7/16	3	9/16
3/4	3 13/16	11/16	2 11/16	4	9/16
1	4 1/4	3/4	3 1/8	4	9/16
1 1/4	4 1/2	13/16	3 3/8	4	9/16
1 1/2	5 1/16	13/16	3 5/16	6	9/16
2	5 9/16	13/16	4 7/16	6	11/16
2 1/2	6 1/8	15/16	5	6	11/16
3	6 5/8	15/16	5 1/2	8	11/16
3 1/2	7 3/16	1	6 1/16	8	11/16
4	7 11/16	1	6 9/16	8	11/16
4 1/2	8 3/16	1	7 1/16	10	11/16
5	9 1/16	1 1/16	7 13/16	10	11/16
6	10 1/8	13/16	8 7/8	12	11/16
7	11 5/16	1 1/4	10	12	11/16
8	12 3/8	1 5/16	11 1/16	14	11/16
9	13 15/16	1 3/8	12 3/8	14	13/16
10	15	1 7/16	13 7/16	15	13/16
11	16 9/16	1 1/2	15	16	13/16
12	17 5/8	1 1/2	16 1/16	18	13/16

200 LB DWG 1385892 Butterfly Flanges

SIZE	Diameter	Thickness	Bolt Circle	No. Of Holes	Hole Size
3/8	3 1/2	5/16	2 3/8	4	5/8
1/2	3 1/2	5/16	2 3/8	4	5/8
3/4	3 7/8	11/32	2 3/4	4	5/8
1	4 1/4	3/8	3 1/8	4	5/8
1 1/4	4 5/8	13/32	3 1/2	4	5/8
1 1/2	5	7/16	3 7/8	4	5/8
2	6	1/2	4 3/4	4	3/4
2 1/2	7	9/16	5 1/2	4	3/4
3	7 1/2	5/8	6	4	3/4
3 1/2	8 1/2	11/16	7	8	3/4
4	9	11/16	7 1/2	8	3/4
5	10	3/4	8 1/2	8	7/8
6	11	13/16	9 1/2	8	7/8
8	13 1/2	15/16	11 3/4	8	7/8
10	16	1	14 1/4	12	1
12	19	1 1/8	17	12	1

400 LB. MIL-F-20042 Flanges

SIZE	Diameter	Thickness	Bolt Circle	No. Of Holes	Hole Size
1/4	3 3/4	11/16	2 5/8	3	9/16
3/8	3 7/8	11/16	2 3/4	4	9/16
1/2	4	11/16	2 7/8	4	9/16
3/4	4 5/16	11/16	3 3/16	4	9/16
1	5 1/16	3/4	3 3/4	5	11/16
1 1/4	5 3/8	13/16	4 1/16	5	11/16
1 1/2	5 15/16	13/16	4 5/8	6	11/16
2	6 1/2	13/16	5 3/16	7	11/16
2 1/2	7 9/16	15/16	6	8	13/16
3	8 1/8	15/16	6 9/16	8	13/16
3 1/2	8 11/16	1	7 1/8	9	13/16
4	9 1/4	1	7 11/16	9	13/16
5	10 3/8	1 1/16	8 13/16	11	13/16
6	11 15/16	13/16	10 3/16	12	15/16
8	14 3/4	1 5/16	12 3/4	13	1 1/16
10	17	1 7/16	15	15	1 1/16

50 LB. MIL-F-20042 Flanges

SIZE	Diameter	Thickness	Bolt Circle	No. Of Holes	Hole Size
12	16 9/16	11/16	15	16	13/16
14	19 1/8	3/4	17 3/8	19	15/16
16	21 3/16	3/4	19 7/16	20	15/16
18	23 1/4	7/8	21 1/2	22	15/16
20	25 13/16	7/8	23 13/16	24	1 1/16
22	27 7/8	7/8	25 7/8	26	1 1/16
24	30	1	28	28	1 1/16
26	32 9/16	1	30 5/16	30	1 3/16
28	34 11/16	1	32 7/16	32	1 3/16
30	36 13/16	1 1/8	34 9/16	35	1 3/16
32	39	1 1/8	36 3/4	36	1 3/16
34	41	1 1/8	38 3/4	36	1 3/16
36	43 7/8	1 1/4	41 3/8	36	1 5/16
38	46 1/8	1 1/4	43 5/8	36	1 5/16
40	48 1/8	1 1/4	45 5/8	36	1 5/16

700 LB. DWG 1385947 Flanges

SIZE	Diameter	Thickness	Bolt Circle	No. Of Holes	Hole Size
1/4	3 1/4	11/16	2 1/8	3	9/16
3/8	3 3/8	11/16	2 1/4	3	9/16
1/2	3 9/16	11/16	2 7/16	3	9/16
3/4	3 13/16	11/16	2 11/16	4	9/16
1	4 1/4	3/4	3 1/8	4	9/16
1 1/4	4 1/2	13/16	3 3/8	4	9/16
1 1/2	5 1/16	13/16	3 5/16	6	9/16
2	5 9/16	15/16	4 7/16	6	11/16
2 1/2	6 1/8	1 1/16	5	6	11/16
3	7 7/16	1 3/8	5 15/16	8	11/16
3 1/2	8	1 7/16	6 1/2	8	11/16
4	8 11/16	1 7/16	7 3/16	10	11/16
5	9 3/4	1 5/8	8 1/4	12	11/16
6	10 7/8	1 15/16	9 3/8	14	11/16
8	13 1/8	2 1/8	11 5/8	16	11/16

FLANGES - COPPERNICKEL 90/10 AND 70/30

				90/10	70/30
DWG 4715319	1A	150 Navy	Slip On	689000	687000
	2A	150 Navy	Socketweld	689040	687040
	2A	200 Navy	Butterfly SW	689188	687188
	2A	250 Navy	Slip On	689200	687200
	2A	50 Navy	Socketweld	689040	687040
	2A	150 Navy	Socketweld	689240	687240
DWG 1385992		250 Navy	Weldneck	689260	687260
DWG 1889897		700 Navy	Socketweld	689740	687740
		700 Navy	Weldneck	689760	687760
Commercial		150 ANSI	Slip On	689100	687100
		150 ANSI	Socketweld	689140	687140
		150 ANSI	Weldneck	689160	687160
		150 ANSI	Blind	689180	687180
		300 ANSI	Slip On	689300	687300
		300 ANSI	Socketweld	689340	687340
		300 ANSI	Blind	689380	687380

Flange dimensions and drilling information listed on pages 188 and 197.

FLANGES - BRONZE

ASTM B-61

			Bronze
MIL-F-20042	Navy 150	Silbraz	605175
		Blind	605077
		Male	605075
	Navy 250	Silbraz	605181
		Blind	605081
		Silbraz	605178
	Navy 400	Blind	605078
		Silbraz	605179
	DWG 1385892	Butterfly 200	Silbraz
Commercial	ANSI 150	Silbraz	605170
		Blind	605072
		Male	605073
	ANSI 300	Silbraz	605570
		Blind	605074
Hose Flange	Navy 150	Male Hose	605195
	Navy 250	Male Hose	605196
	ANSI 150	Male Hose	605191

Flange dimensions and drilling information listed on pages 188 and 197.

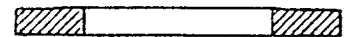

Slip On

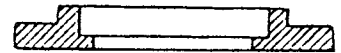

Socketweld

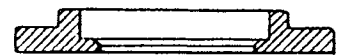

Butterfly Socketweld



Weldneck

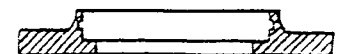

Silbraz



Blind



Male



Male Hose

FLANGES - STEEL AND ALLOY

Ordering Info: by *description* or codes + size

Flange dimensions and drilling information listed on pages 199-203.
ANSI flanges have raised face unless ordered "FF" flat face.

Steel	A105		680 + Pressure/Style Code (below) + size
	MIL-F-20670	B-110	678
	MIL-F-17823	300LB	680
	DWG 64496	600LB	680
	DWG 1385861	700LB	680
Chromemoly	F11		681
Chromemoly	F22		682
Monel	NiCu		689
Aluminum	6061		660
Aluminum	5086		669
Stainless	304/316		670

Copper Nickel & Bronze see page 189

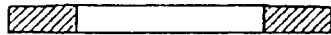

Slip On - Type C		
Navy	150 LB	000
	250 LB	200

ANSI Slip On		
	150 LB	100
	300 LB	300
	600 LB	600
	900 LB	800
	1500 LB	900

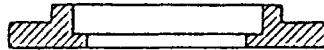

Socketweld - Type D Mod		
Navy	150 LB	040
	250 LB	240

ANSI Socketweld		
	150 LB	140
	300 LB	340
	600 LB	640
	900 LB	840
	1500 LB	940



Weldneck - Type D		
Navy	150 LB	060
	250 LB	260

ANSI Weldneck		
	150 LB	160
	300 LB	360
	600 LB	660
	900 LB	860
	1500 LB	960



Threaded		
ANSI	150 LB	120
	300 LB	320
	600 LB	620
	900 LB	820
	1500 LB	920



Blind		
Navy	150 LB	080
	250 LB	280
ANSI	150 LB	180
	300 LB	380
	600 LB	680
	900 LB	880
	1500 LB	980

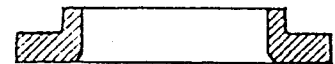

Lap Joint		
ANSI	150 LB	190
	300 LB	390
	600 LB	690

MILITARY SPEC PIPE AND TUBING STEEL & ALLOY

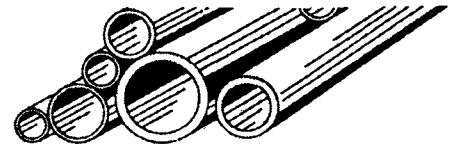

PIPE SIZE CHART

IPS SIZE	OD	STD Wall	XH Wall	SCH10 Wall
1/8	.405	.068	.095	.049
1/4	.540	.088	.119	.065
3/8	.675	.091	.126	.065
1/2	.840	.109	.147	.083
3/4	1.050	.113	.154	.083
1	1.315	.133	.179	.109
1 1/4	1.660	.140	.191	.109
1 1/2	1.900	.145	.200	.109
2	2.375	.154	.218	.109
2 1/2	2.875	.203	.276	.120
3	3.500	.216	.300	.120
3 1/2	4.000	.226	.318	.120
4	4.500	.237	.337	.120
5	5.563	.258	.375	.134
6	6.625	.280	.432	.134
8	8.625	.322	.500	.148
10	10.75	.365	.580	.165
12	12.75	.375	.500	.180
14	14.00	.375	.500	.250
16	16.00	.375	.500	.250
18	18.00	.375	.500	.250
20	20.00	.375	.500	.250
24	24.00	.375	.500	.250

SIZES: 1/8" to 36"

STEEL	SCH 40	SCH 80
MIL-P-24691/1	782040	782080
MIL-T-20157(old)	781040	781080
MIL-T-16343	780040	780080
ASTM A106	771040	771080

CHROMEMOLY P11		
MIL-P-24691/2	792040	792080
MIL-T-18165(old)	793040	793080
ASTM A335	791040	791080

STAINLESS	SCH 40	SCH 80	SCH 10	OD TUBE
MIL-P-24691/3				
MIL-P-1144(old)				
MIL-T-8504	304: 767040	767080	767010	767000
MIL-T-8506	316: 768040	768080	768010	768000
ASTM A312				
ASTM A376				

ALUMINUM				
6061	762040	762080	762010	762000
5086	764040	764080	764010	764000

MONEL NICKEL-COPPER				
MIL-T-1368	769040	769080	769010	769000
ASTM B165	769040	769080	769010	769000

RED BRASS*		
ASTM B43	741040	741080

COPPER*		
ASTM B42	751040	751080
ASTM B88 Tube	see page	111

*Note - Red brass and copper pipe walls are slightly different from above chart. See pg 110 for accurate walls for these items.

Also Available:

- Sch 5
- Sch 20
- Sch 30
- Sch 60
- Sch 120
- Sch 160
- XXH

TUBING CHART

TUBE OD SIZE	COMMON WALL THICKNESS				
1/8	.028	.035			
1/4	.028	.035	.049		
5/16	.028	.035	.049		
3/8	.028	.035	.049		
1/2	.028	.035	.049	.065	
5/8	.028	.035	.049	.065	.083
3/4	.028	.035	.049	.065	.083
7/8		.035	.049	.065	
1		.035	.049	.065	.083

DECK SLEEVES

DWGS 1385866, 2145801, 1856518

SIZES: 1/4" to 12"

Steel deck and bulkhead sleeves are available for steel or coppernickel piping systems. Standard sleeve length is 3 1/4" though longer sleeves are available.

DWG 2424406

SIZES: 1/4" to 8"

Steel deck sleeves straight and swaged type

DWG 2424424

SIZES: 1-1/2" to 10"

Steel insulated type deck sleeves with rubber cap

ALUMINUM & STEEL "CBC" TYPE STUFFING BOX RUBBER SEAL GASKET

DWG 545-1856518

SIZES: 1/4" TO 4"

Single Style: Nut and gasket one end only or

Double Style: Both ends

Aluminum	Single	549995
	Double	549996
Steel	Single	549997
	Double	549998

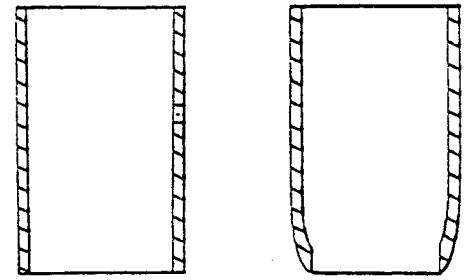

Straight

Swaged

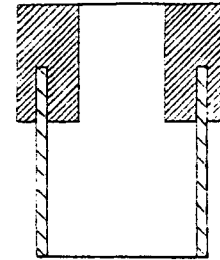

Insulated

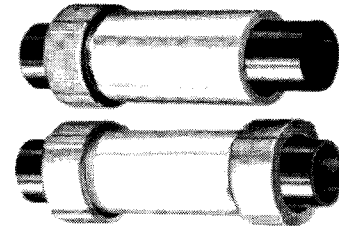

Single

Double

BACKING RINGS

MIL-STD-22D AND COMMERCIAL

	MIL	COMM
Steel STD	549985	549980
Steel XH	549986	549981
90/10 CL 200	549991	549990
70/30 CL 200	549993	549992
Stainless SCH 10	—	549971
SCH 40	—	549974
Monel SCH 40	—	549944

PIPE HANGERS AND CLAMPS

DWG 1385781 Types 1-10

Steel and Stainless Steel

Wider assortment of general commercial types: pg 116

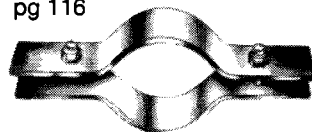

Riser Type
Dwg 1385781

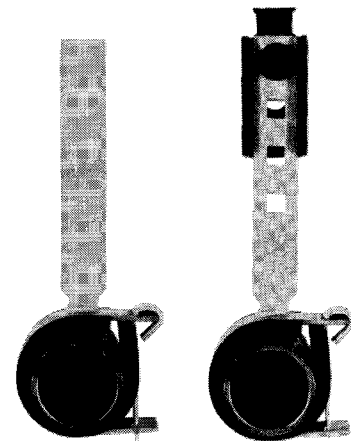

Nelson® Type - Weld & Stud
Pro-Loc® Type - similar not shown

COPPERNICKEL AND COPPER PIPE AND TUBING

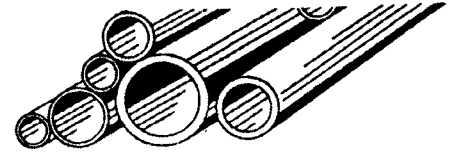

Thin and heavy wall tubing with pipe-size O.D.'s for use with silbraz, butt weld and socket weld fittings. Not for use with solder joint fittings due to different O.D.'s.

90/10 COPPER NICKEL:

MIL-T-16420 ALLOY 706 ANNEALED

Class 200	1/8" to 12"	710200
Class 50	12" to 24"	710050

MIL-T-15005 CONDENSER TUBE

3/8" O.D. to 3/4" O.D.	710000
------------------------	--------

ASTM B-466

Sch 40	1/4" to 8"	710040
Sch 80	1/4" to 6"	710080

70/30 COPPER NICKEL:

MIL-T-16420 ALLOY 715 ANNEALED

Class 200	1/8" to 24"	720200
Class 700	1/4" to 12"	720700
Class 1650	1/4" to 5"	721650
Class 3300	1/8" to 3"	723300
Class 6000	1/8" to 2"	726000

MIL-T-15005 CONDENSER TUBE

3/8" O.D. to 3/4" O.D.	720000
------------------------	--------

ASTM B-466

Sch 40	1/4" to 8"	720040
Sch 80	1/4" to 6"	720080

HARD DRAWN COPPER-DEOXIDIZED:

MIL-T-24107 ALLOY 122

Standard thin wall	1/8" to 10"	731000
Heavy wall	1/8" to 10"	731001

COPPERNICKEL

SIZE	OD	90/10		70/30			
		CL 50 Wall	CL 200 Wall	CL 700 Wall	1650 Wall	3300 Wall	6000 Wall
1/4 OD	.250		.035			.035	.058
1/8	.405					.058	.095
1/4	.540		.065	.065	.042	.072	.120
3/8	.675		.065	.072	.049	.095	.148
1/2	.840		.065	.072	.058	.120	.203
3/4	1.050		.065	.083	.083	.148	.238
1	1.315		.065	.095	.095	.180	.300
1 1/4	1.660		.072	.095	.120	.220	.380
1 1/2	1.900		.072	.109	.134	.250	.425
2	2.375		.083	.120	.165	.340	.520
2 1/2	2.875		.083	.134	.203	.380	
3	3.500		.095	.165	.250	.457	
3 1/2	4.000		.095	.180	.284		
4	4.500		.109	.203	.340		
4 1/2	5.000		.109				
5	5.563		.125	.220	.425		
6	6.625		.134	.259			
7	7.625		.140	.284			
8	8.625		.151	.340			
9	9.625		.187	.340			
10	10.75	.134	.187	.380			
11	11.75						
12	12.75	.156	.250	.454			
14	14.00	.165					
16	16.00	.165					
18	18.00	.180					
20	20.00	.180					

DEOXIDIZED COPPER

SIZE	OD	STD WALL		HEAVY WALLS			
		WALL	WALL	WALL	WALL	WALL	WALL
1/4 OD	.250	.032					
1/8	.405	.065	.083	.109			
1/4	.540	.065	.072	.109	.134		
3/8	.675	.065	.095	.134	.165		
1/2	.840	.065	.083	.120	.165	.220	
3/4	1.050	.065	.095	.148	.203	.263	
1	1.315	.065	.120	.180	.259	.340	
1 1/4	1.660	.065	.072	.084	.148	.220	.340
1 1/2	1.400	.065	.096	.180	.259	.380	
2	2.375	.085	.083	.109	.120	.220	.340
2 1/2	2.875	.065	.100	.130	.145	.259	.380
3	3.500	.065	.083	.122	.165	.177	.340
3 1/2	4.000	.065	.095	.140	.202		
4	4.500	.065	.107	.157	.228		
4 1/2	5.000	.065	.119	.174			
5	5.563	.068	.132	.194	.281		
6	6.625	.081	.158	.231	.335		
7	7.625	.093	.182	.266			
8	8.625	.105	.205	.301	.463		
9	9.625	.117	.229	.338			
10	10.75	.131	.256	.375	.544		

NOTES

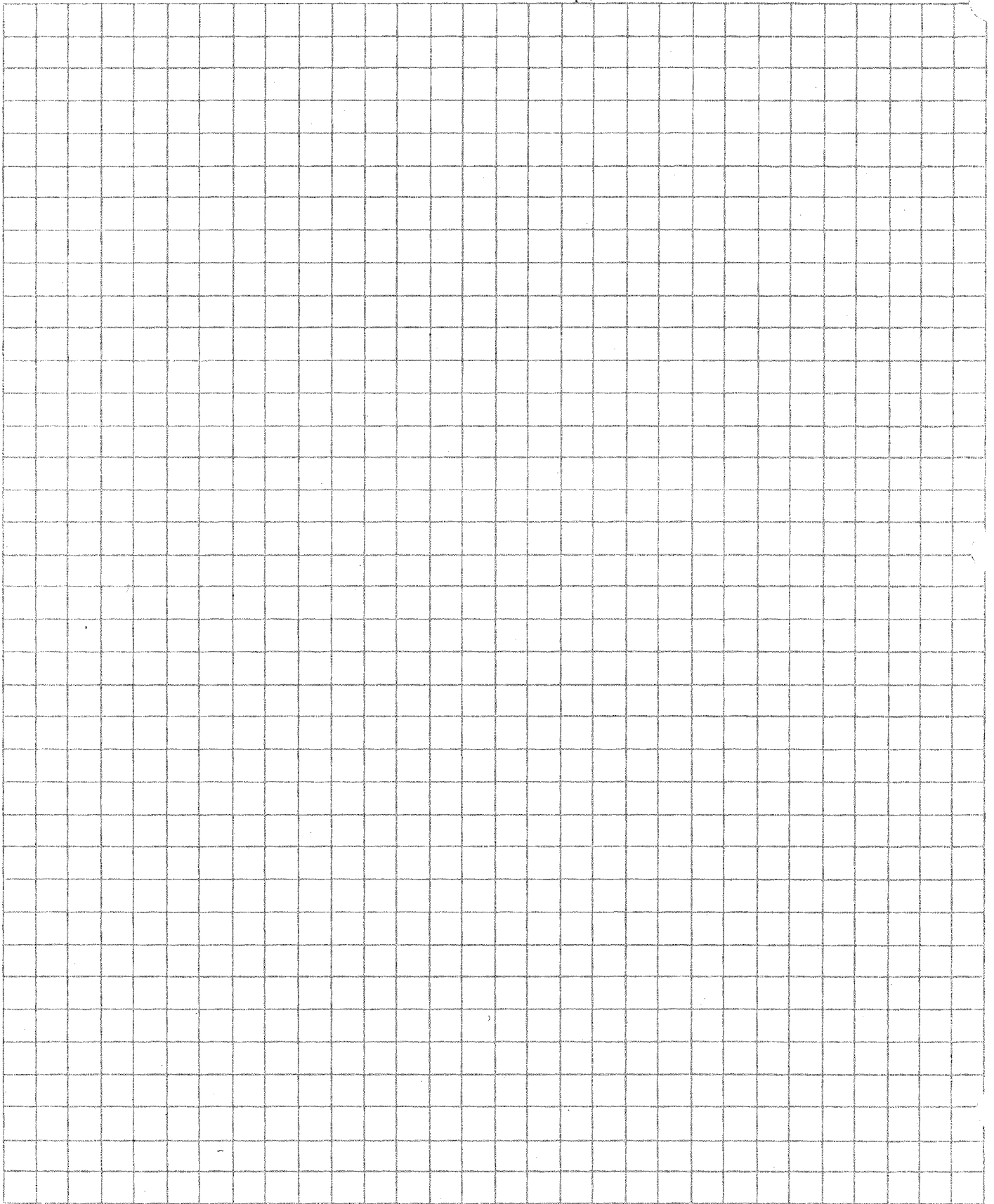



DETAILS OF MAINMAST HEAD, SHIP OF THE LINE, 1750

- | | | | | |
|------------------|-------------------|----------------------------|------------------------|-----------------------|
| 1 Mainmast | 5 Heel of topmast | 9 Parrel tackle | 13 Foretock shrouds | 17 Main footropes |
| 2 Trestle trees | 6 Main cap | 10 Main rigging or shrouds | 14 Topmast shrouds | 18 Main clew-garnet |
| 3 Mainsop | 7 Mainyard | 11 Mainsay- | 15 Mizzen topmast stay | 19 Main topsail sheet |
| 4 Lower masthead | 8 Main parrel | 12 Spring stay | 16 Main lift | 20 Main jibs |

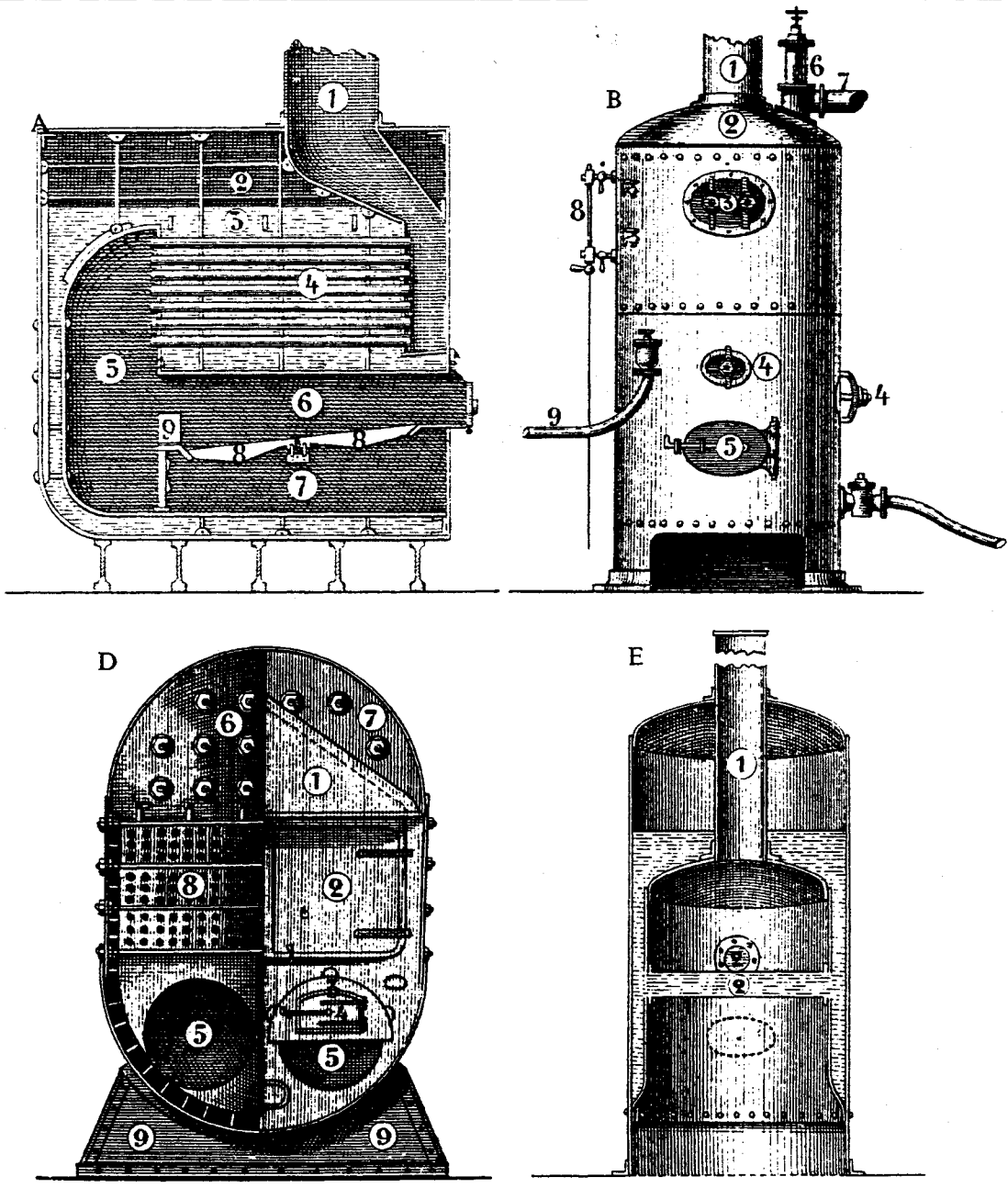

VARIOUS TYPES OF OLDER BOILERS

A Rectangular or box boiler

- 1 Uptake
- 2 Steam space
- 3 Water level
- 4 Boiler tubes
- 5 Combustion chamber
- 6 Furnace
- 7 Ash pit
- 8 Furnace bars
- 9 Furnace bridge

B Vertical donkey boiler

- 1 Donkey funnel
- 2 Crown of donkey boiler
- 3 Manhole door
- 4 Sludge hole doors
- 5 Furnace door
- 6 Safety valve
- 7 Steam pipe
- 8 Gauge glass
- 9 Feed pipe

D Oval donkey boiler

- 1 Uptake and smoke box
- 2 Smoke box door
- 3 Furnace front
- 4 Furnace door
- 5 Furnace and ash pit
- 6 Back plate
- 7 Front plate
- 8 Back tube-plate
- 9 Boiler bearer

E Water tube donkey boiler

- 1 Funnel
- 2 Water tubes

PROPERTIES OF WELDED AND SEAMLESS PIPE

Conforming to ANSI B36.10 for Wrought Steel and Wrought Iron Pipe and to ANSI B36.19 for Stainless Steel Pipe

Nominal Pipe Size Inches	Outside Diameter Inches	Wall Thickness Inches	Identification		Weight of Pipe Lb/Ft	Inside Diameter Inches	Area of Metal Sq. In.	Internal Cross-Sectional Area	
			Schedule Number	Designation				Sq. In.	Sq. Ft.
1/8	0.405	0.049	10S		0.19	0.307	0.055	0.0739	0.0005
		0.068	40, 40S	STD	0.24	0.269	0.072	0.0567	0.0003
		0.095	80, 80S	XS	0.31	0.215	0.092	0.0362	0.0002
1/4	0.540	0.065	10S		0.33	0.410	0.097	0.1320	0.0009
		0.088	40, 40S	STD	0.42	0.364	0.125	0.1039	0.0007
		0.119	80, 80S	XS	0.54	0.302	0.157	0.0716	0.0004
3/8	0.675	0.065	10S		0.42	0.545	0.124	0.2332	0.0016
		0.091	40, 40S	STD	0.57	0.493	0.167	0.1908	0.0013
		0.126	80, 80S	XS	0.74	0.423	0.217	0.1405	0.0009
1/2	0.840	0.065	5S		0.54	0.710	0.158	0.3959	0.0027
		0.083	10S		0.67	0.674	0.197	0.3567	0.0024
		0.109	40, 40S	STD	0.85	0.622	0.250	0.3037	0.0021
		0.147	80, 80S	XS	1.09	0.546	0.320	0.2341	0.0016
		0.188	160		1.31	0.464	0.385	0.1690	0.0011
		0.294		XSS	1.71	0.252	0.504	0.0498	0.0003
3/4	1.050	0.065	5S		0.69	0.920	0.201	0.6647	0.0046
		0.083	10S		0.86	0.884	0.252	0.6137	0.0042
		0.113	40, 40S	STD	1.13	0.824	0.332	0.5332	0.0037
		0.154	80, 80S	XS	1.47	0.742	0.433	0.4323	0.0030
		0.219	160		1.94	0.612	0.571	0.2941	0.0020
		0.308		XXS	2.44	0.434	0.718	0.1478	0.0010
1	1.315	0.065	5S		0.87	1.185	0.255	1.1028	0.0076
		0.109	10S		1.40	1.097	0.413	0.9451	0.0065
		0.133	40, 40S	STD	1.68	1.049	0.494	0.8642	0.0060
		0.179	80, 80S	XS	2.17	0.957	0.638	0.7192	0.0049
		0.250	160		2.84	0.815	1.836	0.5216	0.0036
		0.358		XXS	3.66	0.599	1.076	0.2818	0.0019
1 1/4	1.660	0.065	5S		1.11	1.530	0.326	1.8385	0.0127
		0.109	10S		1.81	1.442	0.531	1.6330	0.0113
		0.140	40, 40S	STD	2.27	1.380	0.668	1.4957	0.0103
		0.191	80, 80S	XS	3.00	1.278	0.881	1.2827	0.0089
		0.250	160		3.76	1.160	1.107	1.0568	0.0073
		0.382		XXS	5.21	0.896	1.533	0.6305	0.0043
1 1/2	1.900	0.065	5S		1.28	1.770	0.374	2.4605	0.0170
		0.109	10S		2.09	1.682	0.613	2.2219	0.0154
		0.145	40, 40S	STD	2.72	1.610	0.799	2.0358	0.0141
		0.200	80, 80S	XS	3.63	1.500	1.068	1.7671	0.0122
		0.281	160		4.86	1.338	1.438	1.4060	0.0097
		0.400		XSS	6.41	1.100	1.884	0.9503	0.0065
2	2.375	0.065	5S		1.61	2.245	0.471	3.9584	0.0274
		0.109	10S		2.64	2.157	0.776	3.6541	0.0253
		0.154	40, 40S	STD	3.65	2.067	1.074	3.3555	0.0233
		0.218	80, 80S	XS	5.02	1.939	1.476	2.9528	0.0205
		0.344	160		7.46	1.687	2.194	2.2351	0.0155
		0.436		XXS	9.03	1.503	2.655	1.7742	0.0123
2 1/2	2.875	0.083	5S		2.48	2.709	0.728	5.7637	0.0400
		0.120	10S		3.53	2.635	1.038	5.4531	0.0378
		0.203	40, 40S	STD	5.79	2.469	1.703	4.7877	0.0332
		0.276	80, 80S	XS	7.66	2.323	2.252	4.2382	0.0294
		0.375	160		10.01	2.125	2.944	3.5465	0.0246
		0.552		XXS	13.69	1.771	4.026	2.4633	0.0171
3	3.500	0.083	5S		3.03	3.334	0.890	8.7301	0.0606
		0.120	10S		4.33	3.260	1.274	8.3469	0.0579
		0.210	40, 40S	STD	7.58	3.068	2.227	7.3926	0.0513
		0.300	80, 80S	XS	10.25	2.900	3.014	6.6052	0.0458
		0.438	160		14.32	2.624	4.211	5.4077	0.0375
		0.600		XXS	18.58	2.300	5.464	4.1547	0.0288
3 1/2*	4.000	0.083	5S		3.92	4.334	1.151	14.7525	0.1024
		0.120	10S		5.61	4.260	1.650	14.2531	0.0989
		0.237	40, 40S	STD	10.79	4.026	3.172	12.7302	0.0884
4	4.500	0.337	80, 80S	XS	14.98	3.826	4.405	11.4968	0.0798
		0.438	120		19.00	3.624	5.587	10.3148	0.0716
		0.531	160		22.51	3.438	6.618	9.2832	0.0644
		0.674		XXS	27.54	3.152	8.097	7.8030	0.0541
		0.109	5S		6.36	5.345	1.868	22.438	0.1558
		0.134	10S		7.77	5.295	2.285	22.020	0.1529
5	5.563	0.258	40, 40S	STD	14.62	5.047	4.300	22.006	0.1389
		0.375	80, 80S	XS	20.78	4.813	6.112	18.194	0.1283
		0.500	120		27.04	4.563	7.953	16.353	0.1135
		0.625	160		32.96	4.313	9.696	14.610	0.1014
		0.750		XXS	38.55	4.063	11.340	12.965	0.0900
		0.109	5S		7.59	6.407	2.231	32.240	0.2238
6	6.625	0.134	10S		9.29	6.357	2.732	31.739	0.2204
		0.280	40, 40S	STD	18.97	6.065	5.581	28.890	0.2006
		0.432	80, 80S	XS	28.57	5.761	8.405	26.067	0.1810
		0.562	120		36.39	5.501	10.705	23.767	0.1650
		0.719	160		45.35	5.187	13.340	21.131	0.1467
		0.864		XXS	53.16	4.897	15.637	18.834	0.1307
8	8.625	0.109	5S		9.93	8.407	2.916	55.510	0.3854
		0.148	10S		13.40	8.329	3.941	54.485	0.3783
		0.250	20		22.36	8.125	6.578	51.849	0.3600
		0.277	30		24.70	8.071	7.265	51.162	0.3552
		0.322	40, 40S	STD	28.55	7.981	8.399	50.027	0.3474
		0.406	60		35.64	7.813	10.483	47.943	0.3329
		0.500	80, 80S	XS	43.39	7.625	12.763	45.664	0.3171
		0.594	100		50.95	7.437	14.987	43.440	0.3016
		0.719	120		60.71	7.187	17.858	40.568	0.2817
		0.812	140		67.76	7.001	19.931	38.496	0.2673
		0.875		XXS	72.42	6.875	21.304	37.122	0.2577
		0.906	160		74.69	6.813	21.970	36.456	0.2531
3 1/2*		SCH 10	0.120	STD	0.226	XH	0.318	XXS	0.636

PROPERTIES OF WELDED AND SEAMLESS PIPE

Conforming to ANSI B36.10 for Wrought Steel and Wrought Iron Pipe and to ANSI B36.19 for Stainless Steel Pipe

Nominal Pipe Size Inches	Outside Diameter Inches	Wall Thickness Inches	Identification		Weight of Pipe Lb/Ft	Inside Diameter Inches	Area of Metal Sq. In.	Internal Cross-Sectional Area	
			Schedule Number	Designation				Sq. In.	Sq. Ft.*
10	10.750	0.134	5S		15.19	10.482	4.469	86.294	0.5992
		0.165	10S		18.65	10.420	5.487	85.276	0.5921
		0.250	20		28.04	10.250	8.247	82.516	0.5730
		0.307	30		34.24	10.136	10.072	80.691	0.5603
		0.365	40, 40S	STD	40.48	10.020	11.908	78.854	0.5476
		0.500	60, 80S	XS	54.74	9.750	16.101	74.662	0.5184
		0.594	80		64.43	9.562	18.952	71.811	0.4986
		0.719	100		77.03	9.312	22.658	68.105	0.4729
		0.844	120		89.29	9.062	26.266	64.497	0.4478
		1.000	140	XXS	104.13	8.750	30.631	60.132	0.4175
		1.125	160		115.64	8.500	34.018	56.745	0.3940
		12	12.750	0.156	5S		20.98	12.438	6.172
0.180	10S				24.17	12.390	7.108	120.568	0.8372
0.250	20				33.38	12.250	9.818	117.859	0.8184
0.330	30				43.77	12.090	12.876	114.800	0.7972
0.375	40S			STD	49.56	12.000	14.579	113.098	0.7854
0.406	40				53.52	11.938	15.745	111.932	0.7773
0.500	80S			XS	65.42	11.750	19.242	108.434	0.7530
0.562	60				73.15	11.625	21.519	106.158	0.7372
0.688	80				88.63	11.375	26.071	101.605	0.7055
0.844	100				107.32	11.062	31.569	96.107	0.6674
1.000	120			XXS	125.49	10.750	36.914	90.763	0.6302
1.125	140				139.67	10.500	41.086	86.590	0.6013
1.312	160		160.27	10.126	47.145	80.532	0.5592		
14	14.000	0.156	5S		23.07	13.688	6.785	147.154	1.0218
		0.188	10S		27.73	13.624	8.158	145.781	1.0123
		0.250	20		36.71	13.500	10.799	143.140	0.9940
		0.312	30		45.61	13.375	13.417	140.522	0.9758
		0.375	40	STD	54.57	13.250	16.052	137.887	0.9575
		0.438	40		63.44	13.125	18.662	135.297	0.9394
		0.500	60	XS	72.09	13.000	21.206	132.733	0.9217
		0.594	80		85.05	12.812	25.017	128.921	0.8952
		0.750	100		106.13	12.500	31.220	122.719	0.8522
		0.938	120		130.85	12.124	38.491	115.447	0.8017
		1.094	140		150.79	11.812	44.357	109.581	0.7609
		1.250	160		170.21	11.500	50.069	103.869	0.7213
1.406	180		189.11	11.188	55.629	98.309	0.6827		
16	16.000	0.165	5S		27.90	15.670	8.208	192.854	1.339
		0.188	10S		31.75	15.624	9.338	191.723	1.331
		0.250	20		42.05	15.500	12.370	188.692	1.310
		0.312	30		52.27	15.376	15.377	185.685	1.289
		0.375	40	STD	62.58	15.250	18.407	182.654	1.268
		0.500	60	XS	82.77	15.000	24.347	176.715	1.227
		0.656	80		107.50	14.688	31.622	169.440	1.176
		0.844	100		136.61	14.312	40.186	160.876	1.117
		1.031	120		164.82	13.938	48.484	152.577	1.059
		1.219	140		192.43	13.562	56.605	144.456	1.003
		1.438	160		223.64	13.124	65.785	135.276	0.939
		1.594	180		245.25	12.612	72.141	128.921	0.895
18	18.000	0.165	5S		31.43	17.670	9.245	245.224	1.702
		0.188	10S		35.76	17.624	10.520	243.949	1.694
		0.250	20		47.39	17.500	13.940	240.528	1.670
		0.312	30		58.94	17.376	17.337	237.132	1.646
		0.375	40	STD	70.59	17.250	20.764	233.705	1.622
		0.438	40		82.15	17.124	24.165	230.303	1.599
		0.500	60	XS	93.45	17.000	27.489	226.980	1.576
		0.562	80		104.67	16.876	30.788	223.681	1.553
		0.750	100		138.17	16.500	40.644	213.825	1.484
		0.938	120		170.92	16.124	50.278	204.190	1.417
		1.156	140		207.96	15.688	61.172	193.297	1.342
		1.375	160		244.14	15.250	71.815	182.654	1.268
20	20.000	0.188	5S		39.78	19.624	11.701	302.458	2.100
		0.218	10S		46.06	19.564	13.548	300.611	2.087
		0.250	20		52.73	19.500	15.511	298.648	2.073
		0.375	30	STD	78.60	19.250	23.120	291.039	2.021
		0.500	40	XS	104.13	19.000	30.630	283.529	1.968
		0.594	60		123.11	18.812	36.213	277.946	1.930
		0.812	80		166.40	18.376	48.948	265.211	1.841
		1.031	100		208.87	17.938	61.440	252.719	1.754
		1.281	120		256.10	17.438	75.332	238.827	1.658
		1.500	140		296.37	17.000	87.179	226.980	1.576
		1.750	160		341.09	16.500	100.334	213.825	1.484
		1.969	180		379.17	16.062	111.536	202.623	1.407
24	24.000	0.218	5S		55.37	23.564	16.287	436.102	3.028
		0.250	10, 10S		63.41	23.500	18.653	433.737	3.012
		0.375	20	STD	94.62	23.250	27.832	424.557	2.948
		0.500	30	XS	125.49	23.000	36.913	415.476	2.885
		0.562	40		140.68	22.876	41.381	411.008	2.854
		0.688	60		171.29	22.624	50.387	402.003	2.791
		0.969	80		238.35	22.062	70.111	382.279	2.654
		1.219	100		296.58	21.562	87.242	365.148	2.535
		1.531	120		367.39	20.938	108.071	344.319	2.391
		1.812	140		429.39	20.376	126.307	326.083	2.264
		2.062	160		483.12	19.876	142.113	310.276	2.154
		2.344	180		542.13	19.312	159.472	292.917	2.034
30	30.000	0.250	5S		79.43	29.500	23.365	683.494	4.746
		0.312	10, 10S		98.93	29.376	29.099	677.760	4.706
		0.375	20	STD	118.65	29.250	34.901	671.958	4.666
		0.500	30	XS	157.53	29.000	46.338	660.521	4.586
		0.625	40		196.08	28.750	57.677	649.182	4.508
		0.312	10	STD	118.92	35.376	34.980	982.897	6.825
36	36.000	0.375	20	XS	142.68	35.250	41.969	975.908	6.777
		0.500	30		189.57	35.000	55.763	962.115	6.681
		0.625	40		236.13	34.750	69.458	948.419	6.586
		0.750	60		282.35	34.500	83.056	934.822	6.491

*This column also represents the contents in cubic feet per foot of length.

BRONZE FLANGE DIMENSIONS

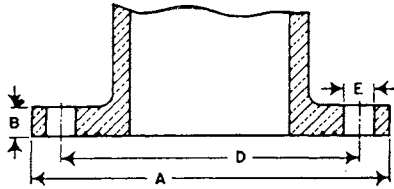

Class 150 and Class 300 Bronze

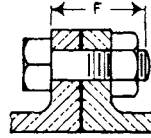

Length of Machine Bolt

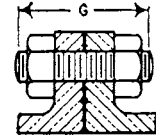

Length of Stud Bolt

CLASS 150 BRONZE FLANGES

Dimensions in Inches

Nominal Pipe Size	Flanges		Drilling		Bolting		Length of Machine Bolts F	Length of Stud Bolts with 2 Nuts G
	Flange Diameter A	Flange Thickness B	Diameter of Bolt Circle D	Diameter of Bolt Holes E	Number of Bolts	Diameter of Bolts		
1/2	3 1/2	5/16	2 3/8	5/8	4	1/2	1 1/4	1 7/8
3/4	3 3/8	1 1/32	2 3/4	5/8	4	1/2	1 1/2	1 7/8
1	4 1/4	3/8	3 3/8	5/8	4	1/2	1 1/2	2
1 1/4	4 5/8	1 3/32	3 1/2	5/8	4	1/2	1 1/2	2
1 1/2	5	7/16	3 7/8	5/8	4	1/2	1 1/2	2 1/8
2	6	1/2	4 3/4	3/4	4	5/8	1 3/4	2 1/2
2 1/2	7	9/16	5 1/2	3/4	4	5/8	2	2 5/8
3	7 1/2	5/8	6	3/4	4	5/8	2	2 3/4
3 1/2	8 1/2	1 1/16	7	3/4	8	5/8	2 1/4	2 7/8
4	9	1 1/16	7 1/2	3/4	8	5/8	2 1/4	2 7/8
5	10	3/4	8 1/2	7/8	8	3/4	2 1/2	3 1/4
6	11	1 3/16	9 1/2	7/8	8	3/4	2 1/2	3 3/8
8	13 1/2	1 5/16	11 3/4	7/8	8	3/4	2 3/4	3 5/8
10	16	1	14 1/4	1	12	7/8	3 1/4	4 1/8
12	19	1 1/16	17	1	12	7/8	3 1/4	4 1/4

CLASS 300 BRONZE FLANGES

Nominal Pipe Size	Flanges		Drilling		Bolting		Length of Machine Bolts F	Length of Stud Bolts with 2 Nuts G
	Flange Diameter A	Flange Thickness B	Diameter of Bolt Circle D	Diameter of Bolt Holes E	Number of Bolts	Diameter of Bolts		
1/2	3 3/4	1/2	2 5/8	5/8	4	1/2	1 3/4	2 1/4
3/4	4 5/8	1 7/32	3 1/4	3/4	4	5/8	2	2 1/2
1	4 7/8	1 9/32	3 1/2	3/4	4	5/8	2	2 5/8
1 1/4	5 1/4	5/8	3 7/8	3/4	4	5/8	2	2 3/4
1 1/2	6 1/8	1 1/16	4 1/2	7/8	4	3/4	2 1/4	3 1/8
2	6 1/2	3/4	5	3/4	8	5/8	2 1/4	3
2 1/2	7 1/2	1 3/16	5 7/8	7/8	8	3/4	2 1/2	3 3/8
3	8 1/4	2 9/32	6 5/8	7/8	8	3/4	2 3/4	3 1/2
3 1/2	9	3 1/32	7 1/4	7/8	8	3/4	3	3 5/8
4	10	1 1/16	7 7/8	7/8	8	3/4	3	3 7/8
5	11	1 1/8	9 1/4	7/8	8	3/4	3 1/4	4
6	12 1/2	1 3/16	10 5/8	7/8	12	3/4	3 1/4	4 1/8
8	15	1 3/8	13	1	12	7/8	3 3/4	4 3/4
10	17 1/2	1 7/16	15 1/4	1 1/8	16	1	4 1/4	5 1/4
12	20 1/2	1 7 17/32	17 3/4	1 1/4	16	1 1/8	4 1/2	5 3/4

When flanges are integral with valves or fittings, the bolt holes, which are in multiples of four, are drilled to straddle the center lines unless otherwise ordered. Full face gaskets extending to the flange edge as given in ANSI Standard Nonmetallic Gaskets to Pipe Flanges (ANSI B16.21) are required. Metallic gaskets should not be used.

Flanges are smooth finished over the entire face and are provided with two concentric gasket retaining grooves inside the bolt holes. When bronze flanges are bolted to cast iron or steel flanges which normally have a raised face, the raised face should be removed. See page E26.

Flange diameters and drilling templates of 150 lb bronze flanges are the same as corresponding sizes of the ANSI 125 lb Cast Iron Flange Standard, ANSI B16.1 and the ANSI Class 150 Steel Flange Standard, ANSI B16.5. The Class 300 bronze flange diameters and drilling templates are the same as corresponding sizes of the ANSI Class 250 Cast Iron Flange Standard, ANSI B16.1 and the ANSI Class 300 Steel Flange Standard, ANSI B16.5.

CAST IRON FLANGE DIMENSIONS

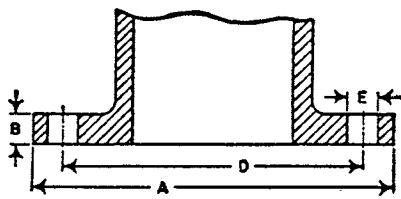

Class 125 Cast Iron

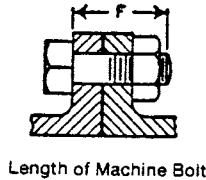

Length of Machine Bolt

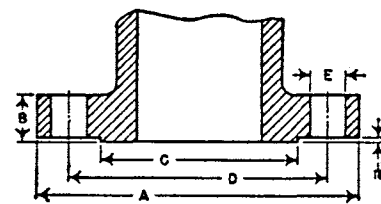

Class 250 Cast Iron

CLASS 125 CAST IRON FLANGES

Dimensions in Inches

Nominal Pipe Size	Flanges		Drilling		Bolting		Length of Machine Bolts F
	Flange Diameter A	Flange Thickness B	Diameter of Bolt Circle D	Diameter of Bolt Holes E	Number of Bolts	Diameter of Bolts	
1	4 $\frac{1}{4}$	7 $\frac{1}{16}$	3 $\frac{3}{8}$	$\frac{5}{8}$	4	$\frac{1}{2}$	1 $\frac{3}{4}$
1 $\frac{1}{4}$	4 $\frac{5}{8}$	$\frac{1}{2}$	3 $\frac{1}{2}$	$\frac{5}{8}$	4	$\frac{1}{2}$	2
1 $\frac{1}{2}$	5	9 $\frac{1}{16}$	3 $\frac{7}{8}$	$\frac{5}{8}$	4	$\frac{1}{2}$	2
2	6	$\frac{5}{8}$	4 $\frac{3}{4}$	$\frac{3}{4}$	4	$\frac{5}{8}$	2 $\frac{1}{4}$
2 $\frac{1}{2}$	7	1 $\frac{1}{16}$	5 $\frac{1}{2}$	$\frac{3}{4}$	4	$\frac{5}{8}$	2 $\frac{1}{2}$
3	7 $\frac{1}{2}$	$\frac{3}{4}$	6	$\frac{3}{4}$	4	$\frac{5}{8}$	2 $\frac{1}{2}$
3 $\frac{1}{2}$	8 $\frac{1}{2}$	$\frac{13}{16}$	7	$\frac{3}{4}$	8	$\frac{3}{8}$	3
4	9	1 $\frac{5}{16}$	7 $\frac{1}{2}$	$\frac{3}{4}$	8	$\frac{5}{8}$	3
5	10	1 $\frac{5}{16}$	8 $\frac{1}{2}$	$\frac{7}{8}$	8	$\frac{3}{4}$	3
6	11	1	9 $\frac{1}{2}$	$\frac{7}{8}$	8	$\frac{3}{4}$	3 $\frac{1}{4}$
8	13 $\frac{1}{2}$	1 $\frac{1}{8}$	11 $\frac{3}{4}$	$\frac{7}{8}$	8	$\frac{3}{4}$	3 $\frac{1}{2}$
10	16	1 $\frac{3}{16}$	14 $\frac{1}{4}$	1	12	$\frac{7}{8}$	3 $\frac{3}{4}$
12	19	1 $\frac{1}{4}$	17	1	12	$\frac{7}{8}$	3 $\frac{3}{4}$
14	21	1 $\frac{3}{8}$	18 $\frac{3}{4}$	1 $\frac{1}{8}$	12	1	4 $\frac{1}{4}$
16	23 $\frac{1}{2}$	1 $\frac{7}{16}$	21 $\frac{1}{4}$	1 $\frac{1}{8}$	16	1	4 $\frac{1}{2}$
18	25	1 $\frac{9}{16}$	22 $\frac{3}{4}$	1 $\frac{1}{4}$	16	1 $\frac{1}{8}$	4 $\frac{3}{4}$
20	27 $\frac{1}{2}$	1 $\frac{11}{16}$	25	1 $\frac{1}{4}$	20	1 $\frac{1}{8}$	5
24	32	1 $\frac{7}{8}$	29 $\frac{1}{2}$	1 $\frac{3}{8}$	20	1 $\frac{1}{4}$	5 $\frac{1}{2}$
30	38 $\frac{3}{4}$	2 $\frac{1}{8}$	36	1 $\frac{3}{8}$	28	1 $\frac{1}{4}$	6 $\frac{1}{4}$
36	46	2 $\frac{3}{8}$	42 $\frac{3}{4}$	1 $\frac{5}{8}$	32	1 $\frac{1}{2}$	7

Bolt lengths are for flanges of thickness shown herein. Bolt lengths should be checked for the thicker flanges shown in some individual valve description pages.

When flanges are integral with valves or fittings, the bolt holes, which are in multiples of four, are drilled to straddle the center lines unless otherwise ordered. Class 125 cast iron flanges have plain faces.

CLASS 250

Nominal Pipe Size	Flanges		Drilling			Bolting		Length of Machine Bolts F
	Flange Diameter A	Flange Thickness B	Diameter of Raised Face C	Diameter of Bolt Circle D	Diameter of Bolt Holes E	Number of Bolts	Diameter of Bolts	
1	4 $\frac{7}{8}$	1 $\frac{1}{16}$	2 $\frac{11}{16}$	3 $\frac{1}{2}$	$\frac{3}{4}$	4	$\frac{5}{8}$	2 $\frac{1}{2}$
1 $\frac{1}{4}$	5 $\frac{1}{4}$	$\frac{3}{4}$	3 $\frac{1}{16}$	3 $\frac{7}{8}$	$\frac{3}{4}$	4	$\frac{5}{8}$	2 $\frac{1}{2}$
1 $\frac{1}{2}$	6 $\frac{1}{8}$	1 $\frac{3}{16}$	3 $\frac{9}{16}$	4 $\frac{1}{2}$	$\frac{7}{8}$	4	$\frac{3}{4}$	2 $\frac{3}{4}$
2	6 $\frac{1}{2}$	$\frac{7}{8}$	4 $\frac{3}{16}$	5	$\frac{3}{4}$	8	$\frac{5}{8}$	2 $\frac{3}{4}$
2 $\frac{1}{2}$	7 $\frac{1}{2}$	1	4 $\frac{15}{16}$	5 $\frac{7}{8}$	$\frac{7}{8}$	8	$\frac{3}{4}$	3 $\frac{1}{4}$
3	8 $\frac{1}{4}$	1 $\frac{1}{8}$	5 $\frac{11}{16}$	6 $\frac{5}{8}$	$\frac{7}{8}$	8	$\frac{3}{4}$	3 $\frac{1}{2}$
4	10	1 $\frac{1}{4}$	6 $\frac{9}{16}$	7 $\frac{7}{8}$	$\frac{7}{8}$	8	$\frac{3}{4}$	3 $\frac{3}{4}$
5	11	1 $\frac{3}{8}$	8 $\frac{5}{16}$	9 $\frac{1}{4}$	$\frac{7}{8}$	8	$\frac{3}{4}$	4
6	12 $\frac{1}{2}$	1 $\frac{7}{16}$	9 $\frac{11}{16}$	10 $\frac{3}{8}$	$\frac{7}{8}$	12	$\frac{3}{4}$	4
8	15	1 $\frac{5}{8}$	11 $\frac{15}{16}$	13	1	12	$\frac{7}{8}$	4 $\frac{1}{2}$
10	17 $\frac{1}{2}$	1 $\frac{7}{8}$	14 $\frac{1}{16}$	15 $\frac{1}{4}$	1 $\frac{1}{8}$	16	1	5 $\frac{1}{4}$
12	20 $\frac{1}{2}$	2	16 $\frac{7}{16}$	17 $\frac{3}{4}$	1 $\frac{1}{4}$	16	1 $\frac{1}{8}$	5 $\frac{1}{2}$
14	23	2 $\frac{1}{8}$	18 $\frac{15}{16}$	20 $\frac{1}{4}$	1 $\frac{1}{4}$	20	1 $\frac{1}{8}$	6
16	25 $\frac{1}{2}$	2 $\frac{1}{4}$	21 $\frac{11}{16}$	22 $\frac{1}{2}$	1 $\frac{3}{8}$	20	1 $\frac{1}{4}$	6 $\frac{1}{4}$
18	28	2 $\frac{3}{8}$	23 $\frac{9}{16}$	24 $\frac{3}{4}$	1 $\frac{3}{8}$	24	1 $\frac{1}{4}$	6 $\frac{1}{2}$
20	30 $\frac{1}{2}$	2 $\frac{1}{2}$	25 $\frac{9}{16}$	27	1 $\frac{3}{8}$	24	1 $\frac{1}{4}$	6 $\frac{3}{4}$
24	36	2 $\frac{3}{4}$	30 $\frac{9}{16}$	32	1 $\frac{5}{8}$	24	1 $\frac{1}{2}$	7 $\frac{1}{2}$

When Class 250 cast iron flanges are bolted to bronze flanges, the $\frac{1}{16}$ -inch raised face should be removed and a full-face gasket used.

The $\frac{1}{16}$ -inch raised face on the Class 250 cast iron flanges is included in the dimension B for thickness of flange.

Bolt lengths are for flanges of thickness shown herein. Bolt lengths should be checked for the thicker flanges shown in some individual valve description pages.

STEEL FLANGE DIMENSIONS

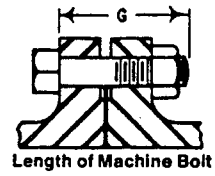
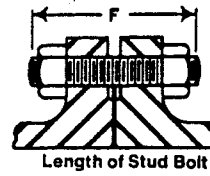
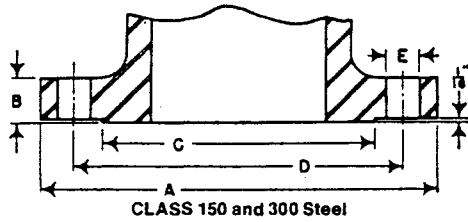

CLASS 150 STEEL FLANGES

Nominal Pipe Size	Flange Diameter A	Flange Thickness Companion Flange B	Valve Flange B	Diameter of Raised Face C	Diameter of Bolt Circle D	Diameter of Bolt Holes E	Number of Bolts	Diameter of Bolts	Length of Stud Bolts with 2 Nuts F	Length of Machine Bolts G
1/2	3 1/2	7/16	—	1 3/8	2 3/8	5/8	4	1/2	2 1/4	1 3/4
3/4	3 3/8	1/2	—	1 11/16	2 3/4	5/8	4	1/2	2 1/4	2
1	4 1/4	9/16	7/16	2	3 3/8	5/8	4	1/2	2 1/2	2
1 1/4	4 5/8	5/8	1/2	2 1/2	3 1/2	5/8	4	1/2	2 1/2	2 1/4
1 1/2	5	11/16	9/16	2 7/8	3 7/8	5/8	4	1/2	2 3/4	2 1/4
2	6	3/4	5/8	3 5/8	4 3/4	3/4	4	5/8	3	2 3/4
2 1/2	7	7/8	11/16	4 1/8	5 1/2	3/4	4	5/8	3 1/4	3
3	7 1/2	15/16	3/4	5	6	3/4	4	5/8	3 1/2	3
3 1/2	8 1/2	15/16	13/16	5 1/2	7	3/4	8	5/8	3 1/2	3
4	9	15/16	15/16	6 3/16	7 1/2	3/4	8	5/8	3 1/2	3
5	10	15/16	15/16	7 5/16	8 1/2	7/8	8	3/4	3 3/4	3 1/4
6	11	1	1	8 1/2	9 1/2	7/8	8	3/4	3 3/4	3 1/4
8	13 1/2	1 1/8	1 1/8	10 5/8	11 3/4	7/8	8	3/4	4	3 1/2
10	16	1 3/16	1 3/16	12 3/4	14 1/4	1	12	7/8	4 1/2	3 3/4
12	19	1 1/4	1 1/4	15	17	1	12	7/8	4 1/2	4
14	21	1 3/8	1 3/8	16 1/4	18 3/4	1 1/8	12	1	5	4 1/4
16	23 1/2	1 7/16	1 7/16	18 1/2	21 1/4	1 1/8	16	1	5 1/4	4 1/2
18	25	1 9/16	1 9/16	21	22 3/4	1 1/4	16	1 1/8	5 3/4	4 3/4
20	27 1/2	1 11/16	1 11/16	23	25	1 1/4	20	1 1/8	6	5 1/4
24	32	1 7/8	1 7/8	27 1/4	29 1/2	1 3/8	20	1 1/2	6 3/4	5 3/4

CLASS 300

Nominal Pipe Size	Flange Diameter A	Flange Thickness B	Diameter of Raised Face C	Diameter of Bolt Circle D	Diameter of Bolt Holes E	Number of Bolts	Diameter of Bolts	Length of Stud Bolts with 2 Nuts F	Length of Machine Bolts G
1/2	3 3/4	9/16	1 3/8	2 5/8	5/8	4	1/2	2 1/2	2
3/4	4 5/8	5/8	1 11/16	3 1/4	3/4	4	5/8	2 3/4	2 1/2
1	4 7/8	11/16	2	3 1/2	3/4	4	5/8	3	2 1/2
1 1/4	5 1/4	3/4	2 1/2	3 7/8	3/4	4	5/8	3	2 3/4
1 1/2	6 1/8	13/16	2 7/8	4 1/2	7/8	4	3/4	3 1/2	3
2	6 1/2	7/8	3 5/8	5	3/4	8	5/8	3 1/4	3
2 1/2	7 1/2	1	4 1/8	5 7/8	7/8	8	3/4	3 3/4	3 1/4
3	8 1/4	1 1/8	5	6 5/8	7/8	8	3/4	4	3 1/2
3 1/2	9	1 3/16	5 1/2	7 1/4	7/8	8	3/4	4 1/4	3 3/4
4	10	1 1/4	6 3/16	7 7/8	7/8	8	3/4	4 1/4	3 3/4
5	11	1 3/8	7 5/16	9 1/4	7/8	8	3/4	4 1/2	4
6	12 1/2	1 7/16	8 1/2	10 5/8	7/8	12	3/4	4 3/4	4 1/4
8	15	1 5/8	10 5/8	13	1	12	7/8	5 1/4	4 3/4
10	17 1/2	1 7/8	12 3/4	15 1/4	1 1/8	16	1	6	5 1/4
12	20 1/2	2	15	17 3/4	1 1/4	16	1 1/8	6 1/2	5 3/4
14	23	2 1/8	16 1/4	20 1/4	1 1/4	20	1 1/8	6 3/4	6
16	25 1/2	2 1/4	18 1/2	22 1/2	1 3/8	20	1 1/4	7 1/4	6 1/2
18	28	2 3/8	21	24 3/4	1 3/8	24	1 1/4	7 1/2	6 3/4
20	30 1/2	2 1/2	23	27	1 3/8	24	1 1/4	8	7
24	36	2 3/4	27 1/4	32	1 5/8	24	1 1/2	9	7 3/4

The regular 1/16-inch raised face of Class 150 and 300 flanges is included in the minimum flange thickness given above, but other raised faces must be added thereto.

Class 150 loose flanges are thicker than integral flanges for sizes 3 1/2-inch and smaller. Note column B.

Lengths of alloy steel stud bolts do not include the height of the points.

Bolt lengths not shown in the tables can be determined by reference to Appendix F of ANSI B16.5.

STEEL FLANGE DIMENSIONS

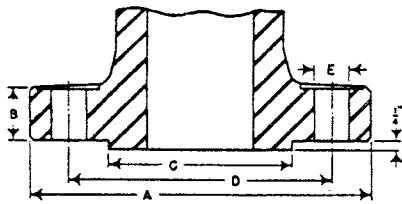

Class 400 and 600 Steel

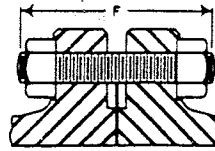

Male to Male
Flanged Joint

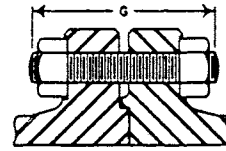

Male to Female
Flanged Joint

CLASS 400

Nominal Pipe Size	Flange Diameter A	Flange Thickness B	Diameter of Raised Face C	Diameter of Bolt Circle D	Diameter of Bolt Holes E	Number of Stud Bolts	Diameter of Stud Bolts	Length of Stud Bolts with 2 Nuts	
								F	G
4*	10	1 ³ / ₈	6 ³ / ₁₆	7 ⁷ / ₈	1	8	7 ⁷ / ₈	5 ¹ / ₄	5
5	11	1 ¹ / ₂	7 ⁵ / ₁₆	9 ¹ / ₄	1	8	7 ⁷ / ₈	5 ¹ / ₂	5 ¹ / ₄
6	12 ¹ / ₂	1 ⁵ / ₈	8 ¹ / ₂	10 ⁵ / ₈	1	12	7 ⁷ / ₈	5 ³ / ₄	5 ¹ / ₂
8	15	1 ⁷ / ₈	10 ⁵ / ₈	13	1 ¹ / ₈	12	1	6 ¹ / ₂	6 ¹ / ₄
10	17 ¹ / ₂	2 ¹ / ₈	12 ³ / ₄	15 ¹ / ₄	1 ¹ / ₄	16	1 ¹ / ₈	7 ¹ / ₄	7
12	20 ¹ / ₂	2 ¹ / ₄	15	17 ³ / ₄	1 ³ / ₈	16	1 ¹ / ₄	7 ³ / ₄	7 ¹ / ₂
14	23	2 ³ / ₈	16 ¹ / ₄	20 ¹ / ₄	1 ³ / ₈	20	1 ¹ / ₄	8	7 ³ / ₄
16	25 ¹ / ₂	2 ¹ / ₂	18 ¹ / ₂	22 ¹ / ₂	1 ¹ / ₂	20	1 ³ / ₈	8 ¹ / ₂	8 ¹ / ₄
18	28	2 ⁵ / ₈	21	24 ³ / ₄	1 ¹ / ₂	24	1 ³ / ₈	8 ³ / ₄	8 ¹ / ₂
20	30 ¹ / ₂	2 ³ / ₄	23	27	1 ⁵ / ₈	24	1 ¹ / ₂	9 ¹ / ₂	9 ¹ / ₄
24	36	3	27 ¹ / ₄	32	1 ⁷ / ₈	24	1 ³ / ₄	10 ¹ / ₂	10 ¹ / ₄

*Use Class 600 dimensions in sizes smaller than 4-inch.

CLASS 600

Nominal Pipe Size	Flange Diameter A	Flange Thickness B	Diameter of Raised Face C	Diameter of Bolt Circle D	Diameter of Bolt Holes E	Number of Stud Bolts	Diameter of Stud Bolts	Length of Stud Bolts with 2 Nuts	
								F	G
1/2	3 ³ / ₄	9 ¹ / ₁₆	1 ³ / ₈	2 ⁵ / ₈	5 ⁷ / ₈	4	1/2	3	2 ³ / ₄
3/4	4 ⁵ / ₈	5 ⁹ / ₁₆	1 ¹¹ / ₁₆	3 ¹ / ₄	3 ¹ / ₄	4	5/8	3 ¹ / ₄	3
1	4 ⁷ / ₈	1 ¹¹ / ₁₆	2	3 ¹ / ₂	3 ¹ / ₄	4	5/8	3 ¹ / ₂	3 ¹ / ₄
1 1/4	5 ¹ / ₄	1 ¹³ / ₁₆	2 ¹ / ₂	3 ⁷ / ₈	3 ¹ / ₄	4	5/8	3 ³ / ₄	3 ¹ / ₂
1 1/2	6 ¹ / ₈	7/8	2 ⁷ / ₈	4 ¹ / ₂	7/8	4	3/4	4	3 ³ / ₄
2	6 ¹ / ₂	1	3 ⁵ / ₈	5	3/4	8	5/8	4	3 ³ / ₄
2 1/2	7 ¹ / ₂	1 ¹ / ₈	4 ¹ / ₈	5 ⁷ / ₈	7/8	8	3/4	4 ¹ / ₂	4 ¹ / ₄
3	8 ¹ / ₄	1 ¹ / ₄	5	6 ⁵ / ₈	7/8	8	3/4	4 ³ / ₄	4 ¹ / ₂
3 1/2	9	1 ¹ / ₈	5 ¹ / ₂	7 ¹ / ₄	1	8	7/8	5	5
4	10 ³ / ₄	1 ¹ / ₂	6 ³ / ₁₆	8 ¹ / ₂	1	8	7/8	5 ¹ / ₂	5 ¹ / ₄
5	13	1 ³ / ₄	7 ⁵ / ₁₆	10 ¹ / ₂	1 ¹ / ₈	8	1	6 ¹ / ₄	6
6	14	1 ⁷ / ₈	8 ¹ / ₂	11 ¹ / ₂	1 ¹ / ₈	12	1	6 ¹ / ₂	6 ¹ / ₄
8	16 ¹ / ₂	2 ³ / ₁₆	10 ⁵ / ₈	13 ³ / ₄	1 ¹ / ₄	12	1 ¹ / ₈	7 ¹ / ₂	7 ¹ / ₄
10	20	2 ¹ / ₂	12 ³ / ₄	17	1 ³ / ₈	16	1 ¹ / ₄	8 ¹ / ₄	8
12	22	2 ⁵ / ₈	15	19 ¹ / ₄	1 ³ / ₈	20	1 ¹ / ₄	8 ¹ / ₂	8 ¹ / ₄
14	23 ³ / ₄	2 ³ / ₄	16 ¹ / ₄	20 ³ / ₄	1 ¹ / ₂	20	1 ³ / ₈	9	8 ³ / ₄
16	27	3	18 ¹ / ₂	23 ³ / ₄	1 ⁵ / ₈	20	1 ¹ / ₂	9 ³ / ₄	9 ¹ / ₂
18	29 ¹ / ₄	3 ¹ / ₄	21	25 ³ / ₄	1 ³ / ₄	20	1 ⁵ / ₈	10 ¹ / ₂	10 ¹ / ₄
20	32	3 ¹ / ₂	23	28 ¹ / ₂	1 ³ / ₄	24	1 ⁵ / ₈	11 ¹ / ₄	11
24	37	4	27 ¹ / ₄	33	2	24	1 ⁷ / ₈	12 ³ / ₄	12 ¹ / ₂

The regular 1/4-inch raised face of Class 400 and 600 flanges is not included in the minimum flange thickness given above. The addition of any facing is beyond the outside edge of the flange.

Lengths of alloy steel stud bolts do not include the height of the points.

Bolt lengths not shown in the tables can be determined by reference to Appendix F of ANSI B16.5.

When flanges are integral with valves, the bolt holes, which are in multiples of four, are drilled to straddle the centerline unless otherwise ordered.

STEEL FLANGE DIMENSIONS

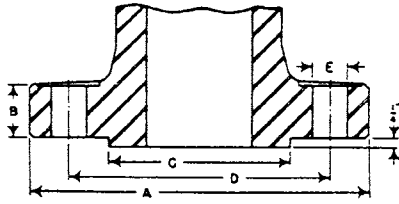

Class 900 1500 and 2500 Steel

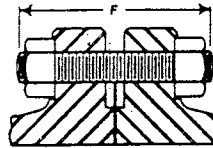

Male to Male
Flanged Joint

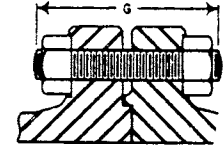

Male to Female
Flanged Joint
also for tongue to groove fl...

CLASS 900

Nominal Pipe Size	Flange Diameter A	Flange Thickness B	Diameter of Raised Face C	Diameter of Bolt Circle D	Diameter of Bolt Holes E	Number of Stud Bolts	Diameter of Stud Bolts	Length of Stud Bolts with 2 Nuts	
								F	G
3*	9½	1½	5	7½	1	8	⅞	5½	5¼
4	11½	1¾	6 ³ / ₁₆	9¼	1¼	8	1⅛	6½	6¼
5	13¾	2	7 ⁵ / ₁₆	11	1⅜	8	1¼	7¼	7
6	15	2 ³ / ₁₆	8½	12½	1¼	12	1⅛	7½	7¼
8	18½	2½	10 ⁵ / ₈	15½	1½	12	1⅜	8½	8¼
10	21½	2¾	12¾	18½	1½	16	1⅜	9	8¾
12	24	3⅛	15	21	1½	20	1⅜	9¾	9½
14	25¼	3¾	16¼	22	1⅝	20	1½	10½	10¼
16	27¾	3½	18½	24¼	1¾	20	1⅝	11	10¾
18	31	4	21	27	2	20	1⅞	12¾	12½
20	33¾	4¼	23	29½	2⅛	20	2	13½	13¼
24	41	5½	27¼	35½	2⅝	20	2½	17	16¾

*Use Class 1500 dimensions in sizes smaller than 3-inch.

CLASS 1500

Nominal Pipe Size	Flange Diameter A	Flange Thickness B	Diameter of Raised Face C	Diameter of Bolt Circle D	Diameter of Bolt Holes E	Number of Stud Bolts	Diameter of Stud Bolts	Length of Stud Bolts with 2 Nuts	
								F	G
½	4¾	⅞	1⅜	3¼	⅞	4	¾	4	3¾
¾	5⅞	1	1 ¹¹ / ₁₆	3½	⅞	4	¾	4¼	4
1	5⅞	1⅞	2	4	1	4	⅞	4¾	4½
1¼	6¼	1⅞	2½	4⅜	1	4	⅞	4¾	4½
1½	7	1¼	2⅞	4⅞	1⅞	4	1	5¼	5
2	8½	1½	3⅝	6½	1	8	⅞	5½	5¼
2½	9⅝	1⅝	4⅞	7½	1⅞	8	1	6	5¾
3	10½	1⅞	5	8	1¼	8	1⅞	6¾	6½
4	12¼	2⅞	6 ³ / ₁₆	9½	1⅜	8	1¼	7½	7¼
5	14¾	2⅞	7 ⁵ / ₁₆	11½	1⅝	8	1½	9½	9¼
6	15½	3¼	8½	12½	1½	12	1⅜	10	9¾
8	19	3⅝	10 ⁵ / ₈	15½	1¾	12	1⅝	11¼	11
10	23	4¼	12¾	19	2	12	1⅞	13¼	13
12	26½	4⅞	15	22½	2⅞	16	2	14¾	14½
14	29½	5¼	16¼	25	2⅝	16	2¼	16	15¾
16	32½	5¾	18½	27¾	2⅝	16	2½	17½	17¼
18	36	6¾	21	30½	2⅞	16	2¾	19¼	19
20	38¾	7	23	32¾	3⅞	16	3	21	20¾
24	46	8	27¼	39	3⅝	16	3½	24	23¾

The regular ¼-inch raised face of Class 900 and 1500 flanges is not included in the minimum flange thickness given above.

CLASS 2500

Nominal Pipe Size	Flange Diameter A	Flange Thickness B	Diameter of Raised Face C	Diameter of Bolt Circle D	Diameter of Bolt Holes E	Number of Stud Bolts	Diameter of Stud Bolts	Length of Stud Bolts with 2 Nuts	
								F	G
½	5¼	1 ⁷ / ₁₆	1⅜	3½	⅞	4	¾	4¾	4½
¾	5½	1¼	1 ¹¹ / ₁₆	3¾	⅞	4	¾	4¾	4½
1	6¼	1⅜	2	4¼	1	4	⅞	5¼	5
1¼	7¼	1½	2½	5⅞	1⅞	4	1	5¾	5½
1½	8	1¾	2⅞	5¾	1¼	4	1⅞	6½	6¼
2	9¼	2	3⅝	6¾	1⅞	8	1	6¾	6½
2½	10½	2¼	4⅞	7¾	1¼	8	1⅞	7½	7¼
3	12	2⅝	5	9	1⅜	8	1¼	8½	8¼
4	14	3	6 ³ / ₁₆	10¾	1⅝	8	1½	9¾	9½
5	16½	3⅝	7 ⁵ / ₁₆	12¾	1⅞	8	1¾	11½	11¼
6	19	4¼	8½	14½	2⅞	8	2	13½	13¼
8	21¾	5	10 ⁵ / ₈	17¼	2⅞	12	2	15	14¾
10	26½	6½	12¾	21¼	2⅝	12	2½	19	18¾
12	30	7¼	15	24⅝	2⅞	12	2¾	21	20¾

The regular ¼-inch raised face of Class 2500 flanges is not included in the minimum flange thickness given above. The addition of any facing is beyond the outside edge of the flange.

METRIC FLANGES & DIMENSIONS

NOM DIA (mm)	DIN PN6 900106	DIN PN10 900110	DIN PN16 900116	DIN PN25 900125	DIN PN40 900140	JIS 5K 900005	JIS 10K 900010	JIS 16K 900016	JIS 20K 900020	JIS 40K 900040	NOM DIA (mm)
15	D 80 BC 55 H 4 x 11	95 65 4 x 14	95 65 4 x 14	95 65 4 x 14	95 65 4 x 14	80 60 4 x 12	95 70 4 x 15	95 70 4 x 15	95 70 4 x 15	115 80 4 x 19	15
20	90 65 4 x 11	105 75 4 x 14	105 75 4 x 14	105 75 4 x 14	105 75 4 x 14	85 65 4 x 12	100 75 4 x 15	100 75 4 x 15	100 75 4 x 15	120 85 4 x 19	20
25	100 75 4 x 11	115 85 4 x 14	115 85 4 x 14	115 85 4 x 14	115 85 4 x 14	95 75 4 x 12	125 90 4 x 19	125 90 4 x 19	125 90 4 x 19	130 95 4 x 19	25
32	120 90 4 x 14	140 100 4 x 18	140 100 4 x 18	140 100 4 x 18	140 100 4 x 18	115 90 4 x 15	135 100 4 x 19	135 100 4 x 19	135 100 4 x 19	140 105 4 x 19	32
40	130 100 4 x 14	150 110 4 x 18	150 110 4 x 18	150 110 4 x 18	150 110 4 x 18	120 95 4 x 15	140 105 4 x 19	140 105 4 x 19	140 105 4 x 19	160 120 4 x 23	40
50	140 110 4 x 14	165 125 4 x 18	165 125 4 x 18	165 125 4 x 18	165 125 4 x 18	130 105 4 x 15	155 120 4 x 19	155 120 8 x 19	155 120 8 x 19	165 130 8 x 19	50
65	160 130 4 x 14	185 145 4 x 18	185 145 4 x 18	185 145 8 x 18	185 145 8 x 18	155 130 4 x 15	175 140 4 x 19	175 140 8 x 19	175 140 8 x 19	200 160 8 x 23	65
80	190 150 4 x 18	200 160 8 x 18	200 160 8 x 18	200 160 8 x 18	200 160 8 x 18	180 145 4 x 19	185 150 8 x 19	200 160 8 x 23	200 160 8 x 23	210 170 8 x 23	80
100	210 170 4 x 18	220 180 8 x 18	220 180 8 x 18	235 190 8 x 22	235 190 8 x 22	200 165 8 x 19	210 175 8 x 19	225 185 8 x 23	225 185 8 x 23	250 205 8 x 25	100
125	240 200 8 x 18	250 210 8 x 18	250 210 8 x 18	270 220 8 x 26	270 220 8 x 26	235 200 8 x 19	250 210 8 x 23	270 225 8 x 25	270 225 8 x 25	300 250 8 x 27	125
150	265 225 8 x 18	285 240 8 x 22	285 240 8 x 22	300 250 8 x 26	300 250 8 x 26	265 230 8 x 19	280 240 8 x 23	305 260 12 x 25	305 260 12 x 25	355 295 12 x 33	150
175	295 255 8 x 18	315 270 8 x 22	315 270 8 x 22	330 280 12 x 26	350 295 12 x 30	300 260 8 x 23	305 265 12 x 23				175
200	320 280 8 x 18	340 295 8 x 22	340 295 12 x 22	360 310 12 x 26	375 320 12 x 30	320 280 8 x 23	330 290 12 x 23	350 305 12 x 25	350 305 12 x 25	405 345 12 x 33	200
250	375 335 12 x 18	395 350 12 x 22	405 355 12 x 26	425 370 12 x 30	450 385 12 x 33	385 345 12 x 23	400 355 12 x 25	430 380 12 x 27	430 380 12 x 27	475 410 12 x 33	250
300	440 395 12 x 22	445 400 12 x 22	460 410 12 x 26	485 430 16 x 30	515 450 16 x 33	430 390 12 x 23	445 400 16 x 25	480 430 16 x 27	480 430 16 x 27	540 470 16 x 39	300
350	490 445 12 x 22	505 460 16 x 22	520 470 16 x 26	555 490 16 x 33	580 510 16 x 36	480 435 12 x 25	490 445 16 x 25	540 480 16 x 33	540 480 16 x 33	585 515 16 x 39	350
400	540 495 16 x 22	565 515 16 x 26	580 525 16 x 30	620 550 16 x 36	660 585 16 x 39	540 495 16 x 25	560 510 16 x 27	605 540 16 x 33	605 540 16 x 33	645 570 16 x 39	400
450	595 550 16 x 22	615 565 20 x 26	640 585 20 x 33	670 600 20 x 36	755 670 20 x 42	605 555 16 x 25	620 565 20 x 27	675 605 20 x 33			450
500	645 600 20 x 22	670 620 20 x 26	715 650 20 x 33	730 660 20 x 36	795 670 20 x 42	655 605 20 x 25	675 620 20 x 27	730 660 20 x 33		D BC H	500

D: Flange Diameter
 BC: Bolt Circle Diameter
 H: Bolt Holes x Hole Diameter
 1 inch = 25.4 mm

NAVY FLANGE DIMENSIONS

100/150 LB. MIL-F-20042 Flanges

SIZE	Diameter	Thickness	Bolt Circle	No. Of Holes	Hole Size
1/4	3 1/4	3/8	2 1/8	3	9/16
3/8	3 3/8	3/8	2 1/4	3	9/16
1/2	3 9/16	3/8	2 7/16	3	9/16
3/4	3 13/16	7/16	2 11/16	4	9/16
1	4 1/4	7/16	3 1/8	4	9/16
1 1/4	4 1/2	7/16	3 3/8	4	9/16
1 1/2	5 1/16	7/16	3 5/16	6	9/16
2	5 9/16	7/16	4 7/16	6	9/16
2 1/2	6 1/8	1/2	5	6	9/16
3	6 5/8	1/2	5 1/2	8	9/16
3 1/2	7 3/16	1/2	6 1/16	8	9/16
4	7 11/16	1/2	6 9/16	8	9/16
4 1/2	8 3/16	1/2	7 1/16	10	9/16
5	9 1/16	9/16	7 13/16	10	11/16
6	10 1/8	9/16	8 7/8	12	11/16
7	11 5/16	9/16	10	12	11/16
8	12 3/8	5/8	11 1/16	14	11/16
9	13 15/16	11/16	12 3/8	14	13/16
10	15	11/16	13 7/16	15	13/16
11	16 9/16	11/16	15	16	13/16
12	17 5/8	3/4	16 1/16	18	13/16

250 LB. MIL-F-20042 Flanges

SIZE	Diameter	Thickness	Bolt Circle	No. Of Holes	Hole Size
1/4	3 1/4	11/16	2 1/8	3	9/16
3/8	3 3/8	11/16	2 1/4	3	9/16
1/2	3 9/16	11/16	2 7/16	3	9/16
3/4	3 13/16	11/16	2 11/16	4	9/16
1	4 1/4	3/4	3 1/8	4	9/16
1 1/4	4 1/2	13/16	3 3/8	4	9/16
1 1/2	5 1/16	13/16	3 5/16	6	9/16
2	5 9/16	13/16	4 7/16	6	11/16
2 1/2	6 1/8	15/16	5	6	11/16
3	6 5/8	15/16	5 1/2	8	11/16
3 1/2	7 3/16	1	6 1/16	8	11/16
4	7 11/16	1	6 9/16	8	11/16
4 1/2	8 3/16	1	7 1/16	10	11/16
5	9 1/16	1 1/16	7 13/16	10	11/16
6	10 1/8	13/16	8 7/8	12	11/16
7	11 5/16	1 1/4	10	12	11/16
8	12 3/8	15/16	11 1/16	14	11/16
9	13 15/16	1 3/8	12 3/8	14	13/16
10	15	1 7/16	13 7/16	15	13/16
11	16 9/16	1 1/2	15	16	13/16
12	17 5/8	1 1/2	16 1/16	18	13/16

200 LB DWG 1385892 Butterfly Flanges

SIZE	Diameter	Thickness	Bolt Circle	No. Of Holes	Hole Size
3/8	3 1/2	5/16	2 3/8	4	5/8
1/2	3 1/2	5/16	2 3/8	4	5/8
3/4	3 7/8	11/32	2 3/4	4	5/8
1	4 1/4	3/8	3 1/8	4	5/8
1 1/4	4 5/8	13/32	3 1/2	4	5/8
1 1/2	5	7/16	3 7/8	4	5/8
2	6	1/2	4 3/4	4	3/4
2 1/2	7	9/16	5 1/2	4	3/4
3	7 1/2	5/8	6	4	3/4
3 1/2	8 1/2	11/16	7	8	3/4
4	9	11/16	7 1/2	8	3/4
5	10	3/4	8 1/2	8	7/8
6	11	13/16	9 1/2	8	7/8
8	13 1/2	15/16	11 3/4	8	7/8
10	16	1	14 1/4	12	1
12	19	1 1/8	17	12	1

400 LB. MIL-F-20042 Flanges

SIZE	Diameter	Thickness	Bolt Circle	No. Of Holes	Hole Size
1/4	3 3/4	11/16	2 5/8	3	9/16
3/8	3 7/8	11/16	2 3/4	4	9/16
1/2	4	11/16	2 7/8	4	9/16
3/4	4 5/16	11/16	3 3/16	4	9/16
1	5 1/16	3/4	3 3/4	5	11/16
1 1/4	5 3/8	13/16	4 1/16	5	11/16
1 1/2	5 15/16	13/16	4 5/8	6	11/16
2	6 1/2	13/16	5 3/16	7	11/16
2 1/2	7 9/16	15/16	6	8	13/16
3	8 1/8	15/16	6 9/16	8	13/16
3 1/2	8 11/16	1	7 1/8	9	13/16
4	9 1/4	1	7 11/16	9	13/16
5	10 3/8	1 1/16	8 13/16	11	13/16
6	11 15/16	13/16	10 3/16	12	15/16
8	14 3/4	15/16	12 3/4	13	1 1/16
10	17	1 7/16	15	15	1 1/16

50 LB. MIL-F-20042 Flanges

SIZE	Diameter	Thickness	Bolt Circle	No. Of Holes	Hole Size
12	16 9/16	11/16	15	16	13/16
14	19 1/8	3/4	17 3/8	19	15/16
16	21 3/16	3/4	19 7/16	20	15/16
18	23 1/4	7/8	21 1/2	22	15/16
20	25 13/16	7/8	23 13/16	24	1 1/16
22	27 7/8	7/8	25 7/8	26	1 1/16
24	30	1	28	28	1 1/16
26	32 9/16	1	30 5/16	30	1 3/16
28	34 11/16	1	32 7/16	32	1 1/16
30	36 13/16	1 1/8	34 9/16	35	1 3/16
32	39	1 1/8	36 3/4	36	1 3/16
34	41	1 1/8	38 3/4	36	1 3/16
36	43 7/8	1 1/4	41 3/8	36	1 5/16
38	46 1/8	1 1/4	43 5/8	36	1 5/16
40	48 1/8	1 1/4	45 5/8	36	1 5/16

700 LB. DWG 1385947 Flanges

SIZE	Diameter	Thickness	Bolt Circle	No. Of Holes	Hole Size
1/4	3 1/4	11/16	2 1/8	3	9/16
3/8	3 3/8	11/16	2 1/4	3	9/16
1/2	3 9/16	11/16	2 7/16	3	9/16
3/4	3 13/16	11/16	2 11/16	4	9/16
1	4 1/4	3/4	3 1/8	4	9/16
1 1/4	4 1/2	13/16	3 3/8	4	9/16
1 1/2	5 1/16	13/16	3 5/16	6	9/16
2	5 9/16	15/16	4 7/16	6	11/16
2 1/2	6 1/8	1 1/16	5	6	11/16
3	7 7/16	1 3/8	5 15/16	8	11/16
3 1/2	8	1 7/16	6 1/2	8	11/16
4	8 11/16	1 7/16	7 1/16	10	11/16
5	9 3/4	1 5/8	8 1/4	12	11/16
6	10 7/8	1 15/16	9 3/8	14	11/16
8	13 1/8	2 1/8	11 5/8	16	11/16

VALVE DIMENSIONS: ANSI

SIZE	CAST IRON		CAST STEEL								SIZE
	125 LB FLGD	250 LB FLGD	150 LB FLGD	150 LB B/W	300 LB	400 LB	600 LB	900 LB	1500 LB	2500 LB	
ANSI GATE VALVE FACE-TO-FACE DIMENSION											
1			5	5		8-1/2	8-1/2	10	10	12-1/8	1
1-1/4			5-1/2	5-1/2		9	9	11	11	13-3/4	1-1/4
1-1/2			6-1/2	6-1/2	7-1/2	9-1/2	9-1/2	12	12	15-1/8	1-1/2
2	7	8 1/2	7	8-1/2	8-1/2	11-1/2	11-1/2	14-1/2	14-1/2	17-3/4	2
2-1/2	7-1/2	9-1/2	7-1/2	9-1/2	9-1/2	13	13	16-1/2	16-1/2	20	2-1/2
3	8	11-1/8	8	11-1/8	11-1/8	14	14	15	18-1/2	22-3/4	3
3-1/2	8-1/2	11-7/8	8-1/2		11-7/8	15	15	17	19-1/2		3-1/2
4	9	12	9	12	12	16	17	18	21-1/2	26-1/2	4
5	10	15	10	15	15	18	20	22	26-1/2	31-1/4	5
6	10-1/2	15-7/8	10-1/2	15-7/8	15-7/8	19-1/2	22	24	27-3/4	36	6
8	11-1/2	16-1/2	11-1/2	16-1/2	16-1/2	23-1/2	26	29	32-3/4	40-1/4	8
10	13	18	13	18	18	26-1/2	31	33	39	50	10
12	14	19-3/4	14	19-3/4	19-3/4	30	33	38	44-1/2	56	12
14	15	22-1/2	15	22-1/2	30	32-1/2	35	40-1/2	49-1/2		14
16	16	24	16	24	33	35-1/2	39	44-1/2	54-1/2		16
18	17	26	17	26	36	38-1/2	43	48	60-1/2		18
20	18	28	18	28	39	41-1/2	47	52	65-1/2		20
24	20	31	20	32	45	48-1/2	55	61	76-1/2		24
GLOBE, SWING CHECK*, ANGLE** VALVES FACE-TO-FACE DIMENSIONS											
1			5**	5**	8*	8-1/2	8-1/2	10	10	12-1/8	1
1-1/4			5-1/2**	5-1/2**	8-1/2*	9	9	11	11	13-3/4	1-1/4
1-1/2			6-1/2	6-1/2	9*	9-1/2	9-1/2	12	12	15-1/8	1-1/2
2	8	10-1/2	8	8	10-1/2	11-1/2	11-1/2	14-1/2	14-1/2	17-3/4	2
2-1/2	8-1/2	11-1/2	8-1/2	8-1/2	11-1/2	13	13	16-1/2	16-1/2	20	2-1/2
3	9-1/2	12-1/2	9-1/2	9-1/2	12-1/2	14	14	15	18-1/2	22-3/4	3
3-1/2	10-1/2	13-1/4	10-1/2	10-1/2	13-1/4	15	15	17	19-1/2		3-1/2
4	11-1/2	14	11-1/2	11-1/2	14	16	17	18	21-1/2	26-1/2	4
5	13	15-3/4	14*	14*	15-3/4	18	20	22	26-1/2	31-1/4	5
6	14	17-1/2	16*	16*	17-1/2	19-1/2	22	24	27-3/4	36	6
8	19-1/2	21	19-1/2	19-1/2	22*	23-1/2	26	29	32-3/4	40-1/4	8
10	24-1/2	24-1/2	24-1/2	24-1/2	24-1/2	26-1/2	31	33	39	50	10
12	27-1/2	28	27-1/2	27-1/2	28	30	33	38	44-1/2	56	12

* Swing check F-F equals globe valve except 5" & 6" 150 LB @ 13" & 14" and 1", 1 1/4", 1 1/2", 8" 300 LB @ 8 1/2", 9", 9 1/2", 21" respectively.

** Angle valve centerline-to-face is 1/2 of globe F-F except 1" & 1 1/4" 150 LB which are 2 3/4" & 3" C-F length

WORKING PRESSURES FOR VALVES ANSI B16.34-1977 MAXIMUMS

All pressures are in pounds per square inch (Gauge).
Temperatures and pressures listed are maximum internal fluid temperatures and pressures.

Pressure Class Rating	150	300	600	900	1500	2500	4500
Hydrostatic Shell Test Pressure (PSIG)	450	1125	2250	3375	5625	9375	16875
Working Temp. (Deg. F.)	Material ASTM Specification Alloy Grade Designation	Maximum Non-Shock Working Pressure (PSIG) Standard Class Valves					
-20 to 100	WCB	285	740	1480	2220	3705	6170
	WC6	290	750	1500	2250	3750	6250
	WC9	290	750	1500	2250	3750	6250
	C5	290	750	1500	2250	3750	6250
	LCB	265	695	1390	2085	3470	5785
	CF8M	275	720	1440	2160	3600	6000
200	WCB	260	665	1350	2025	3375	5625
	WC6	260	710	1425	2135	3560	5930
	WC9	260	715	1430	2150	3580	5965
	C5	260	750	1500	2250	3750	6250
	LCB	250	655	1315	1970	3280	5470
	CF8M	240	620	1240	1860	2795	4660
300	WCB	230	655	1315	1970	3280	5470
	WC6	230	675	1345	2020	3365	5605
	WC9	230	675	1355	2030	3385	5640
	C5	230	730	1455	2185	3640	6070
	LCB	230	640	1275	1915	3190	5315
	CF8M	215	560	1120	1680	2795	4660
400	WCB	200	635	1270	1900	3170	5280
	WC6	200	660	1315	1975	3290	5485
	WC9	200	650	1295	1945	3240	5400
	C5	200	705	1410	2115	3530	5880
	LCB	200	620	1235	1850	3085	5145
	CF8M	195	515	1030	1540	2570	4280
500	WCB	170	600	1200	1795	2995	4990
	WC6	170	640	1285	1925	3210	5350
	WC9	170	640	1280	1920	3200	5330
	C5	170	665	1330	1995	3325	5540
	LCB	170	585	1165	1745	2910	4850
	CF8M	170	480	955	1435	2390	3980
600	WCB	140	550	1095	1640	2735	4560
	WC6	140	605	1210	1815	3025	5040
	WC9	140	605	1210	1815	3025	5040
	C5	140	605	1210	1815	3025	5040
	LCB	140	535	1065	1600	2665	4440
	CF8M	140	450	905	1355	2255	3760
650	WCB	125	535	1075	1610	2685	4475
	WC6	125	590	1175	1765	2940	4905
	WC9	125	590	1175	1765	2940	4905
	C5	125	590	1175	1765	2940	4905
	LCB	125	525	1045	1570	2615	4355
	CF8M	125	445	890	1330	2220	3700

Pressure Class Rating	150	300	600	900	1500	2500	4500
Hydrostatic Shell Test Pressure (PSIG)	450	1125	2250	3375	5625	9375	16875
Working Temp. (Deg. F.)	Material ASTM Specification Alloy Grade Designation	Maximum Non-Shock Working Pressure (PSIG) Standard Class Valves					
700	WCB	110	535	1065	1600	2665	4440
	WC6	110	570	1135	1705	2840	4730
	WC9	110	570	1135	1705	2840	4730
	C5	110	570	1135	1705	2840	4730
	CF8M	110	430	865	1295	2160	3600
750	WCB	95	505	1010	1510	2520	4200
	WC6	95	530	1065	1595	2660	4430
	WC9	95	530	1065	1595	2660	4430
	C5	95	530	1065	1595	2660	4430
	CF8M	95	425	845	1270	2110	3520
800	WCB	80	410	825	1235	2060	3430
	WC6	80	510	1015	1525	2540	4230
	WC9	80	510	1015	1525	2540	4230
	C5	80	500	995	1490	2485	4145
	CF8M	80	415	830	1245	2075	3460
850	WCB ¹⁾	65	270	535	805	1340	2230
	WC6	65	485	975	1460	2435	4060
	WC9	65	480	975	1460	2435	4060
	C5	65	440	880	1315	2195	3660
900	WCB ¹⁾	50	170	345	515	860	1430
	WC6	50	450	900	1350	2245	3745
	WC9	50	450	900	1350	2245	3745
	C5	50	355	705	1060	1765	2945
950	WCB ¹⁾	35	105	205	310	515	860
	WC6	35	380	755	1130	1885	3145
	WC9	35	380	755	1130	1885	3145
	C5	35	260	520	780	1305	2170
1000	WCB ¹⁾	20	50	105	155	260	430
	WC6	20	225	445	670	1115	1860
	WC9	20	270	535	805	1340	2230
	C5	20	190	385	575	960	1600
1050	WC6	20 ²⁾	140	275	410	685	1145
	WC9	20 ²⁾	200	400	595	995	1660
	C5	20 ²⁾	140	280	420	705	1170
1100	WC6	20 ²⁾	95	190	290	480	800
	WC9	20 ²⁾	115	225	340	565	945
	C5	20 ²⁾	105	205	310	515	860
1150	C5	20 ²⁾	70	140	205	345	570
1200	C5	20 ²⁾	45	90	135	225	370

¹⁾ Permissible but not recommended by ANSI B16.34 for prolonged use above ± 800°F.

²⁾ For welded end valve only.

ANSI B16.34 flanged end rating terminal at 1000°F.

WORKING PRESSURES: PIPE & TUBE

Information on this page is provided only as theoretical data and is not to be understood as a recommendation or specific guideline for application.

SEAMLESS CARBON STEEL PIPE

NOMINAL PIPE SIZE	MAXIMUM ALLOWABLE WORKING PRESSURES AT -20F TO 650F ▶												
	SCHED 10	SCHED 20	SCHED 30	STD WALL	SCHED 40	SCHED 60	EXTRA STRONG	SCHED 80	SCHED 100	SCHED 120	SCHED 140	SCHED 160	XX STRONG
1/2	—	—	—	1694	1694	—	3036	3036	—	—	—	—	9223
3/4	659	—	—	1450	1450	—	2589	2589	—	—	—	—	7531
1	065	—	—	1578	1578	—	2601	2601	—	—	—	—	7150
1 1/4	556	—	—	1069	1069	—	1941	1941	—	—	—	—	5593
1 1/2	486	—	—	1004	1004	—	1821	1821	—	—	—	—	5114
2	388	—	—	903	903	—	1659	1659	—	—	—	—	4475
2 1/2	431	—	—	1214	1214	—	1936	1936	—	—	—	—	4936
3	346	—	—	1094	1094	—	1773	1773	—	—	—	—	4405
3 1/2	303	—	—	1023	1023	—	1671	1671	—	—	—	—	—
4	269	—	—	974	974	—	1598	1598	—	2243	—	—	3858
5	284	—	—	888	888	—	1475	1475	—	2123	—	—	3485
6	239	—	—	833	833	—	1473	1473	—	2038	—	—	3414
8	225	543	628	770	770	1343	1343	1649	2068	2388	2715	2605	—
10	224	434	578	723	723	1070	1070	1311	1641	1975	2406	2754	—
12	219	366	534	630	696	1033	898	1305	1653	2009	2295	2735	—
14	333	451	573	573	693	999	816	1311	1690	2013	2341	2675	—
16	291	395	500	500	711	980	711	1305	1638	1975	2378	2669	—
18	258	350	538	444	725	1013	631	1303	1648	1998	2303	2665	—
20	233	399	568	399	693	995	568	1299	1653	1970	2338	2663	—
22	211	—	—	363	—	—	515	—	—	—	—	—	—
24	194	331	541	331	683	1004	471	1295	1664	2003	2309	2656	—
26	—	—	—	306	—	—	435	—	—	—	—	—	—
30	209	376	488	265	—	—	376	—	—	—	—	—	—
36	—	—	—	220	—	—	314	—	—	—	—	—	—
42	—	—	—	189	—	—	269	—	—	—	—	—	—

For allowable working pressures at higher temperatures, multiply listed values by the following factors:

GRADE A

Temperature	700°F	750°F	800°F	850°F	900°F
Multiplying Factor	.974	.892	.750	.708	.417

GRADE B

Temperature	700°F	750°F	800°F	850°F	900°F
Multiplying Factor	.956	.863	.720	.520	.333

VARIOUS TUBE

Information on this page is provided only as theoretical data and is not to be understood as a recommendation or specific guideline for application.

Calculating theoretical allowable working pressures of tubing equals multiplier below x "S" value from chart. This is for ambient temperature applications. See below for temperature factors (multipliers) above 200°F.

TUBE O.D. (IN.)	TUBE WALL THICKNESS (INCHES)											
	.028	.035	.049	.065	.083	.095	.109	.120	.134	.148	.156	
1/8"	.533*	.676*	*LAME'S FORMULA									
3/16"	.339	.436*	.628*									
1/4"	.244	.315	.460*	.625*								
5/16"	.245	.358	.492*									
3/8"	.201	.291	.402*									
1/2"	.148	.212	.290	.382								
5/8"	.117	.167	.226	.296	.346							
3/4"	.137	.186	.242	.281	.328							
7/8"	.117	.157	.205	.237	.276							
1"	.101	.137	.177	.205	.238	.265						
1 1/4"	.1085	.1402	.1618	.1874	.2079	.2345	.2615	.2773				
1 1/2"	.1158	.1334	.1543	.1709	.1924	.2142	.2268					
2"	.0987	.1139	.1260	.1416	.1573	.1664						

Material	"S" Value	Specification	Tensile
Carbon Steel	15700	Hydraulic A-179	47000
Stainless	20000	Annealed A-269, A-213	75000
Monel	18700	Smis 400 B-165	70000
Copper	60000	Types L, K B-88, B-75	30000
Aluminum	14200	Series 6061T6 B-218	42000

°F	FACTORS					
	ALUMINUM	COPPER	STEEL	304SS	316SS	MONEL
200	1.00	.80	.95	1.00	1.00	.88
400	.40	.50	.86	.93	.96	.79
600	—	—	.77	.82	.85	.79
800	—	—	.58	.76	.79	.76
1000	—	—	—	.69	.76	—
1200	—	—	—	.30	.37	—

CONVERSIONS | 2NOISREVNOC

Use the table by starting in the FC column and then reading to the left or right for Celsius or Fahrenheit.

C =	FC	= F	C =	FC	= F	C =	FC	= F	C =	FC	= F	C =	FC	= F	C =	FC	= F
-273.0	-459.4		-17.2	1	33.8				32.8	91	195.8	260	500	932	538	1000	1832
-268.0	-450.0		-16.7	2	35.6				33.3	92	197.6	266	510	950	549	1020	1868
-262.0	-440.0		-16.1	3	37.4				33.9	93	199.4	271	520	968	560	1040	1904
-257.0	-430.0		-15.6	4	39.2	9.4	49	120.2	34.3	94	201.2	277	530	986	571	1060	1940
-251.0	-420.0		-15.0	5	41.0	10.0	50	122.0	35.0	95	203.0	282	540	1004	582	1080	1976
-246.0	-410.0		-14.4	6	42.8	10.6	51	123.8	35.6	96	204.8	288	550	1022	593	1100	2012
-240.0	-400.0		-13.9	7	44.6	11.1	52	125.6	36.1	97	206.6	293	560	1040	604	1120	2048
-234.0	-390.0		-13.3	8	46.4	11.7	53	127.4	36.7	98	208.4	299	570	1058	616	1140	2084
-229.0	-380.0		-12.8	9	48.2	12.2	54	129.2	37.2	99	210.2	304	580	1076	627	1160	2120
-223.0	-370.0		-12.2	10	50.0	12.8	55	131.0	37.8	100	212.0	310	590	1094	638	1180	2156
-218.0	-360.0		-11.7	11	51.8	13.3	56	132.8	43.0	110	230.0	316	600	1112	649	1200	2192
-212.0	-350.0		-11.1	12	53.6	13.9	57	134.6	49.0	120	248.0	321	610	1130	660	1220	2228
-207.0	-340.0		-10.6	13	55.4	14.4	58	136.4	54.0	130	266.0	327	620	1148	671	1240	2264
-201.0	-330.0		-10.0	14	57.2	15.0	59	138.2	60.0	140	284.0	332	630	1166	682	1260	2300
-196.0	-320.0		- 9.4	15	59.0	15.6	60	140.0	66.0	150	302	338	640	1184	693	1280	2336
-190.0	-310.0		- 8.9	16	60.8	16.1	61	141.8	71.0	160	320	343	650	1202	704	1300	2372
-184.0	-300.0		- 8.3	17	62.6	16.7	62	143.6	77.0	170	338	349	660	1220	732	1350	2462
-179.0	-290.0		- 7.8	18	64.4	17.2	63	145.4	82.0	180	356	354	670	1238	760	1400	2552
-173.0	-280.0		- 7.2	19	66.2	17.8	64	147.2	88.0	190	374.0	360	680	1256	788	1450	2642
-169.0	-273.0	-459.4	- 6.7	20	68.0	18.3	65	149.0	93.0	200	392.0	366	690	1274	816	1500	2732
-168.0	-270.0	-454.0	- 6.1	21	69.8	18.9	66	150.8	99.0	210	410.0	371	700	1292	843	1550	2822
-162.0	-260.0	-436.0	- 5.6	22	71.6	19.4	67	152.6	100.0	212	413.6	377	710	1310	871	1600	2912
-157.0	-250.0	-418.0	- 5.0	23	73.4	20.0	68	154.4	104.0	220	428.0	382	720	1328	899	1650	3002
-151.0	-240.0	-400.0	- 4.4	24	75.2	20.6	69	156.2	110.0	230	446.0	388	730	1346	927	1700	3092
-146.0	-230.0	-382.0	- 3.9	25	77.0	21.1	70	158.0	116.0	240	464.0	393	740	1364	954	1750	3182
-140.0	-220.0	-364.0	- 3.3	26	78.8	21.7	71	159.8	121.0	250	482.0	399	750	1382	982	1800	3272
-134.0	-210.0	-346.0	- 2.8	27	80.6	22.2	72	161.6	127.0	260	500.0	404	760	1400	1010	1850	3362
-129.0	-200.0	-328.0	- 2.2	28	82.4	22.8	73	163.4	132.0	270	518.0	410	770	1418	1038	1900	3452
-123.0	-190.0	-310.0	- 1.7	29	84.2	23.3	74	165.2	138.0	280	536.0	416	780	1436	1066	1950	3542
-118.0	-180.0	-292.0	- 1.1	30	86.0	23.9	75	167.0	143.0	290	554.0	421	790	1454	1093	2000	3632
-112.0	-170.0	-274.0	- 0.6	31	87.8	24.4	76	168.8	149.0	300	572.0	427	800	1472	1121	2050	3722
-107.0	-160.0	-256.0	0.0	32	89.6	25.0	77	170.6	154.0	310	590.0	442	810	1490	1149	2100	3812
-101.0	-150.0	-238.0	0.6	33	91.4	25.6	78	172.4	160.0	320	608.0	438	820	1508	1177	2150	3902
- 96.0	-140.0	-220.0	1.1	34	93.2	26.1	79	174.2	166.0	330	626.0	443	830	1526	1204	2200	3992
- 90.0	-130.0	-202.0	1.7	35	95.0	26.7	80	176.0	171.0	340	644.0	449	840	1544	1232	2250	4082
- 84.0	-120.0	-184.0	2.2	36	96.8	27.2	81	177.8	177.0	350	662.0	454	850	1562	1260	2300	4172
- 79.0	-110.0	-166.0	2.8	37	98.6	27.8	82	179.6	182.0	360	680.0	460	860	1580	1288	2350	4262
- 73.0	-100.0	-148.0	3.3	38	100.4	28.3	83	181.4	188.0	370	698.0	466	870	1598	1316	2400	4352
- 68.0	- 90.0	-130.0	3.9	39	102.2	28.9	84	183.2	193.0	380	716.0	471	880	1616	1343	2450	4442
- 62.0	- 80.0	-112.0	4.4	40	104.0	29.4	85	185.0	199.0	390	734.0	477	890	1634	1371	2500	4532
- 57.0	- 70.0	- 94.0	5.0	41	105.8	30.0	86	186.8	204.0	400	752.0	482	900	1652	1399	2550	4622
- 51.0	- 60.0	- 76.0	5.6	42	107.6	30.6	87	188.6	210.0	410	770.0	488	910	1670	1427	2600	4712
- 46.0	- 50.0	- 58.0	6.1	43	109.4	31.1	88	190.4	216.0	420	788.0	493	920	1688	1454	2650	4802
- 40.0	- 40.0	- 40.0	6.7	44	111.2	31.7	89	192.2	221.0	430	806.0	499	930	1706	1482	2700	4892
- 34.0	- 30.0	- 22.0	7.2	45	113.0	32.2	90	194.0	227.0	440	824.0	504	940	1724	1510	2750	4982
- 29.0	- 20.0	- 4.0	7.8	46	114.8				232.0	450	842.0	510	950	1742	1538	2800	5072
- 23.0	- 10.0	14.0	8.3	47	116.6				238.0	460	860.0	516	960	1760	1566	2850	5162
- 7.8	- 0.0	32.0	8.9	48	118.4				243.0	470	878.0	521	970	1778	1593	2900	5252
									249.0	480	896.0	527	980	1796	1621	2950	5342
									254.0	490	914.0	532	990	1814	1649	3000	5432

CONVERSIONS

(1 inch = 25.4 millimeter)

ADDITIONAL GENERAL TABLES - PAGE 122

inch	0	1/16	1/8	3/16	1/4	5/16	3/8	7/16	1/2	9/16	5/8	11/16	3/4	13/16	7/8	15/16
0	0.0	1.6	3.2	4.8	6.4	7.9	9.5	11.1	12.7	14.3	15.9	17.5	19.1	20.6	22.2	23.8
1	25.4	27.0	28.6	30.2	31.8	33.3	34.9	36.5	38.1	39.7	41.3	42.9	44.5	46.0	47.6	49.2
2	50.8	52.4	54.0	55.6	57.2	58.7	60.3	61.9	63.5	65.0	66.7	68.3	69.9	71.4	73.0	74.6
3	76.2	77.8	79.4	81.0	82.6	84.1	85.7	87.3	88.9	90.5	92.1	93.7	95.3	96.8	98.4	100.0
4	101.6	103.2	104.8	106.4	108.0	109.5	111.1	112.7	114.3	115.9	117.5	119.1	120.7	122.2	123.8	125.4
5	127.0	128.6	130.2	131.8	133.4	134.9	136.5	138.1	139.7	141.3	142.9	144.5	146.1	147.6	149.2	150.8
6	152.4	154.0	155.6	157.2	158.8	160.3	161.9	163.5	165.1	166.7	168.3	169.9	171.5	173.0	174.6	176.2
7	177.8	179.4	181.0	182.6	184.2	185.7	187.3	188.9	190.5	192.1	193.7	195.3	196.9	198.4	200.0	201.6
8	203.2	204.8	206.4	208.0	209.6	211.1	212.7	214.3	215.9	217.5	219.1	220.7	222.3	223.8	225.4	227.0
9	228.6	230.2	231.8	233.4	235.0	236.5	238.1	239.7	241.3	242.9	244.5	246.1	247.7	249.2	250.8	252.4
10	254.0	255.6	257.2	258.8	260.4	261.9	263.5	265.1	266.7	268.3	269.9	271.5	273.1	274.6	276.2	277.8
11	279.4	281.0	282.6	284.2	285.9	287.3	288.9	289.5	292.1	293.7	295.3	296.9	298.5	300.0	301.6	303.2
12	304.8	306.4	308.0	309.6	311.2	312.7	314.3	315.9	317.5	319.1	320.7	322.3	323.9	325.4	327.0	328.6
13	330.2	331.8	333.4	335.0	336.6	338.1	339.7	341.3	342.9	344.5	346.1	347.7	349.3	350.8	352.4	354.0
14	355.6	357.2	358.8	360.4	362.0	363.5	365.1	366.7	368.3	369.9	371.5	373.1	374.7	376.2	377.8	379.4
15	381.0	382.6	384.2	385.8	387.4	388.9	390.5	392.1	393.7	395.3	396.9	398.5	400.1	401.6	403.2	404.8
16	406.4	408.0	409.6	411.2	412.8	414.3	415.9	417.5	419.1	420.7	422.3	423.9	425.5	427.0	428.6	430.2
17	431.8	433.4	435.0	436.6	438.2	439.7	441.3	442.9	444.5	446.1	447.7	449.3	450.9	452.4	454.0	455.6
18	457.2	458.8	460.4	462.0	463.6	465.1	466.7	468.3	469.9	471.5	473.1	474.7	476.3	477.8	479.4	481.0
19	482.6	484.2	485.8	487.4	489.0	490.5	492.1	493.7	495.3	496.9	498.5	500.1	501.7	503.2	504.8	506.4
20	508.0	509.6	511.2	512.8	514.4	515.9	517.5	519.1	520.7	522.3	523.9	525.5	527.1	528.6	530.2	531.8
21	533.4	535.0	536.6	538.2	539.8	541.3	542.9	544.5	546.1	547.7	549.3	550.9	552.5	554.0	555.6	557.2
22	558.8	560.4	562.0	563.6	565.2	566.7	568.3	569.9	571.5	573.1	574.7	576.3	577.9	579.4	581.0	582.6
23	584.2	585.8	587.4	589.0	590.6	592.1	593.7	595.3	596.9	598.5	600.1	601.7	603.3	604.8	606.4	608.0
24	609.6	611.2	612.8	614.4	616.0	617.5	619.1	620.7	622.3	623.9	625.5	627.1	628.7	630.2	631.8	633.4
25	635.0	636.6	638.2	639.8	641.4	642.9	644.5	646.1	647.7	649.3	650.9	652.5	654.1	655.6	657.2	658.8
26	660.4	662.0	663.6	665.2	666.8	668.3	669.9	671.5	673.1	674.7	676.3	677.9	679.5	681.0	682.6	684.2
27	685.8	687.4	689.0	690.6	692.2	693.7	695.3	696.9	698.5	700.1	701.7	703.3	704.9	706.4	708.0	709.6
28	711.2	712.8	714.4	716.0	717.6	719.1	720.7	722.3	723.9	725.5	727.1	728.7	730.3	731.8	733.4	735.0
29	736.6	738.2	739.8	741.4	743.0	744.5	746.1	747.7	749.3	750.9	752.5	754.1	755.7	757.2	758.8	760.4
30	762.0	763.6	765.2	766.8	768.4	769.9	771.5	773.1	774.7	776.3	777.9	779.5	781.1	782.6	784.2	785.8
31	787.4	789.0	790.6	792.2	793.8	795.3	796.9	798.5	800.1	801.7	803.3	804.9	806.5	808.0	809.6	811.2
32	812.8	814.4	816.0	817.6	819.2	820.7	822.3	823.9	825.5	827.1	828.7	830.3	831.9	833.4	835.0	836.6
33	838.2	839.8	840.4	843.0	844.6	846.1	847.7	849.3	850.9	852.5	854.1	855.7	857.3	858.8	860.4	862.0
34	863.6	865.2	866.8	868.4	870.0	871.5	873.1	874.7	876.3	877.9	879.5	881.1	882.7	884.2	885.8	887.4
35	889.0	890.6	892.2	893.8	895.4	896.9	898.5	900.1	901.7	903.3	904.9	906.5	908.1	909.6	911.2	912.8
36	914.4	916.0	917.6	919.2	920.8	922.3	923.9	925.5	927.1	928.7	930.3	931.9	933.5	935.0	936.6	938.2
37	939.8	941.4	943.0	944.6	946.2	947.7	949.3	950.9	952.5	954.1	955.7	957.3	958.9	960.4	962.0	963.6
38	965.2	966.8	968.4	970.0	971.6	973.1	974.7	976.3	977.9	979.5	981.1	982.7	984.3	985.8	987.4	989.0
39	990.6	992.2	993.8	995.4	997.0	998.5	1000.1									

Multiply by	To convert	To	
2.54	Inches	Centimetres	0.3937
30.48	Feet	Centimetres	0.3048
0.914	Yards	Metres	1.094
1,609.3	Miles	Metres	0.00021
1,853.27	Nautical Miles	Metres	0.000539
6.45	Square inches	Sq. cms.	0.155
0.093	Square feet	Sq. Metres	10.764
0.836	Square yards	Sq. Metres	1.196
16.39	Cubic inches	Cub. cms.	0.061
28.3	Cubic feet	Litres	0.0353
6.24	Cubic feet	Gallons	0.1602
0.765	Cubic yards	Cub. Metres	1.308
0.3732	Pounds (Troy)	Kilogrammes	2.68
31.10	Ounces (Troy)	Grammes	0.03216
0.4536	Pounds (Avoir.)	Kilogrammes	2.2046
7.000	Pounds (Avoir.)	Grains (Troy)	0.000143
28.35	Ounces (Avoir.)	Grammes	0.0353
0.065	Grains	Grammes	15.38
50.8	Cwt.	Kilogrammes	0.01968
1,016	Tons	Kilogrammes	0.000984
4.546	Gallons	Litres	0.22
10	Gallons of water	Pounds	0.1
0.454	Pounds of water	Litres	2.202
70.3	Lb. per sq. in.	Gm. sq. cm.	0.0142
2.3	Lb. per sq. in.	H'd of water (ft.)	0.434
	To obtain	From	Multiply by above

Multiply by	To convert	To	
0.7	Lb. per sq. in.	H'd of water (M.)	1.4285
0.068	Lb. per sq. in.	Atmospheres	14.7
1.575	Tons per sq. in.	Kgm., sq. mm.	0.635
4.883	Lb. per sq. ft.	Kgm./sq. metre	0.205
0.593	Lb. per cub. yd.	Kgm./cub. metre	1.686
16.02	Lb. per cub. ft.	Kgm./cub. metre	0.0624
0.0996	Lb. per gallon	Kgm./litre	10.02
0.1633	Foot-lb.	K'grammetres	7.23
0.33	Foot-tons	Tonne-metres	3
1.014	Horse-Power	Forces de cheval	0.9861
746	Horse-Power	Watts	0.00134
33,000	Horse-Power	Ft.-lb. min.	—
76	Horse-Power	Kg.-m. sec.	0.01316
44	Watts	Ft.-lb. min.	0.0227
0.1	Watts	Kg.-m. sec.	10
0.252	Heat units	Calories	3.97
14.7	Atmospheres	Lb. sq. inch	0.068
0.90	German candles	English candles	1.1111
9.55	Carrels	Candles	0.1047
0.737	Joules	Ft. lb.	1.357
88	Miles hour	Ft. min.	0.01134
197	Metres sec.	Ft. min.	0.00508
1.8	C.H.U.	B.Th.U.	0.5555
0.208	Centipoise	Lb. force sec. sq. ft.	4.8
	To obtain	From	Multiply by above

FRACTIONS, DECIMALS & MILLIMETERS

inches			inches			inches			inches		
fractions	decimals	mm	fractions	decimals	mm	fractions	decimals	mm	fractions	decimals	mm
---	.0004	.01	25/32	.781	19.844	---	2.165	55.	3-11/16	3.6875	93.863
---	.004	.10	---	.7874	20.	2-3/16	2.1875	55.563	---	3.7008	94.
---	.01	.25	51/64	.797	20.241	---	2.2047	56.	3-23/32	3.719	94.456
1/64	.0156	.397	13/16	.8125	20.638	2-7/32	2.219	56.358	---	3.7401	95.
---	.0197	.50	---	.8268	21.	---	2.244	57.	3-3/4	3.750	95.250
---	.0295	.75	53/64	.828	21.034	2-1/4	2.250	57.150	---	3.7795	96.
1/32	.03125	.794	27/32	.844	21.431	2-9/32	2.281	57.944	3-25/32	3.781	96.044
---	.0394	1.	55/64	.859	21.828	---	2.2835	58.	3-13/16	3.8125	96.838
3/64	.0469	1.191	---	.8661	22.	2-5/16	2.312	58.738	---	3.8189	97.
---	.059	1.5	7/8	.875	22.225	---	2.3228	59.	3-27/32	3.844	97.631
1/16	.062	1.586	57/64	.8906	22.622	2-11/32	2.344	59.531	---	3.8583	98.
5/64	.0781	1.984	---	.9055	23.	---	2.3672	60.	3-7/8	3.875	98.425
---	.0787	2.	29/32	.9062	23.019	2-3/8	2.375	60.325	---	3.8976	99.
3/32	.094	2.381	59/64	.922	23.416	---	2.4016	61.	3-29/32	3.9062	99.219
---	.0964	2.5	15/16	.9375	23.813	2-13/32	2.406	61.119	---	3.9370	100.
7/64	.109	2.778	---	.9449	24.	2-7/16	2.438	61.913	3-15/16	3.9375	100.013
---	.1181	3.	61/64	.953	24.209	---	2.4409	62.	3-31/32	3.969	100.806
1/8	.125	3.175	31/32	.969	24.606	2-15/32	2.469	62.706	---	3.9764	101.
---	.1378	3.5	---	.9843	25.	---	2.4803	63.	4	4.000	101.600
9/64	.141	3.572	63/64	.9844	25.003	2-1/2	2.500	63.500	4-1/16	4.062	103.188
5/32	.156	3.969	1	1.000	25.400	---	2.5197	64.	4-1/8	4.125	104.775
---	.1575	4.	---	1.0236	26.	2-17/32	2.531	64.294	---	4.1338	106.
11/64	.172	4.366	1-1/32	1.0312	26.194	---	2.559	65.	4-3/16	4.1875	106.363
---	.177	4.5	1-1/16	1.062	26.968	2-9/16	2.562	65.068	4-1/4	4.250	107.950
3/16	.1875	4.763	---	1.063	27.	2-19/32	2.594	65.881	4-5/16	4.312	109.538
---	.1969	5.	1-3/32	1.094	27.781	---	2.5964	66.	---	4.3307	110.
13/64	.203	5.159	---	1.1024	28.	2-5/8	2.625	66.675	4-3/8	4.375	111.125
---	.2163	5.5	1-1/8	1.125	28.575	---	2.638	67.	4-7/16	4.438	112.713
7/32	.219	5.556	---	1.1417	29.	2-21/32	2.656	67.469	4-1/2	4.500	114.300
15/64	.234	5.953	1-5/32	1.156	29.369	---	2.6772	68.	---	4.5275	115.
---	.2362	6.	---	1.1811	30.	2-11/16	2.6875	68.263	4-9/16	4.562	115.888
1/4	.250	6.350	1-3/16	1.1875	30.163	---	2.7165	69.	4-5/8	4.625	117.475
---	.2559	6.5	1-7/32	1.219	30.956	2-23/32	2.719	69.056	4-11/16	4.6875	119.063
17/64	.2636	6.747	---	1.2205	31.	2-3/4	2.750	69.850	---	4.7244	120.
---	.2756	7.	1-1/4	1.250	31.750	---	2.7559	70.	4-3/4	4.750	120.650
9/32	.281	7.144	---	1.2598	32.	2-25/32	2.781	70.6439	4-13/16	4.8125	122.238
---	.2953	7.5	1-9/32	1.281	32.544	---	2.7953	71.	4-7/8	4.875	123.825
19/64	.297	7.541	---	1.2992	33.	2-13/16	2.8125	71.4376	---	4.9212	125.
5/16	.312	7.938	1-5/16	1.312	33.338	---	2.8346	72.	4-15/16	4.9375	125.413
---	.315	8.	---	1.3386	34.	2-27/32	2.844	72.2314	5	5.000	127.000
21/64	.328	8.334	1-11/32	1.344	34.131	---	2.8740	73.	---	5.1181	130.
---	.335	8.5	1-3/8	1.375	34.925	2-7/8	2.875	73.025	5-1/4	5.250	133.350
11/32	.344	8.731	---	1.3779	35.	2-29/32	2.9062	73.819	5-1/2	5.500	139.700
---	.3543	9.	1-13/32	1.406	35.719	---	2.9134	74.	---	5.5118	140.
23/64	.359	9.128	---	1.4173	36.	2-15/16	2.9375	74.613	5-3/4	5.750	146.500
---	.374	9.5	1-7/16	1.438	36.513	---	2.9527	75.	---	5.9055	150.
3/8	.375	9.525	---	1.4567	37.	2-31/32	2.969	75.406	6	6.000	152.400
25/64	.391	9.922	1-15/32	1.469	37.306	---	2.9921	76.	6-1/4	6.250	158.750
---	.3937	10.	---	1.4691	38.	3	3.000	76.200	---	6.2992	160.
13/32	.406	10.319	1-1/2	1.500	38.100	3-1/32	3.0312	76.994	6-1/2	6.500	165.100
---	.413	10.5	1-17/32	1.531	38.894	---	3.0315	77.	---	6.6929	170.
27/64	.422	10.716	---	1.5354	39.	3-1/16	3.062	77.788	6-3/4	6.750	171.450
---	.4331	11.	1-9/16	1.562	39.688	---	3.0709	78.	7	7.000	177.800
7/16	.438	11.113	---	1.5748	40.	3-3/32	3.094	78.581	---	7.0666	180.
29/64	.453	11.509	1-19/32	1.594	40.481	---	3.1102	79.	---	7.4803	190.
15/32	.469	11.906	---	1.6142	41.	3-1/8	3.125	79.375	7-1/2	7.500	190.500
---	.4724	12.	1-5/8	1.625	41.275	---	3.1496	80.	---	7.8740	200.
31/64	.484	12.303	---	1.6535	42.	3-5/32	3.156	80.169	8	8.000	203.200
1/2	.492	12.5	1-21/32	1.6562	42.069	3-3/16	3.1875	80.963	---	8.2677	210.
---	.500	12.700	1-11/16	1.6875	42.863	---	3.1890	81.	8-1/2	8.500	215.900
---	.5118	13.	---	1.6929	43.	3-7/32	3.219	81.756	---	8.6614	220.
33/64	.5156	13.097	1-23/32	1.719	43.656	---	3.2283	82.	9	9.000	228.600
17/32	.531	13.494	---	1.7323	44.	3-1/4	3.250	82.550	---	9.0551	230.
35/64	.547	13.891	1-3/4	1.750	44.450	---	3.2677	83.	---	9.4488	240.
---	.5512	14.	---	1.7717	45.	3-9/32	3.281	83.344	9-1/2	9.500	241.300
9/16	.563	14.288	1-25/32	1.781	45.244	---	3.3071	84.	---	9.8425	250.
---	.571	14.5	---	1.8110	46.	3-5/16	3.312	84.1377	10	10.000	254.001
37/64	.578	14.684	1-13/16	1.8125	46.038	3-11/32	3.344	84.9314	---	10.2362	260.
---	.5906	15.	1-27/32	1.844	46.831	---	3.3464	85.	---	10.6299	270.
19/32	.594	15.061	---	1.8504	47.	3-3/8	3.375	85.725	11	11.000	279.401
39/64	.609	15.478	1-7/8	1.875	47.625	---	3.3858	86.	---	11.0236	280.
5/8	.625	15.875	---	1.8896	48.	3-13/32	3.406	86.519	---	11.4173	290.
---	.6299	16.	1-29/32	1.9062	48.419	---	3.4252	87.	---	11.8110	300.
41/64	.6406	16.272	---	1.9291	49.	3-7/16	3.438	87.313	12	12.000	304.801
---	.6496	16.5	1-15/16	1.9375	49.213	---	3.4646	88.	13	13.000	330.201
21/32	.656	16.669	---	1.9685	50.	3-15/32	3.469	88.106	---	13.7795	350.
---	.6693	17.	1-31/32	1.969	50.006	3-1/2	3.500	88.900	14	14.000	355.601
43/64	.672	17.066	2	2.000	50.800	---	3.5039	89.	15	15.000	381.001
11/16	.6875	17.463	---	2.0079	51.	3-17/32	3.531	89.694	---	15.7480	400.
45/64	.703	17.859	2-1/32	2.03125	51.594	---	3.5433	90.	16	16.000	406.401
---	.7067	18.	---	2.0472	52.	3-9/16	3.562	90.4877	17	17.000	431.801
23/32	.719	18.256	2-1/16	2.062	52.388	---	3.5827	91.	---	17.7165	450.
---	.7283	18.5	---	2.0866	53.	3-19/32	3.594	91.281	18	18.000	457.201
47/64	.734	18.653	2-3/32	2.094	53.181	---	3.622	92.	19	19.000	482.601
---	.7480	19.	2-1/8	2.125	53.975	3-5/8	3.625	92.075	---	19.6850	500.
3/4	.750	19.050	---	2.126	54.	3-21/32	3.656	92.869	20	20.000	508.001
49/64	.7656	19.447	2-5/32	2.156	54.768	---	3.6614	93.	---	---	---

Kind of material	International ISO		Germany		USA		USSR GOST		Great Britain BS		Japan JIS		France AFNOR		Sweden MNC		Remarks			
	material standard	Designation	DIN 17007 Quality nr.	material standard	Designation	Designation	material standard	Designation	material standard	Designation	material standard	Designation	material standard	Designation	material standard	Designation				
Cast iron	R185	GR25	0.8025	1691	GG25	-	A48	40D	1412	SCh26-48	1452	Gr.17	G5601	FC25	NFA32-101	F125D	NMC-705E	01 25-00		
	R1083	Gr.400-12	0.7040	1693	GGG-40	-	A536	60-40-18	7293	VC 42-12	2789	Gr.420/12	G5502	FCD40	NFA32-201	FGS400-12	MNC-708	0717-02		
	R1083	Gr.800-3	0.7060	1693	GGG-60	-	A536	60-55-06	7293	VC 60-2	2789	Gr.600/3	G5502	FCD60	NFA32-201	FGS800-3	MNC-706	0732-03		
	5922	W40-05	0.8040	1692	GTW-40-05	-														
	2692	SNiCr 203	0.7861	1694	GGG-Ni-Cr20.3	-	A439	D-2B			3488	S-NiCr 20.3							Ni-Resist D-2B	
Cast Steel			0.8025	1691	GG25	-	A126	CL B			1452	GR 220								
			1.0482	17155	18 Mn5		A105				1503	221-480								
			1.0819	17245	GS-C25	-	A216	Gr.WCB-A			3100	Gr.B7	G5501	SC48		A48-M3S				
	D4991	C23-45BL	1.1142	(SEW695)	GS-CK16		A352	Gr.LCB					G5152	SCPL-1						
			1.0044	17100	St 44-2		A-181	CL90			1503	221-436								
Cast Alloy Steel			1.0044	17100	St 44-2		A-36			4360	43 B									
			1.4059	17445	G-X22CrNi 17	(431)	A743	CA 40			3146	ANC-2				Z20CN17.2M				
			1.4308	17445	G-X6 CrNi18.9	(304)	A743	CB 30	07CH18Ni9		1504	304C15	G5121	SCS13		Z6CN18.10M				
	DP4991	C38 C	1.4408	17445	G-X6 CrNiMo 18.10	(316)	A743	CF 8C			3100	316C18	G5121	SCS14		Z6CND18.12M				
			1.4500	(SEW410)	G07 NiCrMoCuNb 25.20		A296	CN 7M								Z3NCDU25.20M				
Alloy Steel			1.4539		X2NiCrMoCu25.20.9											Z1NCDU25.20		2562		
	R683-XII		1.4541	17440	X10CrNiTi18.9	321					1448	321S12					1503-821	321S31	SIS2337	
	R683-XII	11	1.4301	17440	X5CrNi18.9/2	304/L	A276	304/L	5632	O1KH18Ni10	970/4	304 S15	G4303	SUS304	NFA35-573	Z6CN18.09	MNC-900E	2332-02	SIS2333/52	
	R683-XII	20	1.4401	17440	X5CrNiMo18.10/X2	316/L	A276	316/L	5632	1X18H1	970/4	316 S16	G4303	SUS316	NFA35-573	Z6CND17.11	MNC-900E	2347-02	SIS-2342/53	
			1.0405	17175	ST 45-8	SMLS	A106	GRB			3802	HFS 410							BS 3802 HFS27	
Bronze			1.7335	17175	13CrMo44	335P11	A182	F11			1501-820	GR27					1503-821	480		
	B33604HF820		1.7380	17175	10CrMo910	335P22	A182	F22			1501-822	GR31					1503-822	580		
	3804HF822																			
	1338	CuPb5Sn5Zn5	2.109601	1705	G-6uSn5Zn5Pb		B62	C.836.00			1400	LG2	H5111	BC6	NFA53-707	CuPb5Sn5Zn5	145204	52-04-03	RG 5	
	1338	SuSn7Pb7Zn3	2.1096.01/02/03	1705	G-CuSn7Zn3Pb		B584	C.932.00			1400	LG4	H5111	BC7	NFA53-707	CuS7Pb6Zn4		5444		RG7
Alum Bronze	1338	CuSn10Zn2	2.1096.01	1705	G-CuSn10Zn		B584	C.905.00			1400	G1	H5111	BC3	NFA53-707	CuSn6	145468			RG 10
	1338	G-CuAl10Fe5Ni5	2.0975.01/2/3/4	1714	G-CuAl10Ni		B148	C.955.00			1400	AB1/AB2	H5114	ALC3	NFA53-708	CuAl9Ni5Fe				
Alum Bronze	428	CuAl10Fe5Ni5	2.0966.97	17665/17672	CuAl10Ni-Fe5		B171	628.000			2672	CA104								
	428	CuAl10Fe5Ni5	2.0966.98	17665/17672	CuAl10Ni-F75															
Condenser Tube			1.0315	17177	SL37-8/42.8		A179	Gr A/C			3059	GERW320								
			1.0309/05	17175	St 35.4/35.8		A179				3808	CFS 320								
			1.0305	17175	St 35-8		A192				3059	320								
Cu-Ni-Alloy Steel	428		2.4375	17743	NiCu30Al	(FED.SPED 0 0-N-286 CLASSA)					3078 NA 18								Monel K500	
	429		2.0835.01	17658	G-CuNi30															
Bolts/Nuts			1.7225	17200	A2CrMo4		A 193	Gr B7			1506-821	A Cont T								
			1.1181	17240	C35		A 194	GR2H			1506-182	Cont TX								
			1.4301	17440	X5CrNi189		A193	GR6			1506-801	B								
Carbon Steel	630	Fe360B	1.0037	17100	S137-2		A263	GrD	380	Vst3SP4	4380	40B		NF A35.501	E24-2	SIS	1650	EN25-72Fe360		
	1052	Fe590-2	1.0060	17100	S160-2				380	S16SP3	4380	55C		NF A35.501	A60			EN25-72Fe590-2		
Rubber	R1829	FPM		3780	FP		D418-72a	FKM												
	R1829	NBR		3780	NB		D418-72a	NBR												
	R1829	EPDM		3780	EPDM		D418-72a	EPDM												

ABBREVIATIONS

MATERIALS

AI	all iron
BR, BRZ	bronze
BT	bronze trim
CI	cast iron
CR	chromium
CR 13	type 410 stainless steel, 13% CR
CS	cast steel
CUNI	coppernickel (90/10 & 70/30)
DI	ductile iron
EPT	ethylene propylene ter polymer
FS	forged steel
HF	stellite face (hard face)
IBBM	iron body bronze mounted (trim)
M	monel metal
MO	molybdenum
MI	malleable iron
MT	monel trim
NBR	buna-n rubber
NICU	nickel copper alloy (monel)
SS	stainless steel
TEF, TFE, T	teflon
UT	universal trim (CR-13)
18-8S	type 304 stainless steel
18-8S, MO	type 316 stainless steel

RATINGS

CWP	cold working pressure
S, SP	steam, steam pressure
WSP	working steam pressure
WP	working pressure
WOG, OWG	water oil gas pressure

SOCIETIES

ABS	American Bureau of Shipping
AISI	American Iron & Steel Institute
API	American Petroleum Institute
ASA	American Standards Association
ANSI	American National Standards Institute
ASME	Am. Society of Mechanical Engineers
ASTM	Am. Society for Testing & Materials
AWWA	American Water Works Associaton
BS	British Standard
DIN	Deutscher Industrial Norm
ISO	International Standards Organization
JIS	Japanese Industrial Standard
Mil-Spec	Military Standards
MSS	Manufacturers Standardization Society
SAE	Society of Automotive Engineers

STEM DESIGN

NRS	non-rising stem
OS&Y, OSY	outside screw and yoke, rising stem
RS	rising stem

BONNET DESIGN

BB	bolted bonnet-
SB, TB	screwed, threaded bonnet
UB	union bonnet
WB	welded bonnet

END CONNECTIONS

BW, BWE	buttweld ends
FE, FLG	flanged ends
FF	flat face
FFD	flanged, faced and drilled
RF	raised face
SW, SWE	socketweld ends
SCR, SCRD, SE	screwed ends
SB, S/B	silbrazed
SJ	solder joint (tube size)
WS	walseal, face-fed

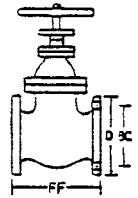
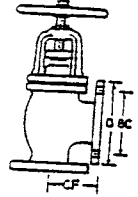

MEASUREMENTS

BC, BCD	bolt circle diameter, pitch
BHN	brinell hardness number
C-F	center to face
F-F	face to face, building length
IPS	iron pipe size
KG	kilogram
M	meter
MM	millimeter
NPS	nominal (name) pipe size
PCD	pitch circle or bolt circle diameter
SCH	schedule
SMLS	seamless
STD	standard, Sch 40 (through 10" IPS)
XH, XS	extra heavy, Sch 80 (through 8" IPS)
XXH, XXS	double extra/heavy

THREADS

BSP, BSPT	British Standard Thread (tapered)
BSPP	British Standard Thread (parallel)
IPT, TIPT	iron pipe thread, tapered IPT
SIPT	straight iron pipe thread
NH, NST	National Hose, Standard (Hose) Thread
NPSH	National Pipe Straight Hose (SIPT)
NPT	National Pipe Thread

VALVE TRIM

CR 13/HF (Type 410), UT: 13% chromium stainless steel stem, disc faces with hard faced (stellite) seat faces. Recommended for oil and oil vapor services. Also used for steam, water, air and gas services in globe, angle and swing check valves, for temperatures to 950°F.

Bronze stem, disc faces and seat rings. Used primarily in fresh and salt water services. ASTM B-62 bronze used for temperatures to 450°F, and ASTM B-61 bronze to 550°F.

Type 316 (18% chromium, 8% nickel with molybdenum) stainless steel stem, disc faces, and seat rings. Recommended for corrosive service.

Monel (65% Ni 35% Cu) stem, disc faces, and seat rings. Recommended for highly corrosive marine services.

Full Stellite 13% chromium stainless steel stem with stellite hard faced seats and disc facing. Used for severe steam service.

VALVE FLOW CHARACTERISTICS

Valves are the controlling element in any piping system and have four primary functions:

1. Starting and stopping flow.
2. Regulating or throttling flow by change of direction or restriction.
3. Preventing backflow.
4. Relieving and reducing or regulating pressure.

STARTING & STOPPING

GATE VALVES

Gate valves are used when minimal pressure drop through the valve is required. They are designed to permit a straight, full and free flow, or no flow at all. Gate valves are normally wide open or completely closed.

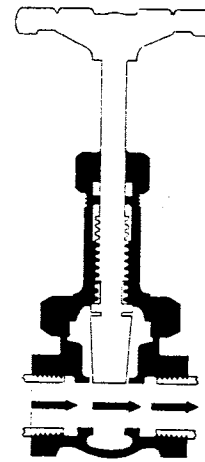

Gate Valves

PLUG VALVES

Like gate valves, plug valves are used primarily for non-throttling, on-off service. They require minimum installation space and utilize a simple and quick "quarter-turn" design. The tapered plug, offers easy actuation and tight shutoff.

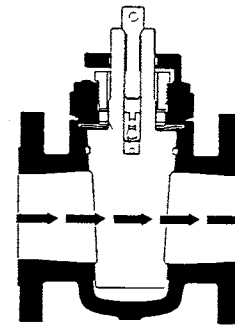

Plug Valves

BALL VALVES

Ball valves offer a quick-operating, self-sealing design that is not dependent on torque for seating force. Tight shutoff is accomplished through the use of elastomer or elastomer seat rings. The most common of these seating materials are synthetic rubber, teflon, and nylon. Although maximum temperatures are limited by these materials, ball valves offer compact, inexpensive design and smooth flow through the port. Some pressure drop is experienced through conventional ball valves, which have reduced ports (full port designs are available).

THROTTLING

GLOBE VALVES

Globe valves are used for efficient throttling (modulating) control and regulation of flow between all-on and all-off position and for services requiring frequent operation or positive shutoff. Disc seating is parallel to the line of flow. The change in direction of fluid flow through a globe valve produces significant resistance and pressure drop.

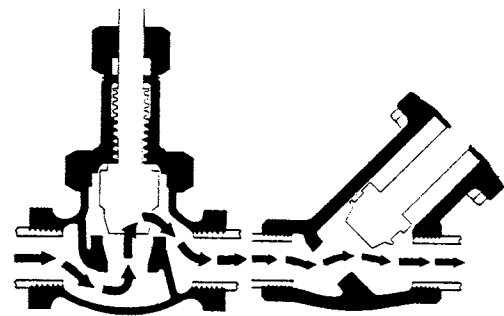

Globe Valves Y Globe

ANGLE VALVES

Angle valves have the same basic features as globe valves. The fluid flow through the angle valve, however, makes a 90° turn. Angle valves offer less resistance than globe valves with elbows which they are intended to replace. The use of angle valves thus reduces the number of joints in a line and saves installation time.

BUTTERFLY VALVES

Butterfly valves utilize simple 90° disc-stem operation for larger throttling applications. They can also be used as shutoff valves, although some pressure drop is experienced through the valve opening. These valves offer initial low cost, simple installation and easy actuation. The usefulness of butterfly valves has increased with the development of elastomer liners and backup rings in the body which provide tight shutoff. Buna-N, the most common liner material, is not suitable for steam service. Body styles include wafer, lug wafer, and flanged designs.

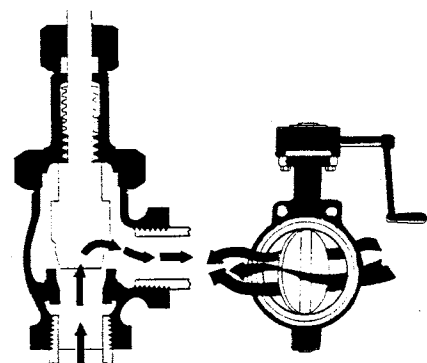

Angle Valves Butterfly

VALVE FLOW CHARACTERISTICS

BACKFLOW PREVENTION

SWING CHECK VALVES

All check valves offer quick and automatic reactions to flow changes. The pressure of the fluid flow keeps the valve open, and any reversal of flow closes it. Swing check valves provide minimum resistance to normal flow. They are used for low velocity services with infrequent changes of direction. They are generally utilized inline with gate valves due to compatible flow characteristics.

Y-PATTERN SWING CHECK VALVES

Y-Pattern swing check valves offer slightly more resistance to flow, but may be installed in both horizontal and vertical lines with upward flow. The 45° seat aids in backseating under low pressure conditions.

LIFT CHECK VALVES

Lift check valves are used for services with frequent changes of direction, and for increased flow resistance and positive backflow prevention. They are utilized inline with globe and angle valves due to compatible flow characteristics. Available for horizontal or vertical service.

WAFER CHECK VALVES

Wafer check valves are generally light and easy to install. They are designed for quick closing at zero flow and are utilized with gate and butterfly valves. Wafer checks come in a variety of designs: swing type, tilt disc, lift type and double disc. Shown page 77.

BALL CHECK VALVES

This design is favored in handling highly viscous fluids.

AIR COMPRESSOR CHECK VALVES

A special design for the slamming service inherent in air compressor systems. See page 12.

PUBLIC HEALTH VALVES

Describes valves for use in water systems, sanitary and drinking, where backflow into supply must be controlled. Shown page 86.

STOP CHECK, SCREW DOWN NON-RETURN VALVES

Feature in globes and angles allowing for backflow prevention.

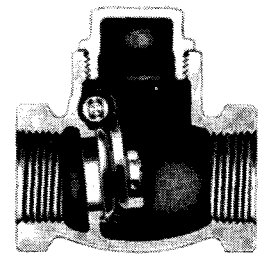

Swing Check

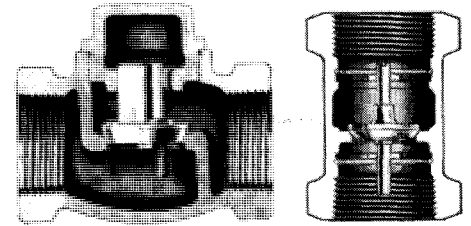

Horizontal Lift Check Vertical Lift Check

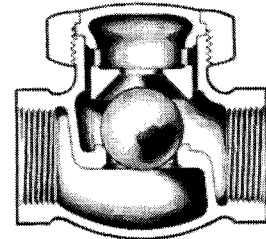

Horizontal Ball Check

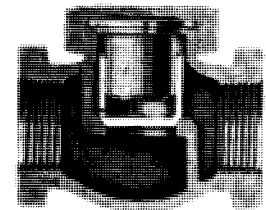

Air Compressor Check

PRESSURE / TEMPERATURE RELATIONSHIP

Valves are rated for a variety of pressure levels. There is a dynamic and inverse relationship between pressure and temperature such that as temperatures elevate, pressure holding values diminish. Thus pressure as rated will be joined with a temperature in most valve ratings, and a valve will hold less pressure at higher temperature and will likely hold increased pressure at lower temperatures although this is not strictly defined.

VALVE DESIGN

BODY-BONNET CONNECTIONS

Threaded bonnets are generally applicable only for non-critical services such as plumbing and heating shutoff in low pressure lines. This design is the simplest and least expensive, but tends to distort over time making reconditioning difficult.

Critical services, involving applications which could endanger persons or property, require union bonnets, bolted bonnets, or pressure seal bonnets. The union bonnet design offers easy coupling and uncoupling, and is therefore favored where the use of soft metal or composition discs requires periodic replacement. Bolted and pressure seal designs are utilized with larger sizes and higher pressure applications.

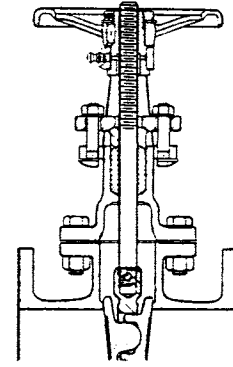

Outside Screw and Yoke
Rising Stem

STEM CONSTRUCTION

RISING STEM - OUTSIDE SCREW AND YOKE

This design keeps stem threads outside the body in order to avoid the damaging effects of high temperature, corrosives, and inline solids inside the valve. When the handwheel is turned, the stem rises as the yoke bushing engages the stem threads. External threads afford easy lubrication, but care must be taken to protect threads from damage.

RISING STEM - INSIDE SCREW

This stem design is most commonly used in bronze gate valves. Since the handwheel and stem both rise, adequate clearance for operation must be provided. The stem and handwheel position indicates the position of the disc inside the valve. Care must be taken to protect the stem externally.

NON-RISING STEM - INSIDE SCREW

This design requires minimum headroom for operation. Since the stem does not travel vertically, packing wear is reduced. Heat, corrosives, and inline solids may damage stem threads, however, and cause excessive wear. It is also impossible to visually determine the position of the disc, unless valve is fitted with an indicator device.

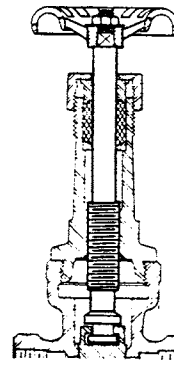

Inside Screw, Rising
Stem and Handwheel

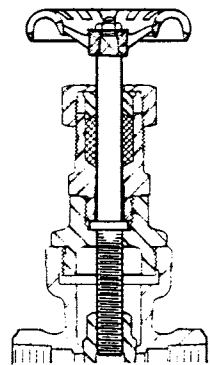

Inside Screw
Non-Rising Stem

DISC CONSTRUCTION

GATE VALVES

The solid wedge disc is the most widely used design in gate valve construction due to its simplicity and versatility. Gate valves with this disc may be installed in any position. The solid wedge disc is particularly suitable for steam service where a split or double disc would chatter.

Flexible discs are wedge-seated with disc faces joined at the center by a hub. This design enables the disc faces to independently compensate for variable temperatures and pressures, and allows valve operation at lower torques.

Split disc, double disc or parallel slide is especially suitable for use with non-condensing gases and liquids at normal temperatures. Disc halves are forced outward against the body seats by a disc spreader when closing the valve, but only after the disc assembly has been lowered into seating position. In opening the valve, pressure on the disc is relieved before being raised to avoid wear on body seats. Valves with this disc design are recommended for vertical installation only.

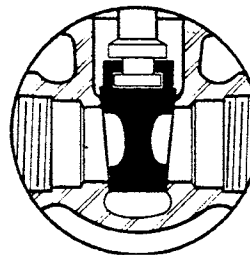

Solid Wedge

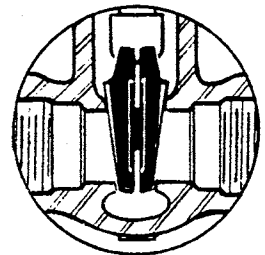

Flexible Wedge

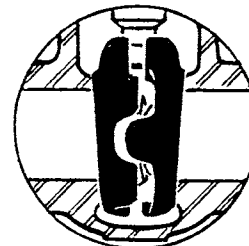

Double Disc

VALVE DESIGN

GLOBE VALVES

Discs and seats in most globe valves can be repaired or replaced without removing the valve body from the line.

Teflon or composition discs are especially suitable for tight shutoff of gases. They are also suitable for most general services such as steam, water, and gasoline. Solid particles may be embedded in service without effecting tight shutoff. Teflon or composition discs are not recommended for severe throttling applications.

Conical discs can be reground and so are desirable for services that result in deposit build up on seating services. This design is usually found in bronze valves with bronze or other corrosion resistant seats.

Tapered plug discs have wider seating contact than the conical design, and are suitable for severe throttling applications.

The needle-type disc is used for exacting flow regulation, usually in instrumentation.

The screw down check-type disc, commonly referred to as "stop check," permits globe and angle valves to serve as check valves. In the open position, the disc slides freely on the stem, and will seat to stop or check reversal of flow.

END CONNECTIONS

THREADED

Tapped with female taper pipe threads, threaded end connections are the least expensive and lightest in weight.

SOCKETWELD

Socketweld ends are pipe size and are recommended with high temperature and pressure applications where absolutely tight, leakproof connections must be maintained over a long period.

BUTTWELD

Like socketweld the butt weld end is a leakproof connection suitable for severe and high pressure applications.

FLANGED

Flanged ends provide a strong, tight joint and are generally used for line sizes above 3" that must be assembled and disassembled frequently.

SOLDER

Solder ends are socket ends for tube size applications and mostly used with Types K, L, and M copper tubing for low pressure services. Maximum temperature applications may not exceed 250° F due to the low melting point of solder.

SILBRAZE

Silbrazed ends are used with IPS sized copper or coppernickel pipe. The brazed silver solder joint is superior to a standard soldered joint, having higher pressure and temperature holding properties.

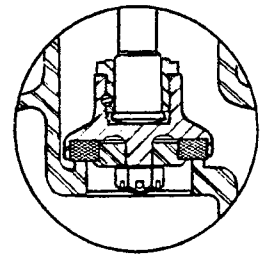

Teflon / Composition Disc

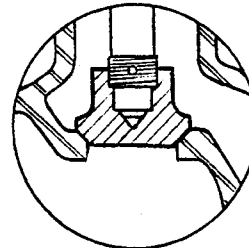

Conical Disc

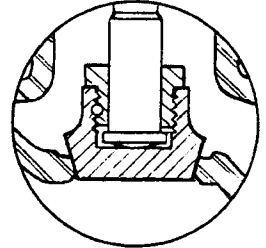

Plug Disc

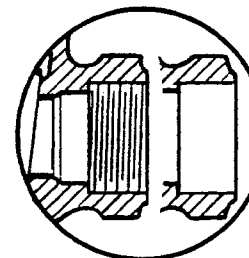

Threaded & Socketweld

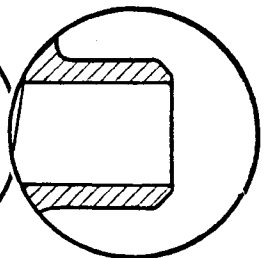

Buttweld

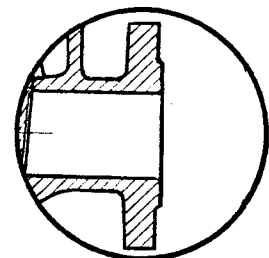

Flanged

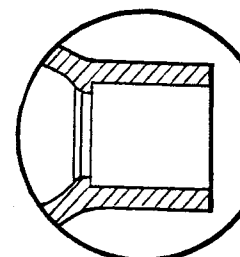

Solder Joint

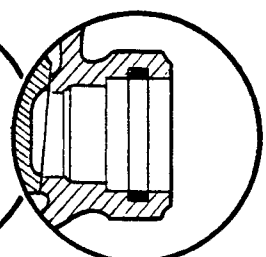

Silbrazed

INDEX

Figure numbers are presented for many of our items-however we are prepared to supply based upon your own descriptions or with reference numbers from any industry catalog.

GATE VALVES

	PAGE
Bronze	7-21,34,133
Cast Iron	25-26,34-35
Ductile Iron	39,44
Cast Steel	36,39,44
Forged Steel	48
Metric	123-136
Stainless	53-54,68

GLOBE, ANGLE & STOP CHECK VALVES

Bronze	9-21,133
Cast Iron	27-28,35,64,75,133
Ductile Iron	28,32,75,133
Cast Steel	40-44,75
Forged Steel	49-52,64
Metric	123-136
Stainless	55-56

CHECK VALVES

Bronze	11-14,24,67,86,133
Cast Iron	29-30,35,67
Ductile Iron	33
Cast Steel	43-47,67
Forged Steel	50
Metric	123-126
Stainless	57-58,67

BALL VALVES 65,161

BUTTERFLY VALVES 61-63

HOSE VALVES 21-22,79

METRIC VALVES 123-136

MISCELLANEOUS VALVES

Actuation	60,63
Backflow Preventors	86
Bellmouths	75,186
Blowdown Valves	51-52,84
Boiler Valves	35,41,51-52,83,156
Cocks & Plug Cocks	66,125,133
Control Valves	73,166
Cross Valves	75,86
Deck Drains & Deck Access Boxes	76,172-173
Deck Wash Valves	22
Diaphragm Valves	69
Edwards® Valves	44,51-52
Ejectors/Eductors	75
Emergency Shut-off	84
Flame Screens,Arrestors	70
Fire Valves	21-22,79
Flush Valves	87,174
Foot Valves	86,99
Gaskets & Packing	88,105
Gage Valves	82
Handwheels	60
Hi-Lift Cargo Angle Valves	75
High Pressure Valves	14,43-44,48-52
Hose Valves,Thread Chart	21-22,79
Knife Gate	68
Line Blind & Spectacle Blind	74
Liquid & Boiler Gauges	83
Manifolds	75
Marine Equipment	88
Modifications	59-60
Needle Valves	82
Operators, Options	59-60
Packing & Gaskets	88
Plug Valves	66,125,160
Pressure Vacuum Relief Valves	70
Pressure Reducing Valves	73,164,166
Pressure Seal	43-44
Public Health Valves	86-87
PVC Valves	99

Quick Open & Close Valves	84
Reducers/Regulators	72-73,165-166
Refrigeration Valves	72
Relief & Safety Valves	71,162
Rockwell Edwards® Valves	44,51-52
Safety & Relief Valves	71
Scupper Valves	85,136,175
Sight Feed & Sight Flow	83
Solenoid Valves	84,176
Steam Traps	80,170
Storm Valves	85,136,175
Strainers	81,163
Temperature Regulators	72,167
Testing & Certifications	59
Tomoe® Butterfly	62,135
Union End Valve	13,143-145,153
Vent Check Valves	77
Wafer Checks	67
Water Gauges	83
Y-Globe Valves	43-44,51-52,86

PIPE AND TUBING 109-114,191-193

Hangers,Clamps	116-118
Weld Rings	116
Insulation	116
Couplings	117-118

FITTINGS & FLANGES 89-107

Aluminum, Aluminum Brass	89-93,104
Black Iron	87-90
Brass,Bronze	89-91
Buttweld	92-93
Chrome Plated	90,101,103
Chrome-Moly	91,93
Compression & Bite Type	101,103,107,139
Copper	102
Coppernickel	90-93,180-181,189
Deck Sleeve Penetration	105,107,117-118
Diacoup Couplings	105,117
Dresser® Couplings	105,117
Expansion Joints	115
Fasteners	88
Fiberglass, FRP	100
Flanges ANSI	94,97,102,189-190
Metric	98,140
Dimension Charts	197-203
Flanged Fittings	100
Flare	101,103,139
Forged Steel	90-91
Galvanized	89-91
Grip Couplings, Normaconnect	107,118
High Pressure	90-91
Hose Fittings,Thread Chart	22,78-79
Malleable Iron	89-90
Marine Equipment	88
Metric	98,103-104,107,125
Navy Mil-Spec	177-190
Nipples	90,95
Olets,Bosses	96,184
PVC,CPVC	99
Quick Connect Fittings	106,173
Silbraz	94,177-179
Socket Weld	91,185
Spool Piece	100
Stainless	89-93
Stub Ends	93,97
Tanker Unions	104
Threaded	89-90,185
Tube Fittings	101,104
Weld,Braze,Thd Olets	96
Weld & Dimensions	91-93
Wrot Copper	102
Yorcalbro	104

METALS PROFILES PLATE 119-121

NAVY INDEX MIL-SPEC 141,143-194

DATA INFO CONVERSIONS 122,195-214

NOTES

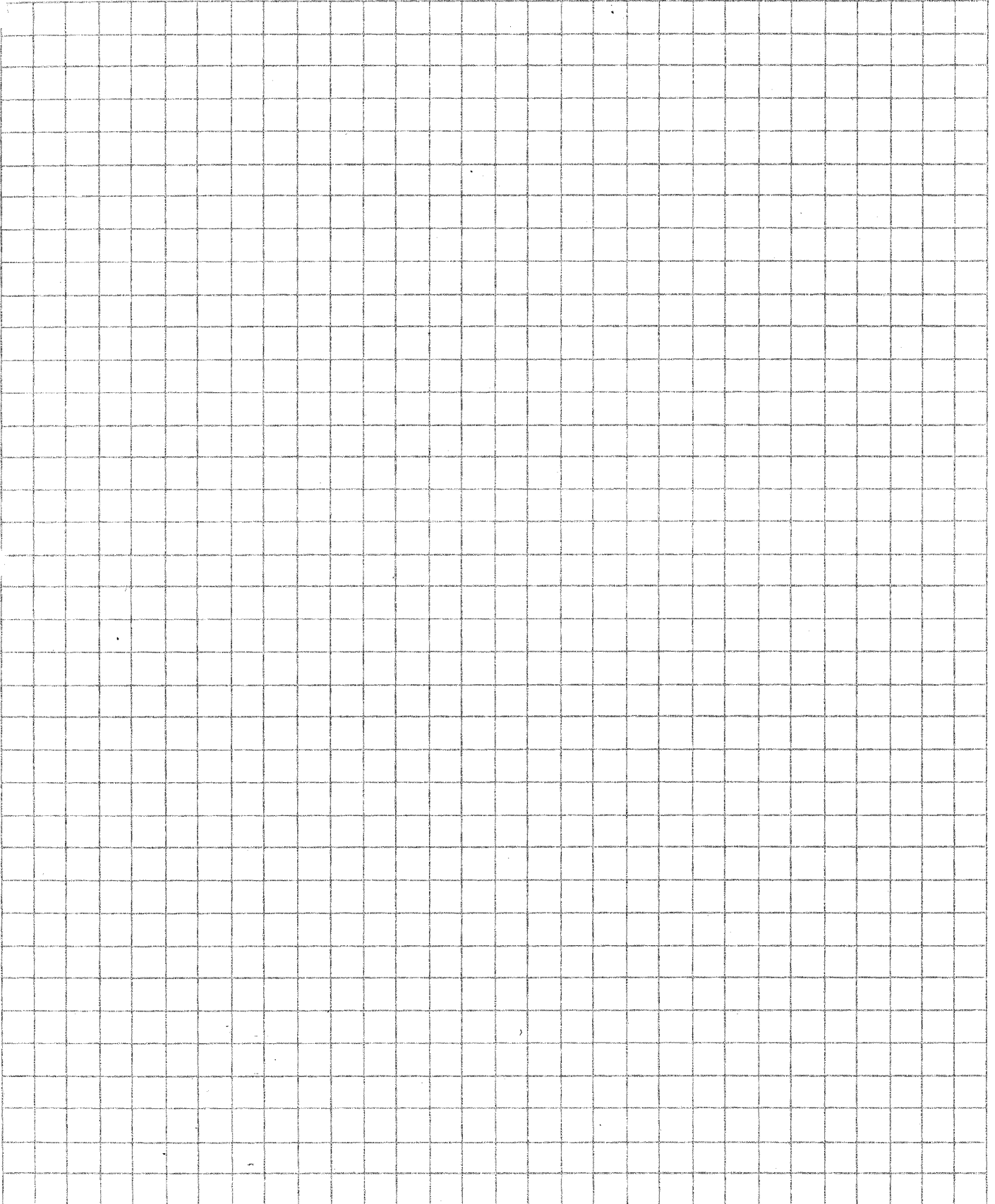

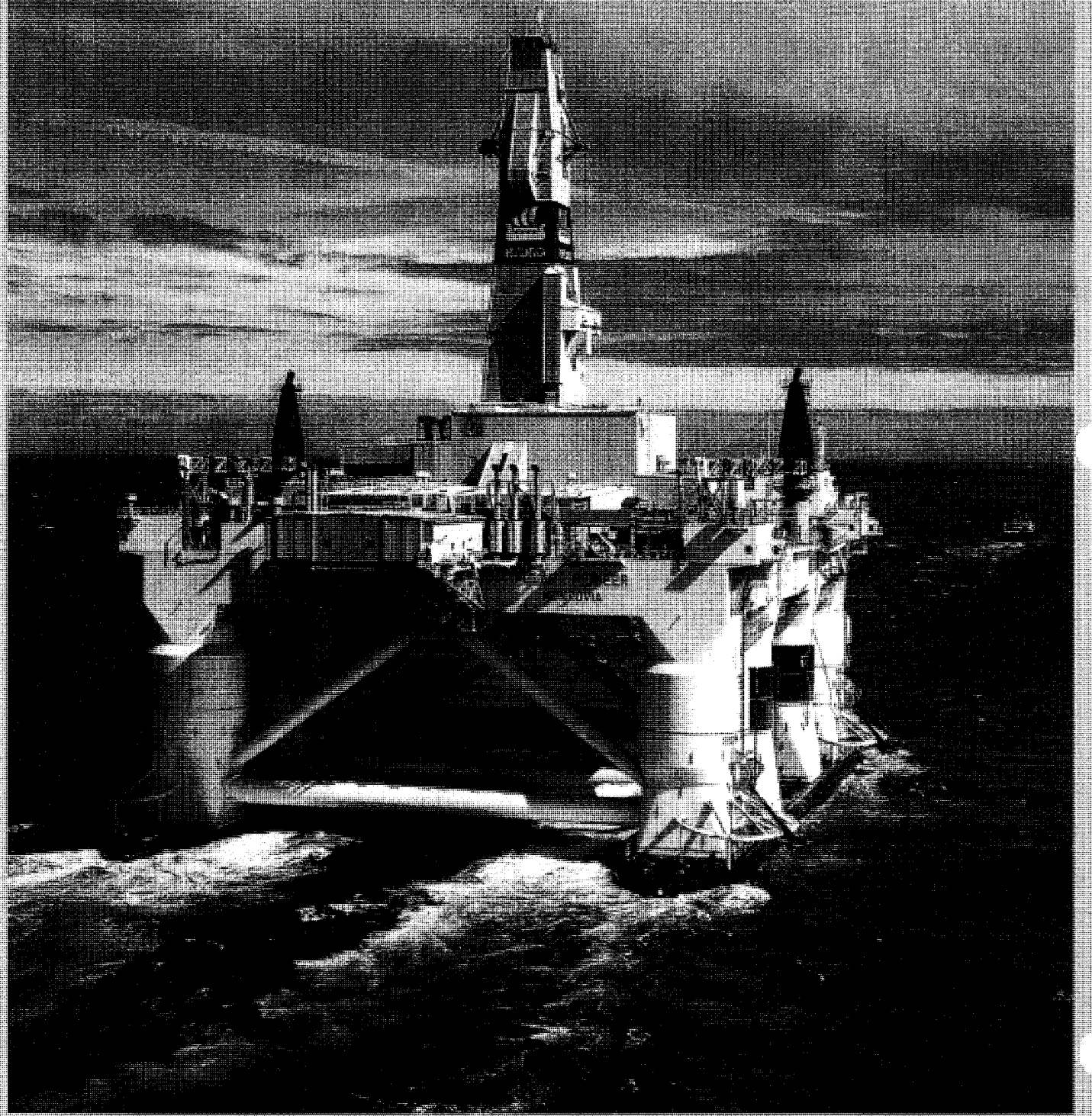



CHOOSE W&O.

- We are there when you need us.
- North American footprint – 16 strategically located branches.
- 40 years as a reputable partner.
- Over \$45 Million in inventory.
- Automation experts with in-house design and fabrication.
- We represent top brands with the required certifications and registrations.
- Largest North American distributor of pipe, valves, fittings, and automation.
- Valve Services – ship checks and Engineered Solutions troubleshooting.
- Delivering new technologies and monitoring regulations to better serve our customers.
- Part of Pon, an \$8 Billion International Sales & Service Company.

LOCATIONS

Alabama

Mobile
4766 Rangeline Rd.
Mobile, AL 36619
Tel: 251.433.2816
mobile.al@wosupply.com

California

San Diego
VAC
2390 Boswell Rd.
Ste. 100
Chula Vista, CA 91914
Tel: 619.656.7420
vac@wosupply.com

Long Beach
800 West 14th St.
Long Beach, CA 90813
Tel: 562.435.6359
longbeach.ca@wosupply.com

Florida

Jacksonville - Corp. Office
2677 Port Industrial Drive
Jacksonville, FL 32226
Tel: 904.354.3800
corporate@wosupply.com

Ft. Lauderdale
3333 S.W. 2nd Ave.
Ft. Lauderdale, FL 33315
Tel: 954.462.8008
ftlauderdale.fl@wosupply.com

Tampa

1902 B 43rd St. N.
Tampa, FL 33605
Tel: 813.248.4139
tampa.fl@wosupply.com

Louisiana

New Orleans
4800 River Road
Jefferson, LA 70121
Tel: 504.733.6350
neworleans.la@wosupply.com

Houma

101 Capital Blvd.
Houma, LA 70360
Tel: 985.772.7010
houma.la@wosupply.com

New Jersey

Linden
7 West Baltimore Ave.
Linden, NJ 07036
Tel: 908.486.5338
linden.nj@wosupply.com

Pennsylvania

Philadelphia
950 Henderson Blvd.
Folcroft, PA 19032
Tel: 610.586.8070
philadelphia.pa@wosupply.com

South Carolina

Charleston
1670 Drydock Ave Building #9
North Charleston, SC 29405
Tel: 843.747.6347
charleston.sc@wosupply.com

Texas

Houston
8000 Market Street
Ste. 220
Houston, TX 77029
Tel: 832.386.9300
houston.tx@wosupply.com

Virginia

Norfolk
5901 Thurston Ave.
Virginia Beach, VA 23455
Tel: 757.217.2800
norfolk.va@wosupply.com

Washington

Seattle
7745 1st Ave. S.
Seattle, WA 98106
Tel: 206.223.0584
seattle.wa@wosupply.com

Canada

Vancouver
590 Ebury Place,
Unit #102
Delta, BC V3M 6K7
Tel: 604.525.9505
vancouver.bc@wosupply.com

Halifax

133 Ilsley Avenue, Unit LM
Dartmouth, NS
B3B1S9
Tel: 902.481.7333
halifax@wosupply.com



wosupply.com

July 2015